



17301xx35

MagI³C Power Module

FDSM - Fixed Step Down Regulator Module

6V - 36V / 1A / 3.3V, 5V or 12V Output

DESCRIPTION

The FDSM series of the MagI³C Power Module family is a fixed output voltage, fully integrated DC-DC power supply including the controller IC, inductor and capacitors all in one package.

The module requires only an input capacitor and no other external components for operation, reducing design effort and complexity to a minimum.

The FDSM ensures fast time to market and low development costs.

It is pin compatible with the common 78xx linear regulator series. The high efficiency reduces the power dissipation and in many cases a heatsink and assembly parts are unnecessary.

12V to 3.3V conversion achieves up to 87% efficiency. 12V to 5V conversion achieves up to 92% efficiency. 24V to 12V conversion achieves up to 94% efficiency.

The standard THT (10.4 x 11.6 x 8mm) package allows for easy assembly.

TYPICAL APPLICATIONS

- Point-of-Load DC-DC applications from 9V, 12V, 15V, 18V and 24V industrial rails
- Replacement for linear regulators
- Interface and microcontroller supplies
- General purpose

FEATURES

- Peak efficiency up to 94%
- Current capability up to 1A
- Input voltage range: 6V to 36V
- Output voltage: 3.3V (173010335), 5V (173010535) or 12V (173011235)
- Output voltage accuracy: $\pm 4\%$ max
- No minimum load required
- Partially integrated input and output capacitors
- Integrated inductor
- Low output voltage ripple ($<20\text{mV}_{\text{pp}}$)
- Fixed 520kHz switching frequency
- Current mode control
- Pulse skipping for high efficiency at light loads
- Internal soft-start
- Thermal shutdown
- Short circuit protection
- Cycle by cycle current limit
- Pin compatible with the FDSM power modules series
- Operating ambient temperature range: -40°C to 85°C
- RoHS & REACH compliant
- Case and potting material UL 94 Class V0 (flammability testing) certified
- Complies with EN55032 class B conducted and radiated emissions standard

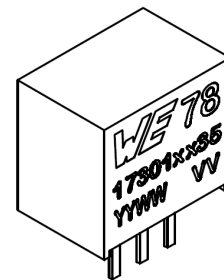

TYPICAL CIRCUIT DIAGRAM

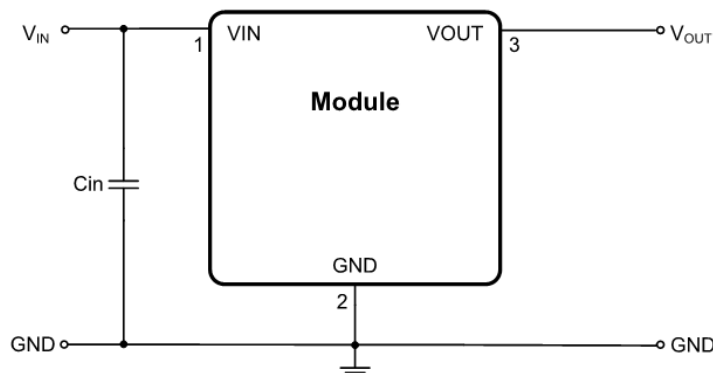

17301xx35

MagI³C Power Module

FDSM - Fixed Step Down Regulator Module



Pinout

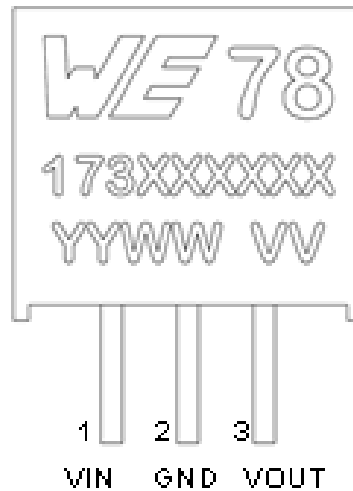

MARKING DESCRIPTION

MARKING	DESCRIPTION
WE	Würth Elektronik eiSos GmbH & Co. KG
78	Indicates compatibility with 78xx linear regulator
17301xx35	Order code
YY	Year
WW	Calendar week
VV	Output voltage (3.3V, 5V or 12V)

PIN DESCRIPTION

SYMBOL	NUMBER	TYPE	DESCRIPTION
VIN	1	Power	The supply input pin is a terminal for an unregulated input voltage source. It is recommended to use a 10 μ F/50V input capacitor.
GND	2	Power	Ground; reference for V _{IN} and V _{OUT} .
VOUT	3	Power	Regulated output voltage pin. There is no need for an external output capacitor.

17301xx35

MagI³C Power Module

FDSM - Fixed Step Down Regulator Module



ORDERING INFORMATION

ORDER CODE	SPECIFICATIONS	PACKAGE	PACKAGING UNIT
173010335	36V / 1A / 3.3Vout version	SIP-3	Tube with 42 pieces
173010535	36V / 1A / 5Vout version		
173011235	36V / 1A / 12Vout version		
17800FDSM	Evaluation board		

PIN COMPATIBLE FAMILY MEMBERS

ORDER CODE	SPECIFICATIONS	PACKAGE	PACKAGING UNIT
173950378	28V / 500mA / 3.3Vout	SIP-3	Tube with 42 pieces
173950578	28V / 500mA / 5Vout		
173010378	28V / 1A / 3.3Vout		
173010578	28V / 1A / 3.3Vout		
173010342	42V / 1A / 3.3Vout		
173010542	42V / 1A / 5Vout		
173950336	36V / 500mA / 3.3Vout		
173950536	36V / 500mA / 5Vout		
173010335	36V / 1A / 3.3Vout		
173010535	36V / 1A / 5Vout		

SALES INFORMATION

SALES CONTACT
<p>Würth Elektronik eiSos GmbH & Co. KG EMC & Inductive Solutions Max-Eyth-Str. 1 74638 Waldenburg Germany Tel. +49 (0) 7942 945 0 www.we-online.com/powermodules Technical support: powermodules@we-online.com</p>

17301xx35

MagI³C Power Module

FDSM - Fixed Step Down Regulator Module



ABSOLUTE MAXIMUM RATINGS

Caution:

Exceeding the listed absolute maximum ratings may affect the device negatively and may cause permanent damage.

SYMBOL	PARAMETER	LIMIT		UNIT
		MIN ⁽¹⁾	MAX ⁽¹⁾	
V _{IN}	Input pin voltage	-0.3	44	V
V _{OUT}	Output pin voltage	-0.3	44	V
T _{storage}	Assembled, non-operating storage temperature	-40	125	°C
V _{esd}	ESD Voltage (Human Body Model), according to EN61000-R-2 ⁽²⁾	-4	4	kV

OPERATING CONDITIONS

Operating conditions are conditions under which the device is intended to be functional. All values are referenced to GND.

MIN and MAX limits are valid for the recommended ambient temperature range of **-40 °C to 85 °C**. Typical values represent statistically the utmost probable values at the following conditions: V_{IN}= 6V to 36V (173010335), V_{IN}= 8V to 36V (173010535), V_{IN}= 16V to 36V (173011235), I_{OUT}= 1A⁽⁵⁾, T_A = 25 °C, unless otherwise noted.

SYMBOL	PARAMETER	MIN ⁽¹⁾	TYP ⁽³⁾	MAX ⁽¹⁾	UNIT
V _{IN}	Input Voltage (173010335)	6	-	36	V
V _{IN}	Input Voltage (173010535)	8	-	36	V
V _{IN}	Input Voltage (173011235)	16	-	36	V
T _a	Ambient temperature range	-40	-	85 ⁽⁴⁾	°C
I _{OUT}	Nominal output current	-	-	1	A
C _{OUT MAX}	Maximal output capacitance	-	-	680	μF

17301xx35

MagI³C Power Module

FDSM - Fixed Step Down Regulator Module



ELECTRICAL SPECIFICATIONS

MIN and MAX limits are valid for the recommended ambient temperature range of **-40°C to 85°C**. Typical values represent statistically the utmost probable values at the following conditions: $V_{IN} = 24V$ (173010335, 173010535 and 173011235), $I_{OUT} = 1A^{(5)}$, $T_A = 25°C$, unless otherwise noted.

SYMBOL	PARAMETER	TEST CONDITIONS	LIMIT			UNIT	
			MIN ⁽¹⁾	TYP ⁽³⁾	MAX ⁽¹⁾		
Output Current							
I_{CL}	Current limit threshold	$V_{IN} = 24V$	2.5	3.2	3.8	A	
Output Voltage							
V_{OUT}	Regulated output voltage	173010335	-	3.3	-	V	
	Regulated output voltage	173010535	-	5	-	V	
	Regulated output voltage	173011235	-	12	-	V	
	Line regulation	$I_{OUT} = 1A$	-0.4	± 0.2	0.4	%	
	Load Regulation	10% to 100% load	-0.6	± 0.4	0.6	%	
	Total output voltage regulation	Full load, input voltage range	-4	± 2	4	%	
	External $C_{OUT} = 22\mu F$ X5R, 20MHz BWL						
	Output voltage ripple	$V_{OUT} = 3.3V, I_{OUT} = 1A$		-	13.5	-	mV _{pp}
		$V_{OUT} = 5V, I_{OUT} = 1A$		-	17.5	-	mV _{pp}
$V_{OUT} = 12V, I_{OUT} = 1A$		-	25	-	mV _{pp}		
Switching Frequency							
f_{SW}	Switching frequency	$V_{IN} = 12V$, Continuous conduction mode (CCM)	-	520	-	kHz	
Input Current							
I_{IN}	No load input current	Operating, switching	-	0.1	1	mA	
Efficiency							
η	Efficiency, $I_{OUT} = 1A$	$V_{IN} = 6V, V_{OUT} = 3.3V$	-	92	-	%	
		$V_{IN} = 36V, V_{OUT} = 3.3V$	-	81	-	%	
		$V_{IN} = 8V, V_{OUT} = 5V$	-	94	-	%	
		$V_{IN} = 36V, V_{OUT} = 5V$	-	86	-	%	
		$V_{IN} = 16V, V_{OUT} = 12V$	-	95	-	%	
		$V_{IN} = 36V, V_{OUT} = 12V$	-	92	-	%	

17301xx35

MagI³C Power Module

FDSM - Fixed Step Down Regulator Module



RoHS, REACH

RoHS directive		Directive 2011/65/EU of the European Parliament and the Council of June 8th, 2011 on the restriction of the use of certain hazardous substances in electrical and electronic equipment.
REACH directive		Directive 1907/2006/EU of the European Parliament and the Council of June 1st, 2007 regarding the Registration, Evaluation, Authorization and Restriction of Chemicals (REACH).

PACKAGE SPECIFICATIONS

ITEM	PARAMETER	TYP ⁽³⁾	UNIT
Case	Black flame-retardant and heat-resistant plastic (UL94 V-0)	-	-
Potting material	Silicone, UL94V-0	-	-
Weight		1.8	g
Vibration	5g for 20min	MIL-STD-202, Method 204	

NOTES

- (1) Min and Max are 100% production tested at 25° C. Limits over the operating temperature range are guaranteed through correlation using Statistical Quality Control (SQC) methods.
- (2) The human body model is a 100pF capacitor discharged through a 1.5 kΩ resistor into each pin. Test method is per JESD-22-114.
- (3) Typical numbers are valid at 25° C ambient temperature and represent statistically the utmost probability assuming the Gaussian distribution.
- (4) Depending on load current, see derating diagram.
- (5) Measured without heatsink, no airflow.

17301xx35**MagI³C** Power Module**FDSM** - Fixed Step Down Regulator Module

TYPICAL PERFORMANCE CURVES

If not otherwise specified, the following conditions apply: $V_{IN} = 24V$; $V_{OUT} = 3.3V$ (173010335), $V_{OUT} = 5V$ (173010535) and $V_{OUT} = 12V$ (173011235); $I_{OUT} = 1A^{(5)}$; $T_{AMB} = 25^{\circ}C$.

RADIATED AND CONDUCTED EMISSIONS EN55032 (CISPR-32) CLASS B COMPLIANT

The 173010335, 173010535 and 173011235 power modules are tested with a standard EMC configuration (1m wire between the module and the load) to give more realistic information about implementation in the applications. The test setup is based on CISPR16 with the limit values CISPR32.

Measured with module on an Evaluation Board 17800FDSM in a Fully Anechoic Room (FAR) at 3m antenna distance.

TEST SETUP

Input wire length:

- Radiated Emission: 160cm (80cm Horizontal + 80cm Vertical)
- Conducted Emission: 80cm

Output wire length:

- Long wire (with input filter): 1m

17301xx35

MagI³C Power Module

FDSM - Fixed Step Down Regulator Module



RADIATED AND CONDUCTED EMISSIONS - 173010335

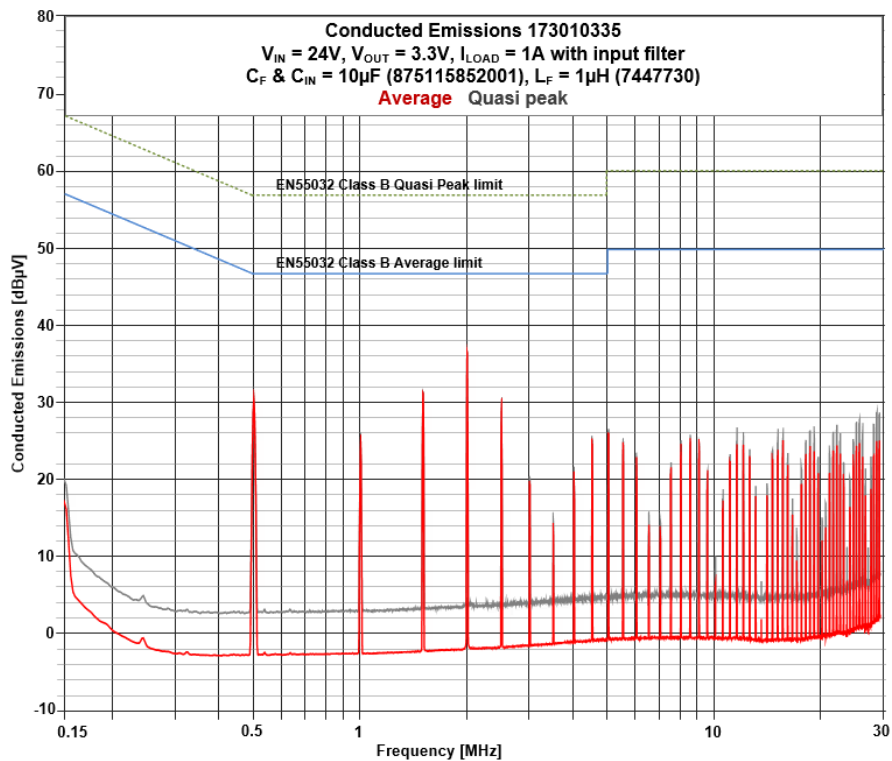
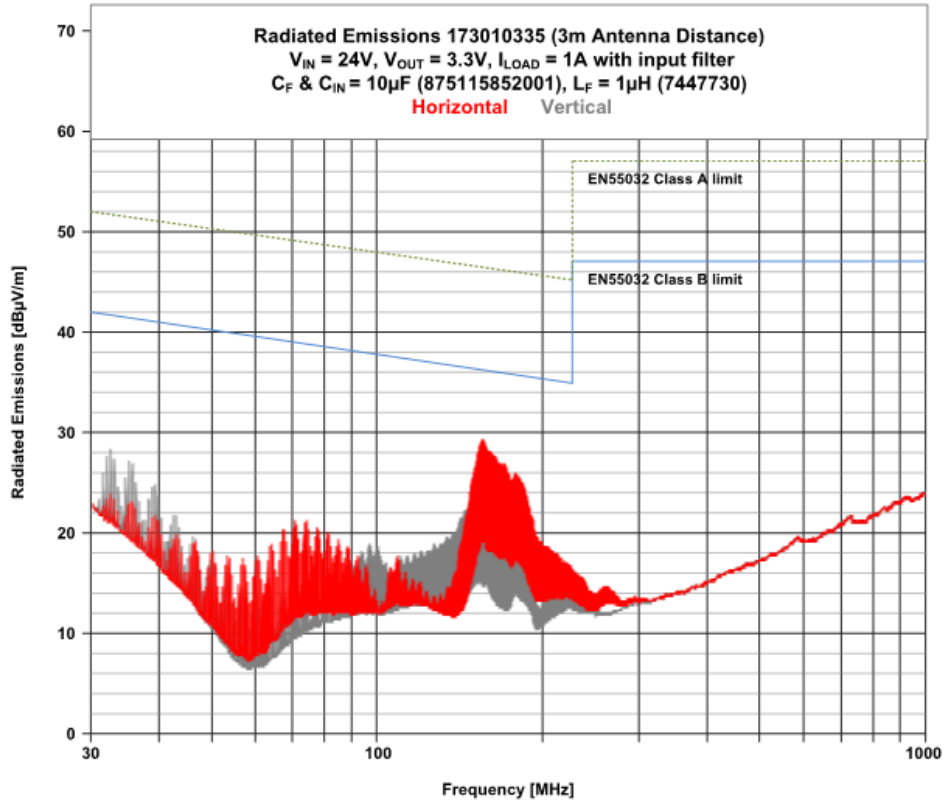

17301xx35

MagI³C Power Module

FDSM - Fixed Step Down Regulator Module



RADIATED AND CONDUCTED EMISSIONS - 173010535

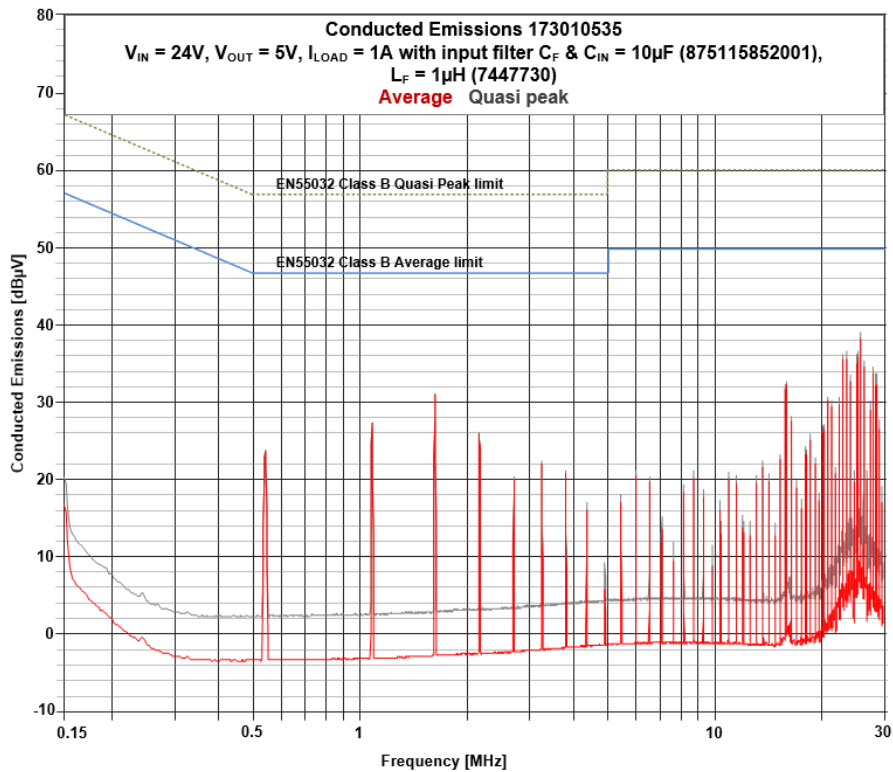
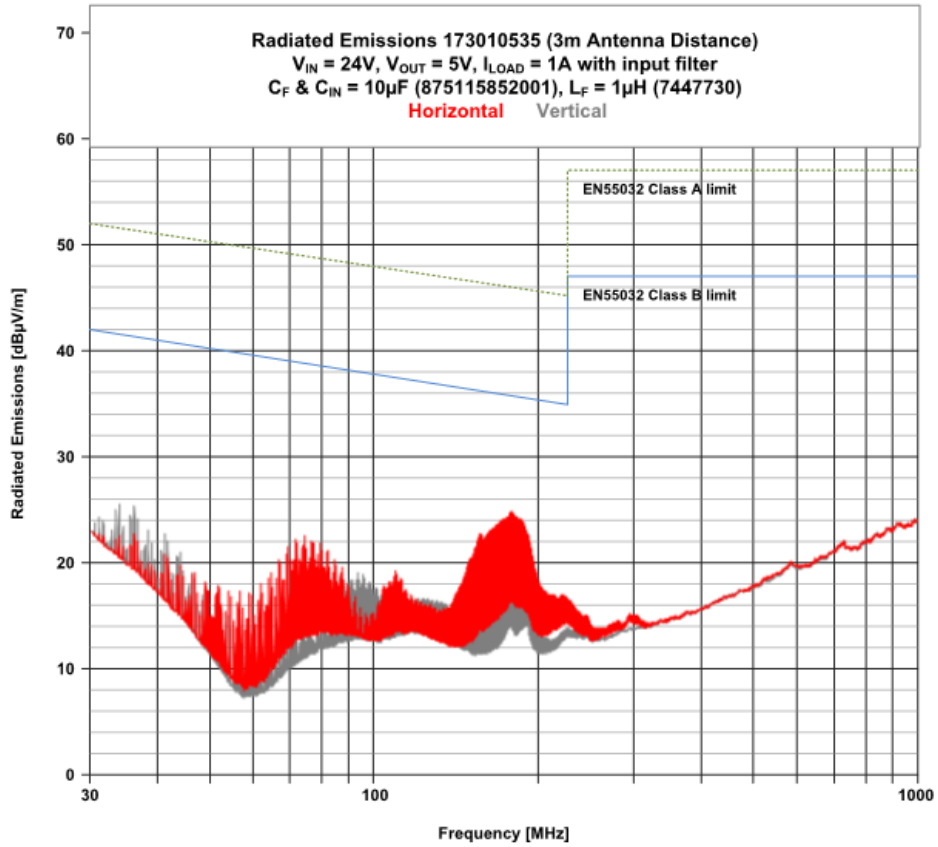

17301xx35

MagI³C Power Module

FDSM - Fixed Step Down Regulator Module



RADIATED AND CONDUCTED EMISSIONS - 173011235

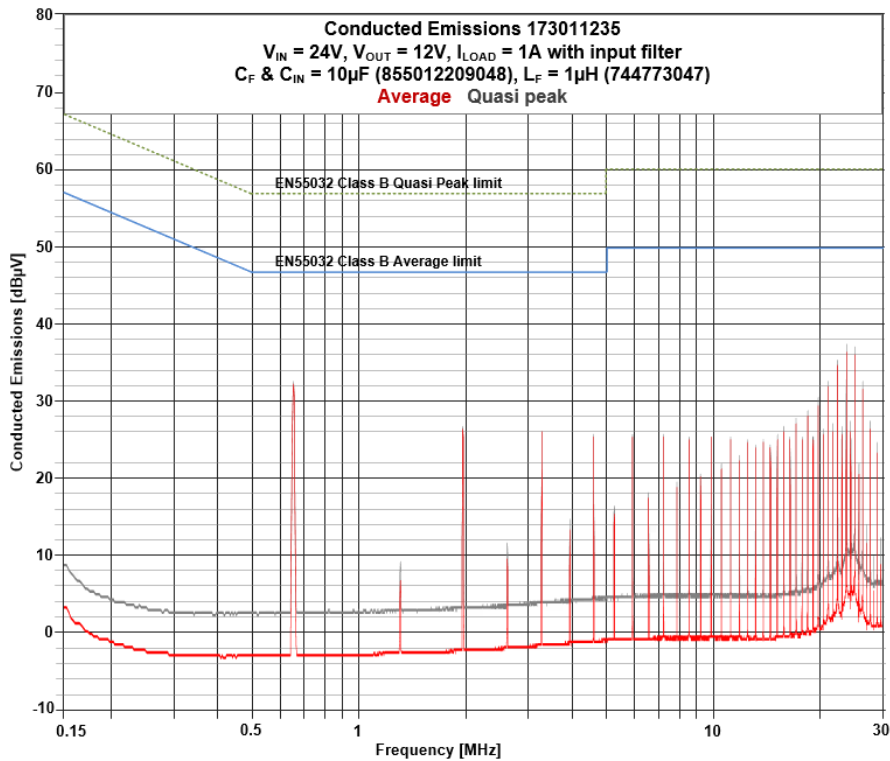
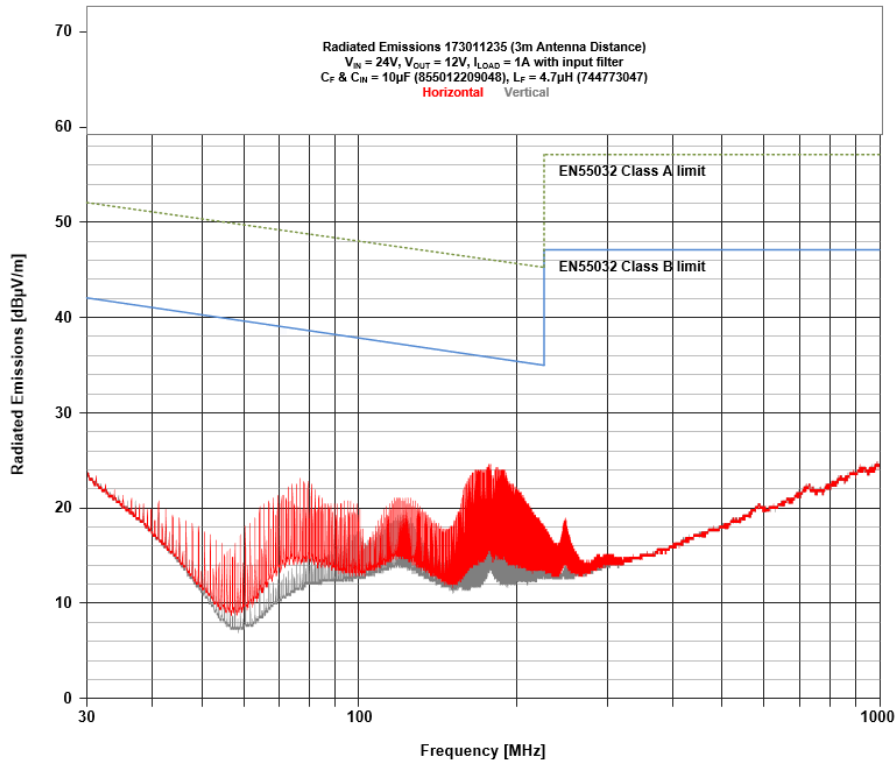

17301xx35

MagI³C Power Module

FDSM - Fixed Step Down Regulator Module

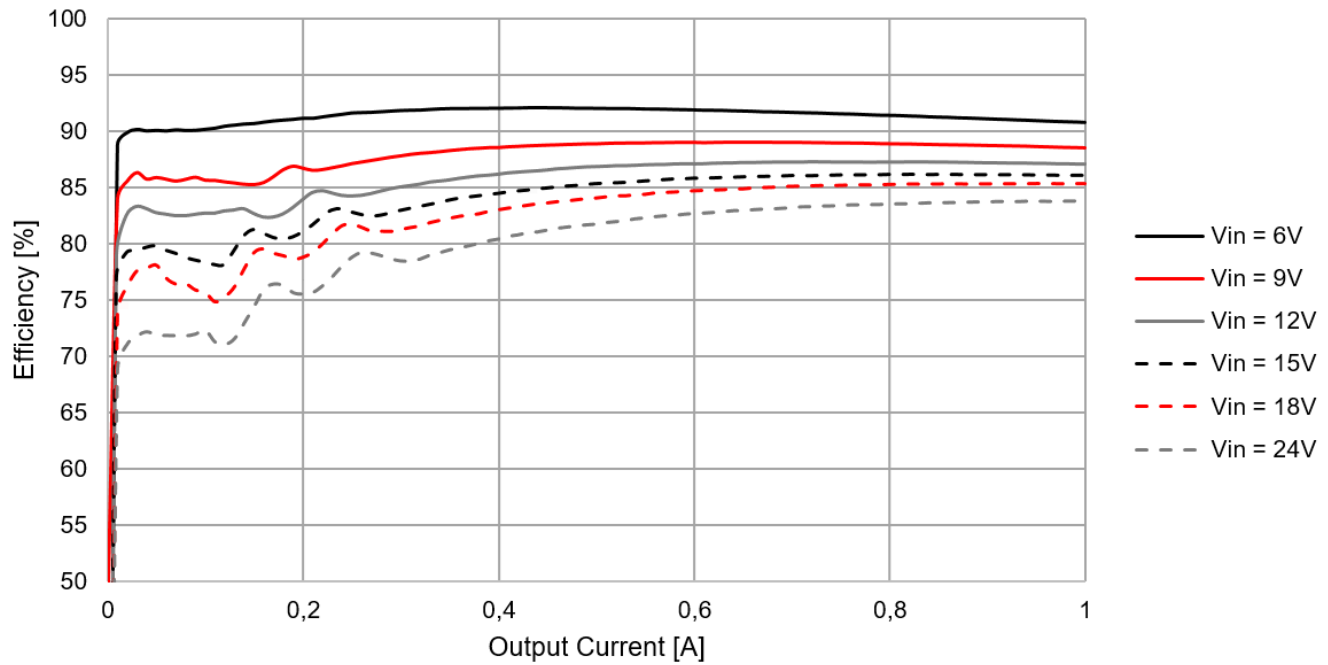
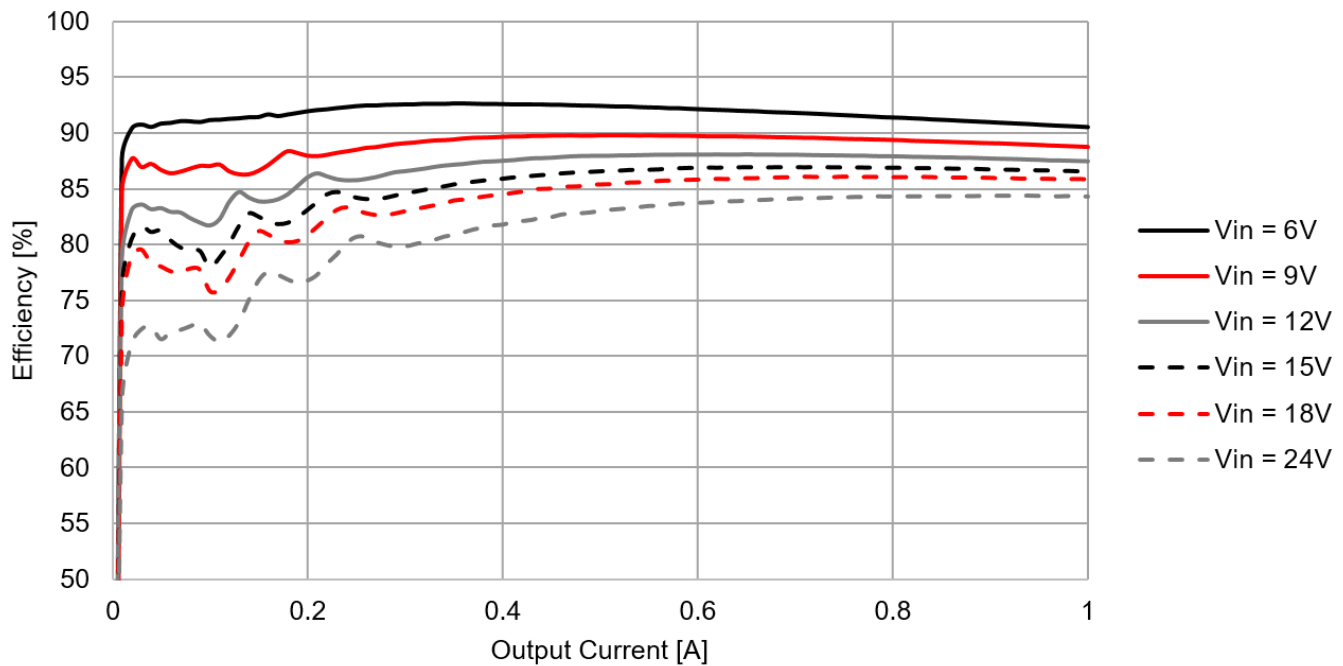

EFFICIENCY - 173010335

173010335 $V_{OUT} = 3.3V$, $f_{SW} = 520kHz$, $T_A = 25^\circ C$ 173010335 $V_{OUT} = 3.3V$, $f_{SW} = 520kHz$, $T_A = 85^\circ C$ 

17301xx35

MagI³C Power Module

FDSM - Fixed Step Down Regulator Module



EFFICIENCY - 173010535

173010535 $V_{OUT} = 5V$, $f_{SW} = 520kHz$, $T_A = 25^\circ C$

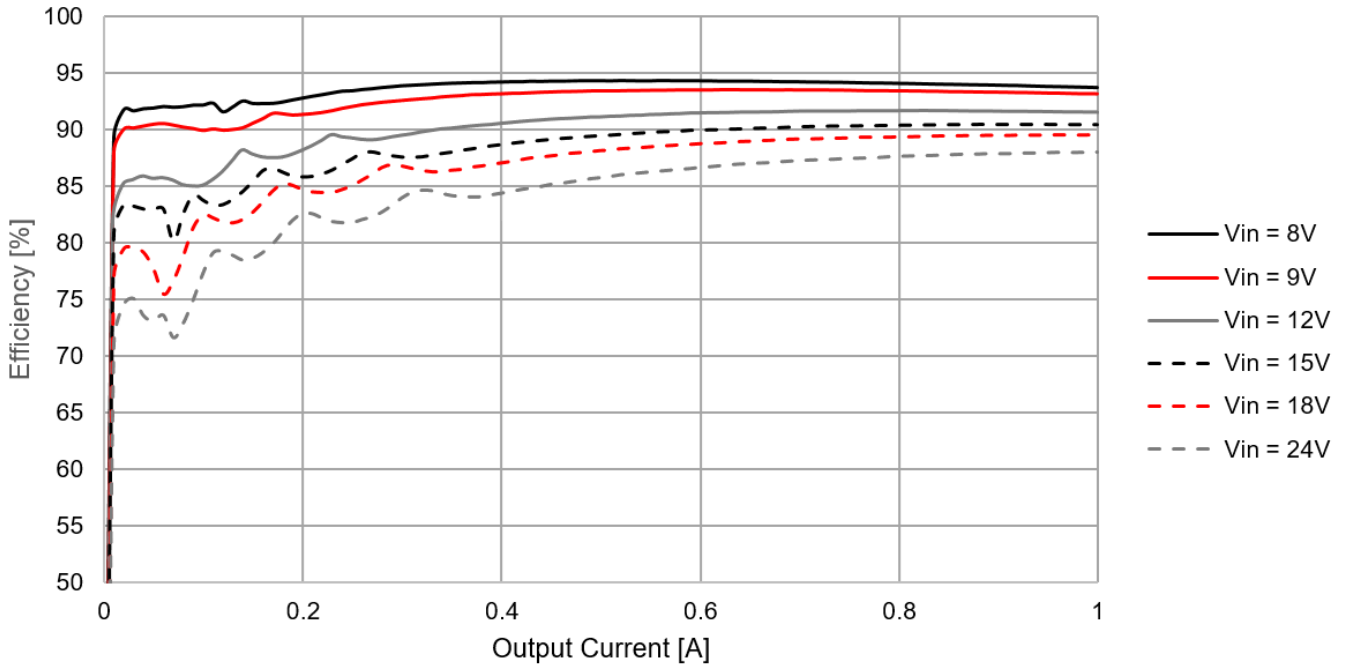

173010535 $V_{OUT} = 5V$, $f_{SW} = 520kHz$, $T_A = 85^\circ C$

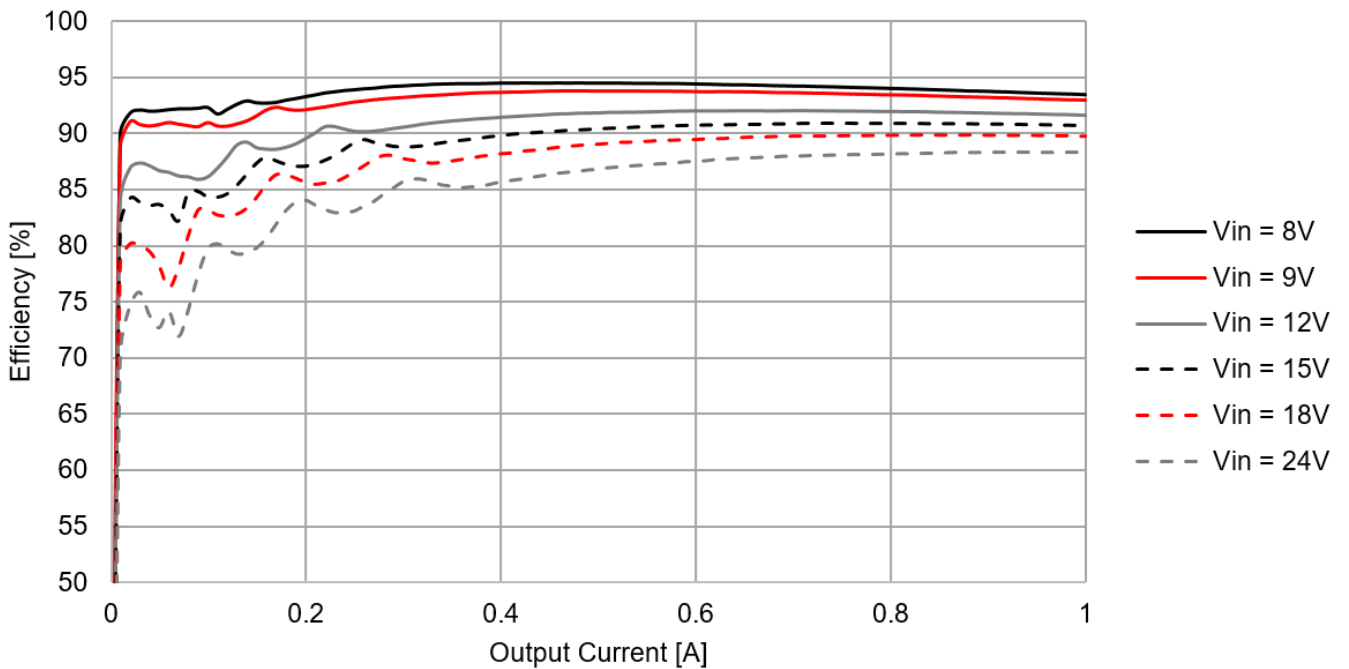

17301xx35

MagI³C Power Module

FDSM - Fixed Step Down Regulator Module



EFFICIENCY - 173011235

173011235 $V_{OUT} = 12V$, $f_{SW} = 520kHz$, $T_A = 25^\circ C$

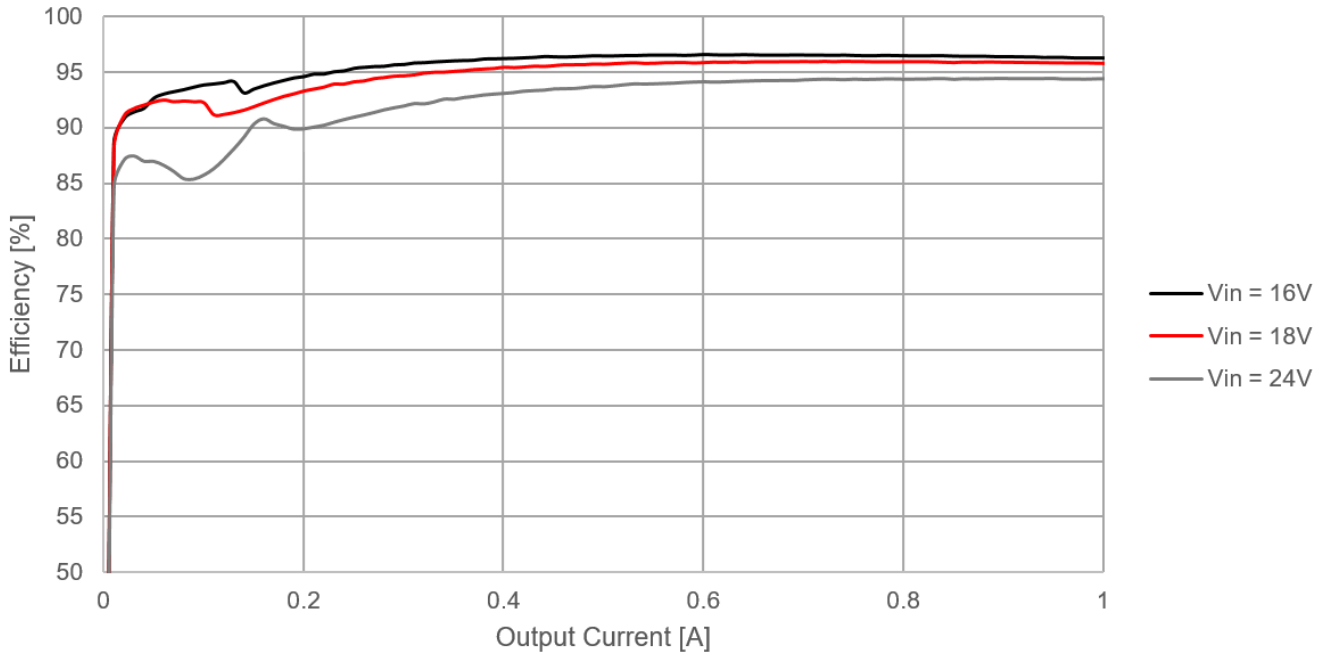

173011235 $V_{OUT} = 12V$, $f_{SW} = 520kHz$, $T_A = 85^\circ C$

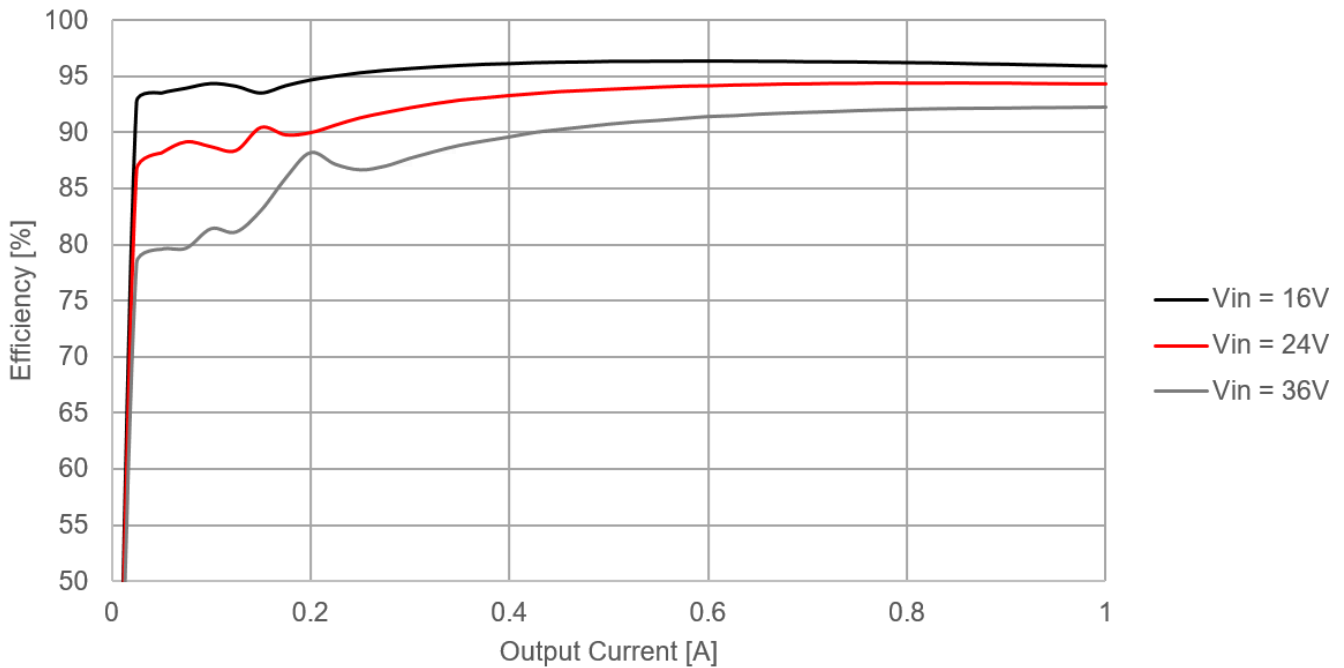

17301xx35

Magi³C Power Module

FDSM - Fixed Step Down Regulator Module



POWER DISSIPATION - 173010335

173010335 $V_{OUT} = 3.3V$, $f_{SW} = 520kHz$, $T_A = 25^\circ C$

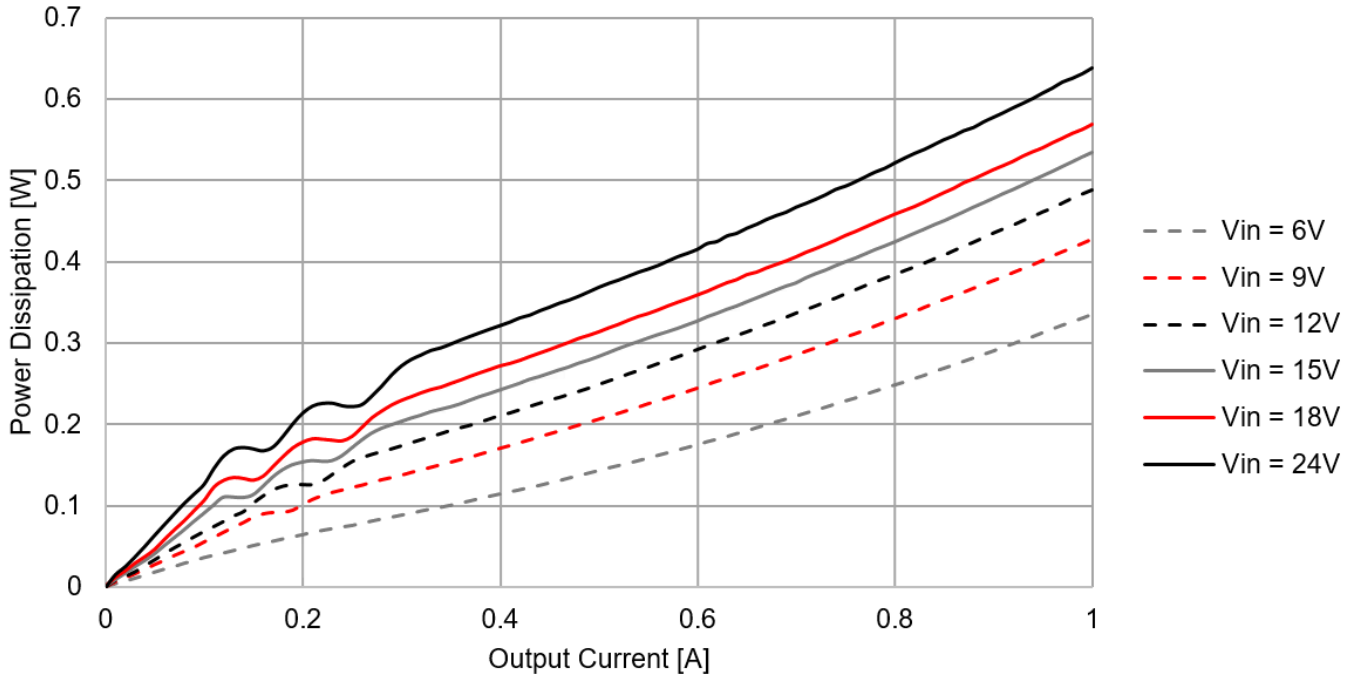

173010335 $V_{OUT} = 3.3V$, $f_{SW} = 520kHz$, $T_A = 85^\circ C$

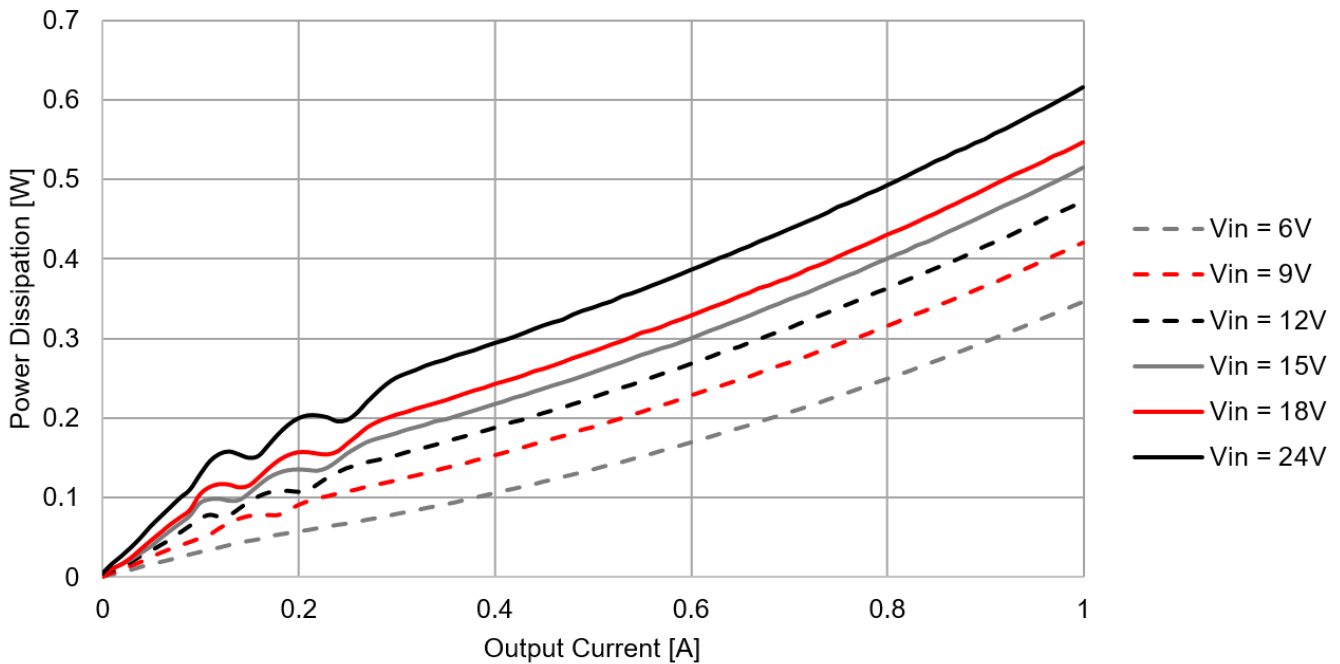

17301xx35

MagI³C Power Module

FDSM - Fixed Step Down Regulator Module



POWER DISSIPATION - 173010535

173010535 $V_{OUT} = 5V$, $f_{SW} = 520kHz$, $T_A = 25^\circ C$

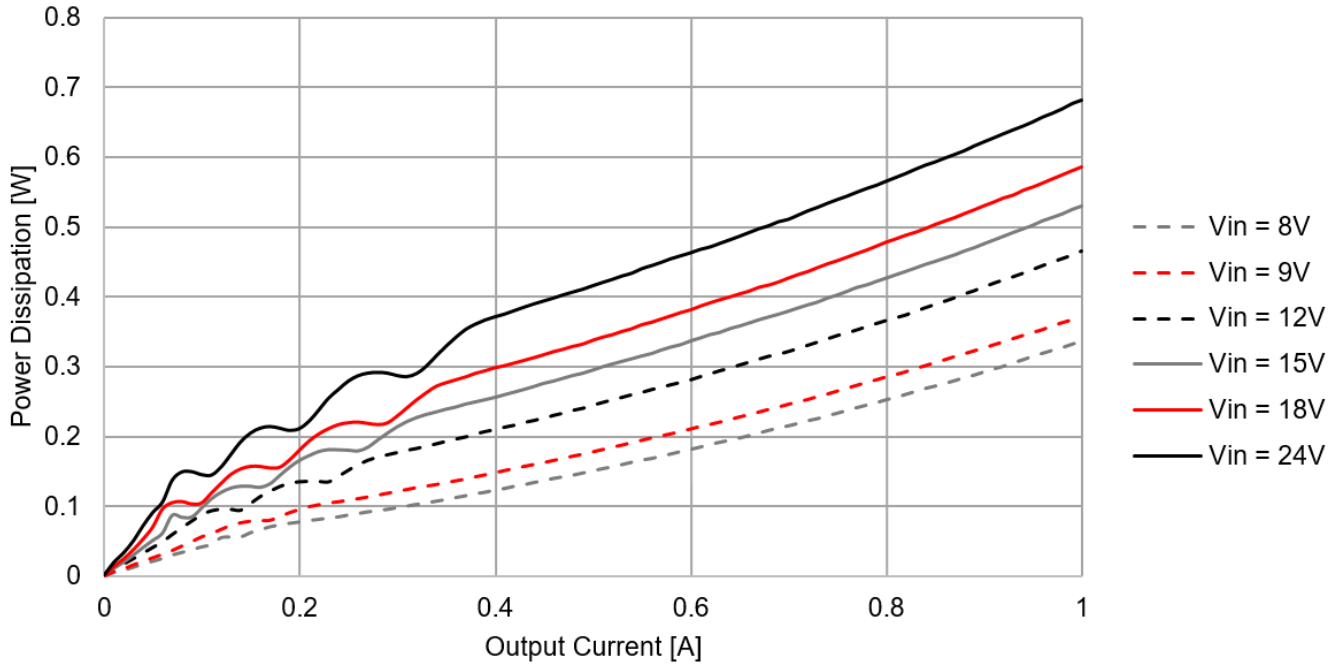

173010535 $V_{OUT} = 5V$, $f_{SW} = 520kHz$, $T_A = 85^\circ C$

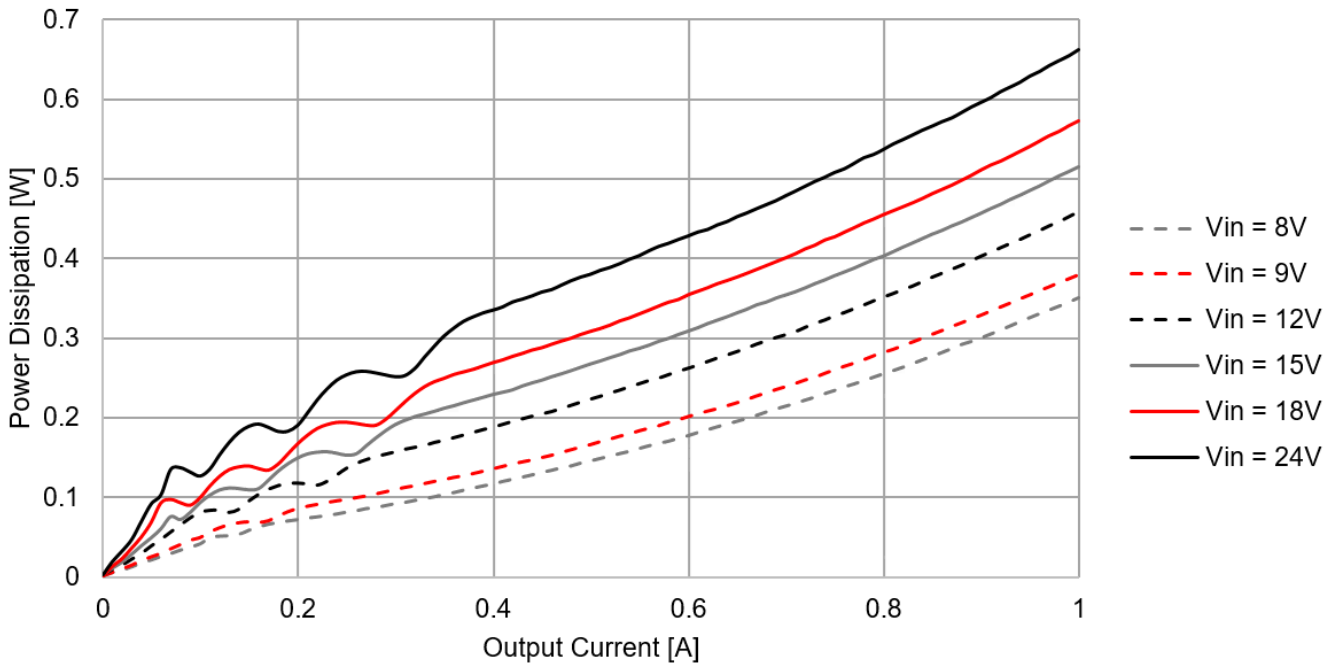

17301xx35

MagI³C Power Module

FDSM - Fixed Step Down Regulator Module



POWER DISSIPATION - 173011235

173011235 $V_{OUT} = 12V$, $f_{SW} = 520kHz$, $T_A = 25^\circ C$

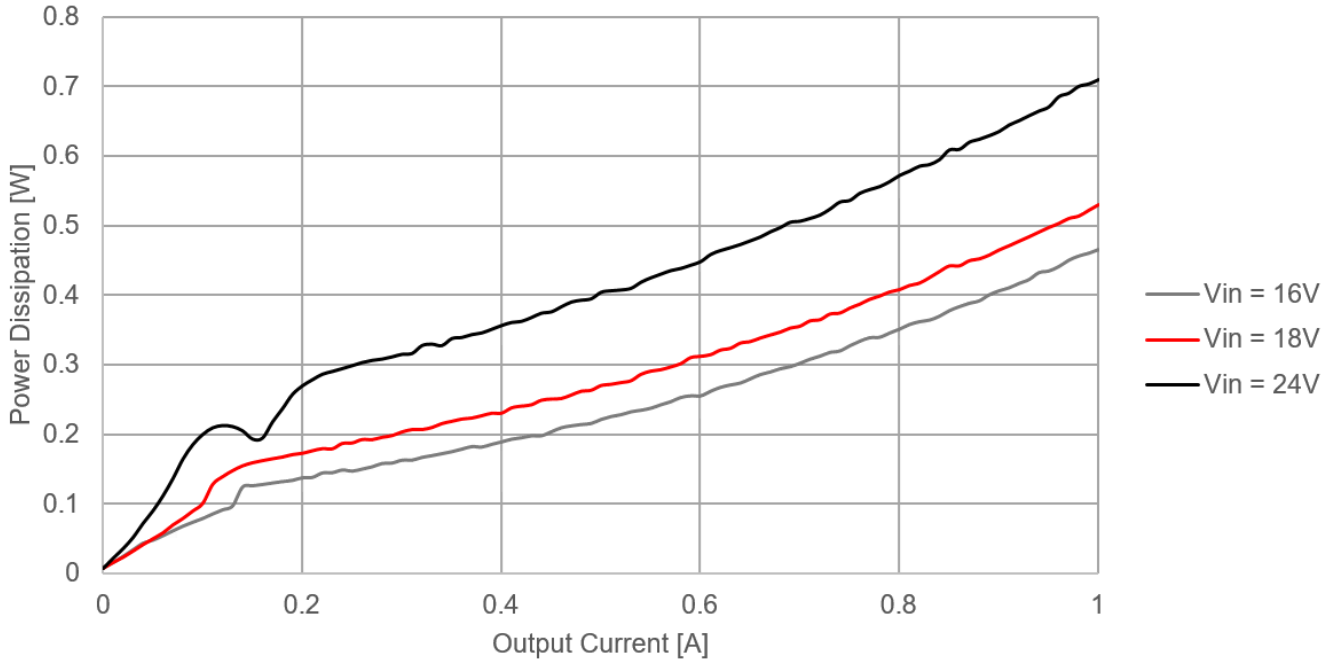

173011235 $V_{OUT} = 12V$, $f_{SW} = 520kHz$, $T_A = 25^\circ C$

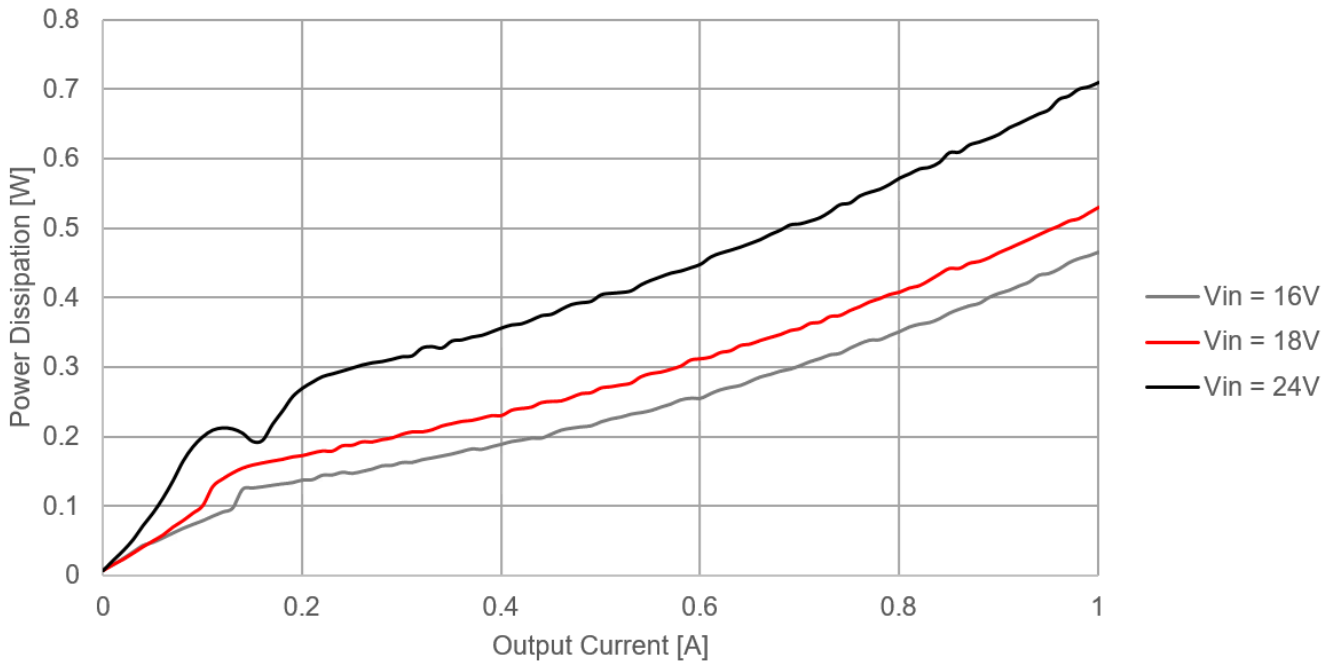

17301xx35**MagI³C** Power Module**FDSM** - Fixed Step Down Regulator Module**THERMAL DERATING - 17301xx35**

17301xx35 Output Power Thermal Derating

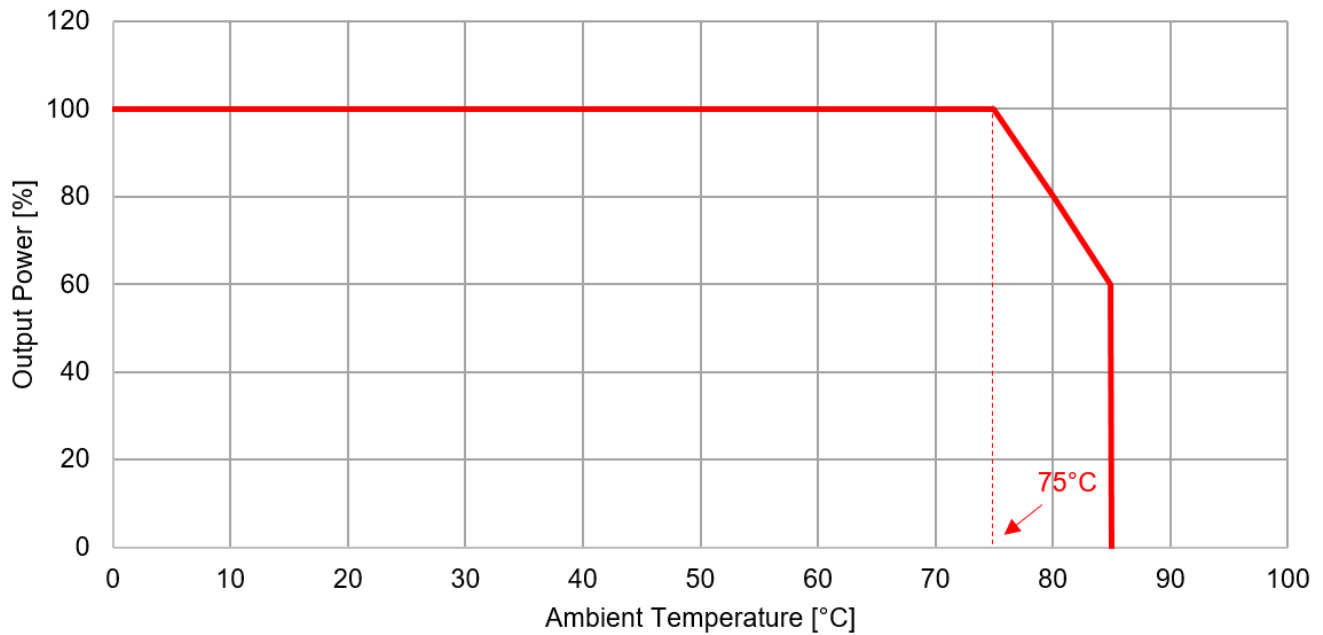
 $V_{IN} = 24V, I_{OUT} = 1A, f_{SW} = 520kHz$ 

17301xx35

MagI³C Power Module

FDSM - Fixed Step Down Regulator Module



LOAD REGULATION - 173010335

173010335 Load Regulation $V_{OUT} = 3.3V$, $T_A = 25^\circ C$

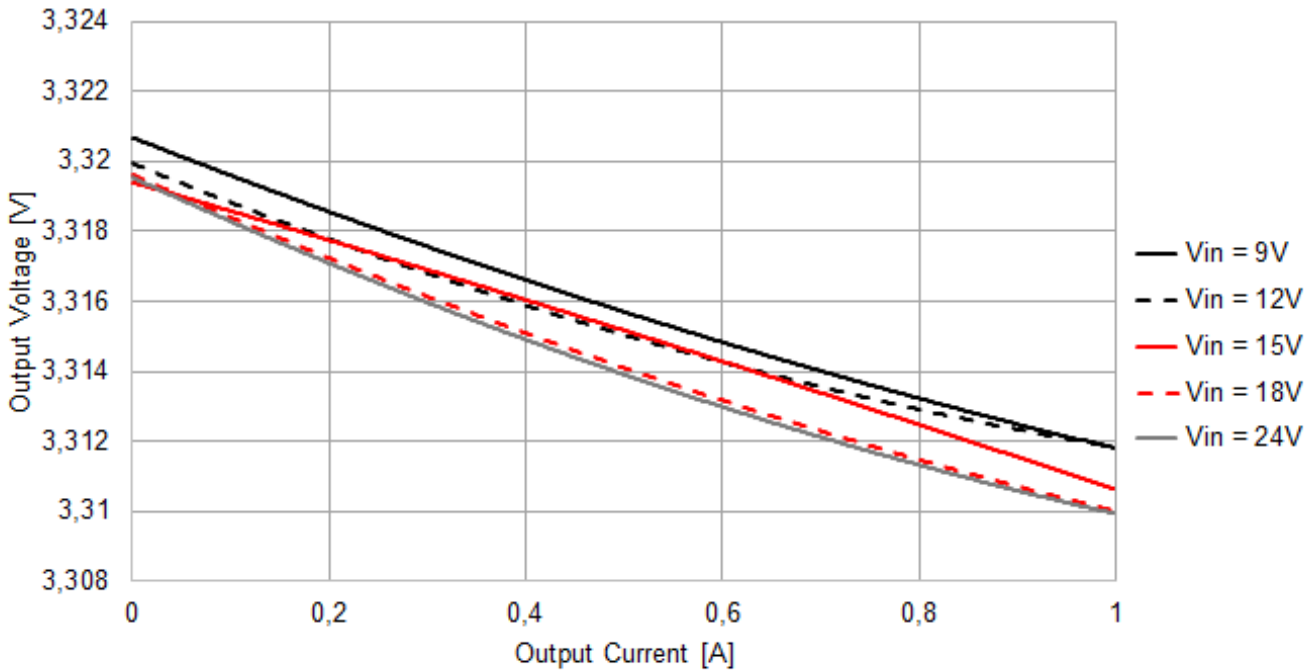

173010335 Load Regulation $V_{OUT} = 3.3V$, $T_A = 85^\circ C$

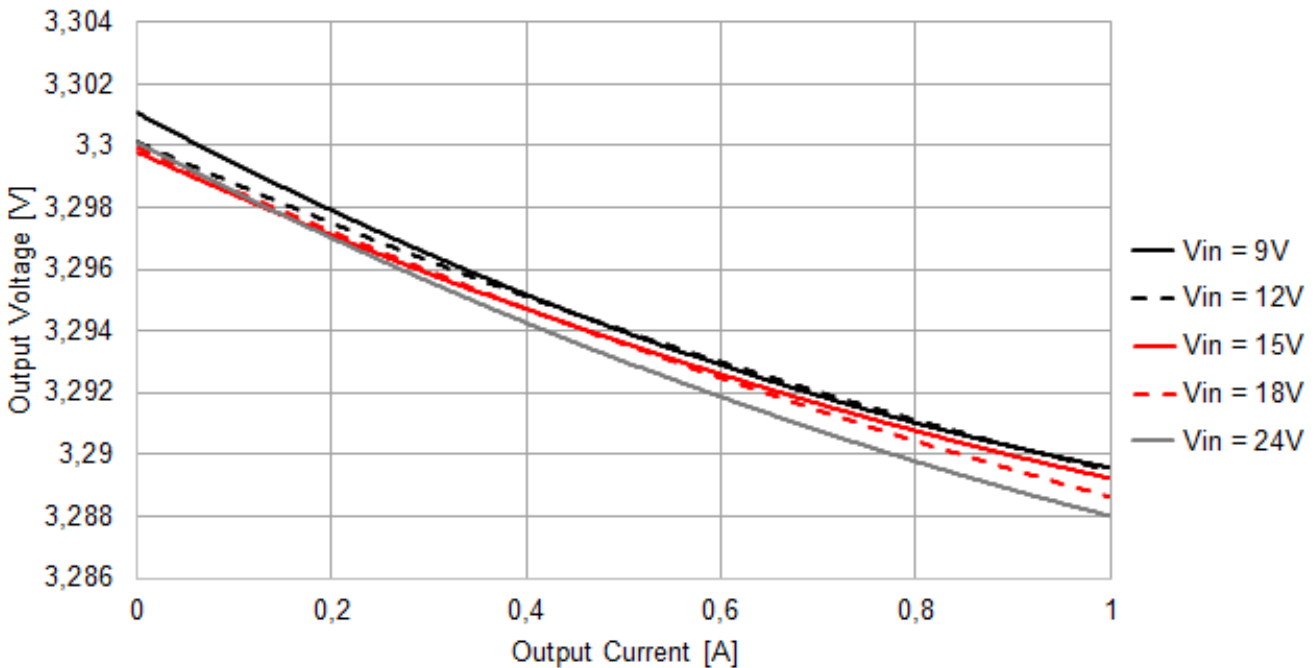

17301xx35

MagI³C Power Module

FDSM - Fixed Step Down Regulator Module

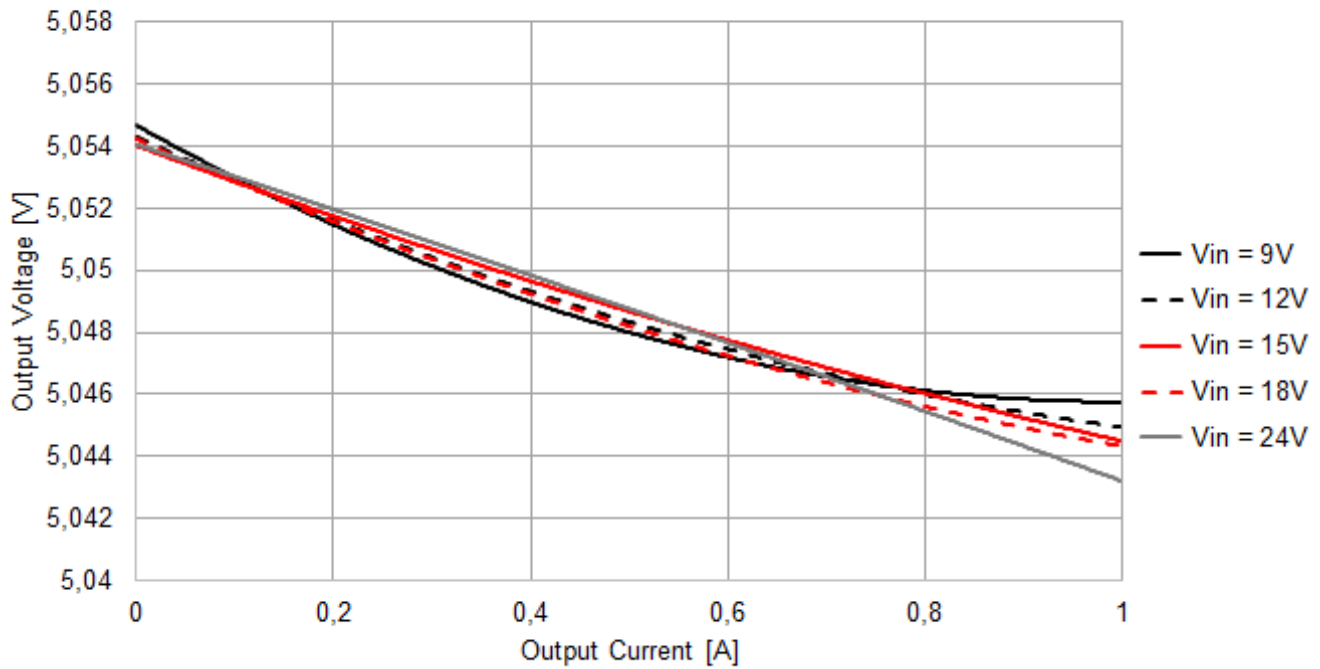
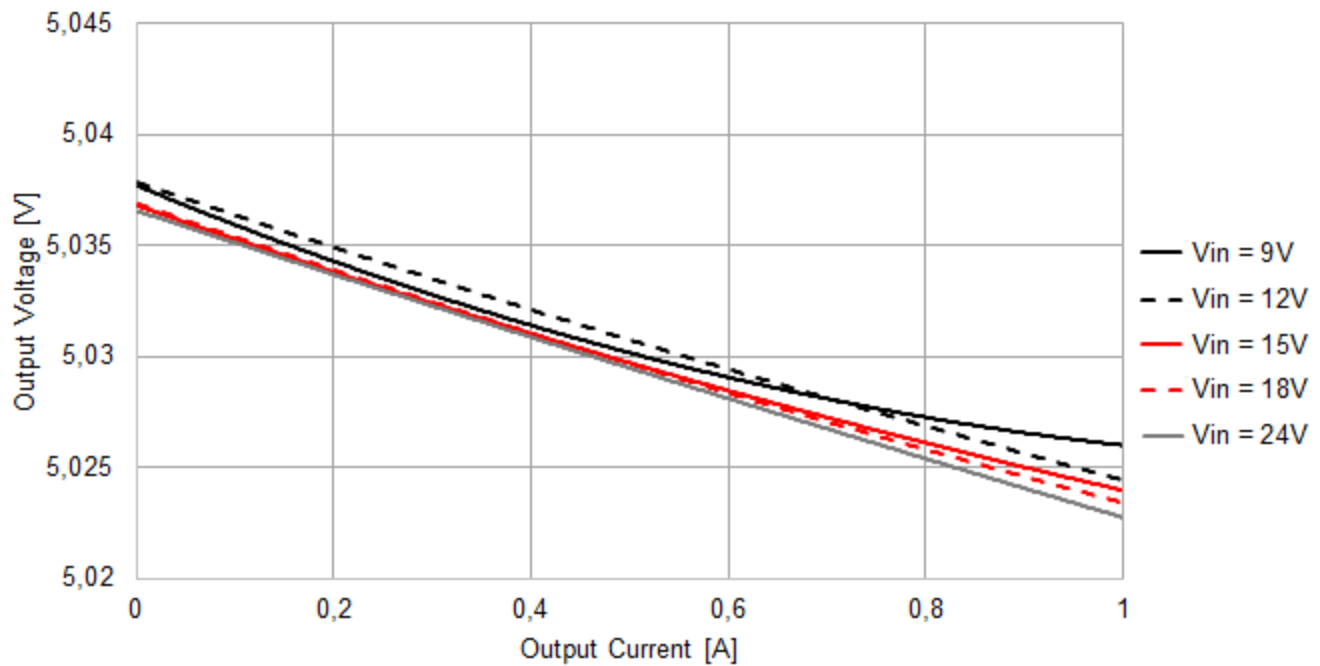

LOAD REGULATION - 173010535

173010535 Load Regulation $V_{OUT} = 5V$, $T_A = 25^\circ C$ 173010535 Load Regulation $V_{OUT} = 5V$, $T_A = 85^\circ C$ 

17301xx35

MagI³C Power Module

FDSM - Fixed Step Down Regulator Module



LOAD REGULATION - 173011235

173011235 Load Regulation $V_{OUT} = 12V$, $T_A = 25^\circ C$

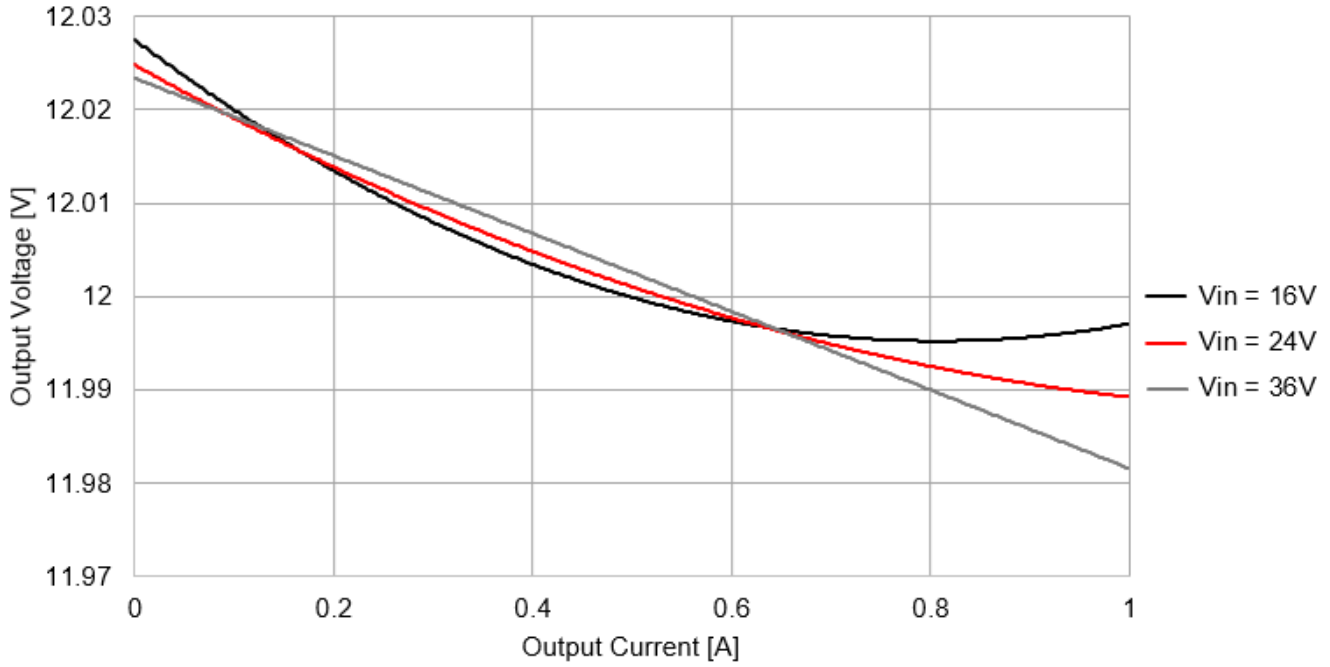

173011235 Load Regulation $V_{OUT} = 12V$, $T_A = 85^\circ C$

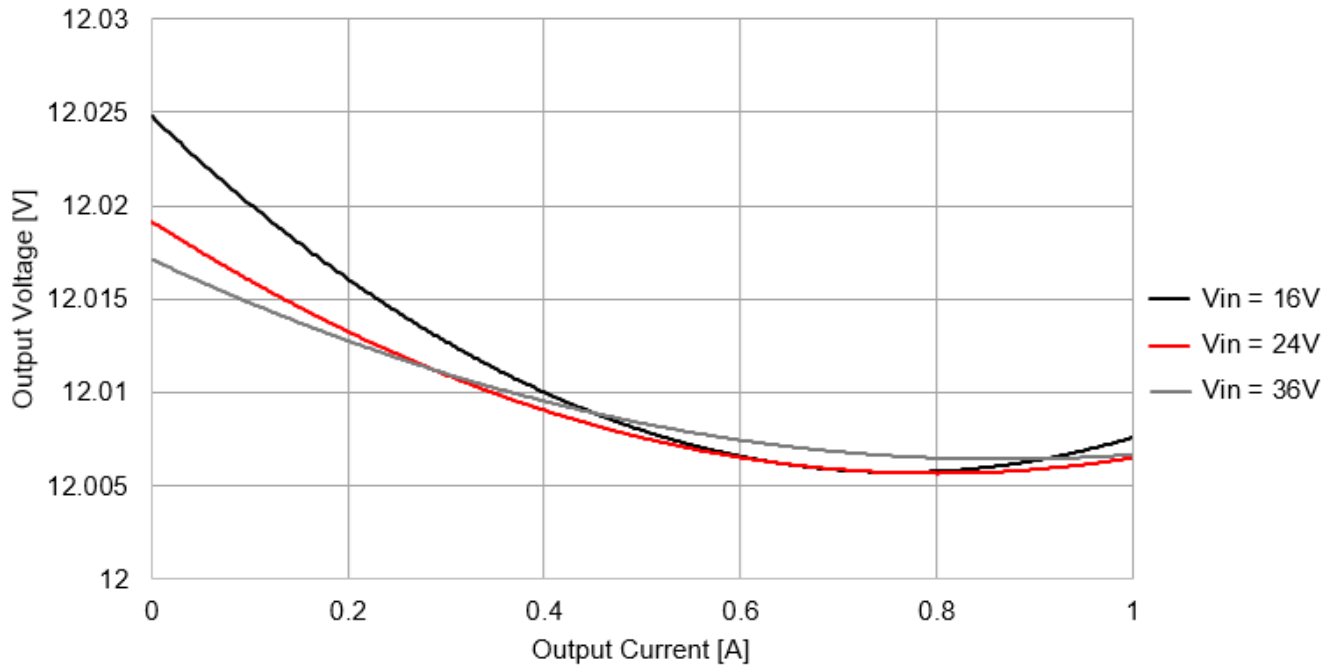

17301xx35

MagI³C Power Module

FDSM - Fixed Step Down Regulator Module

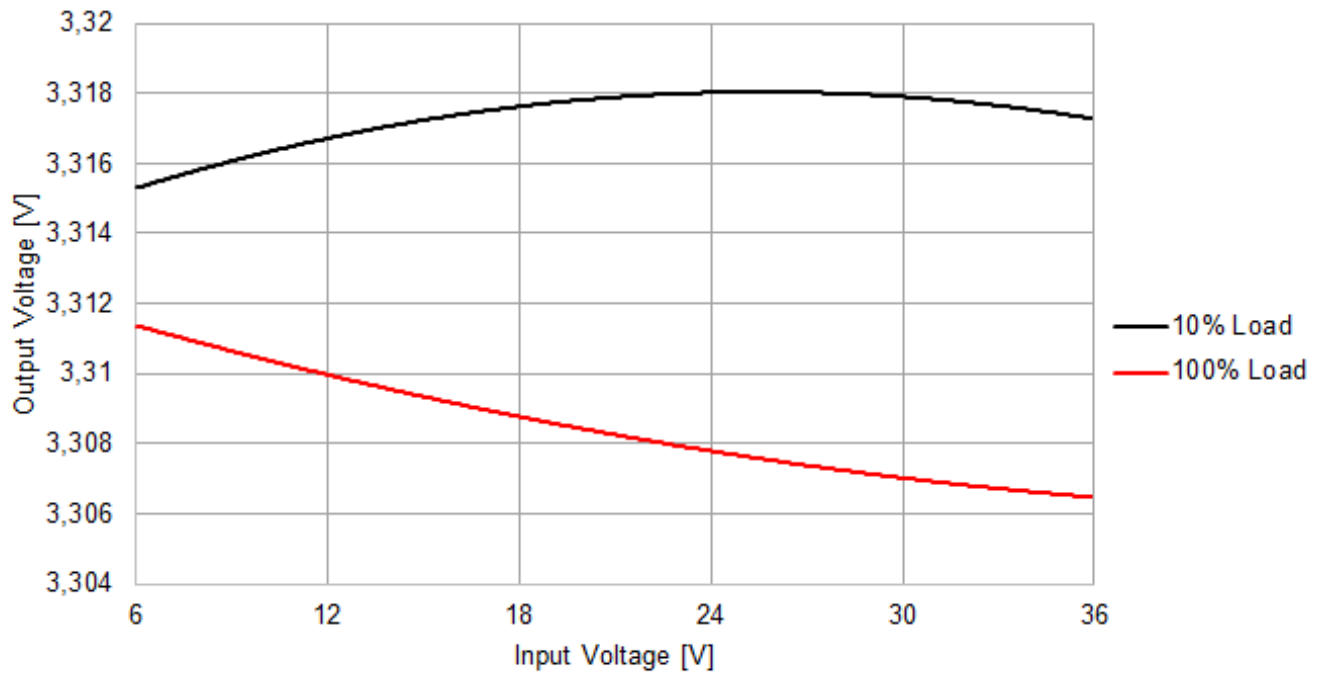
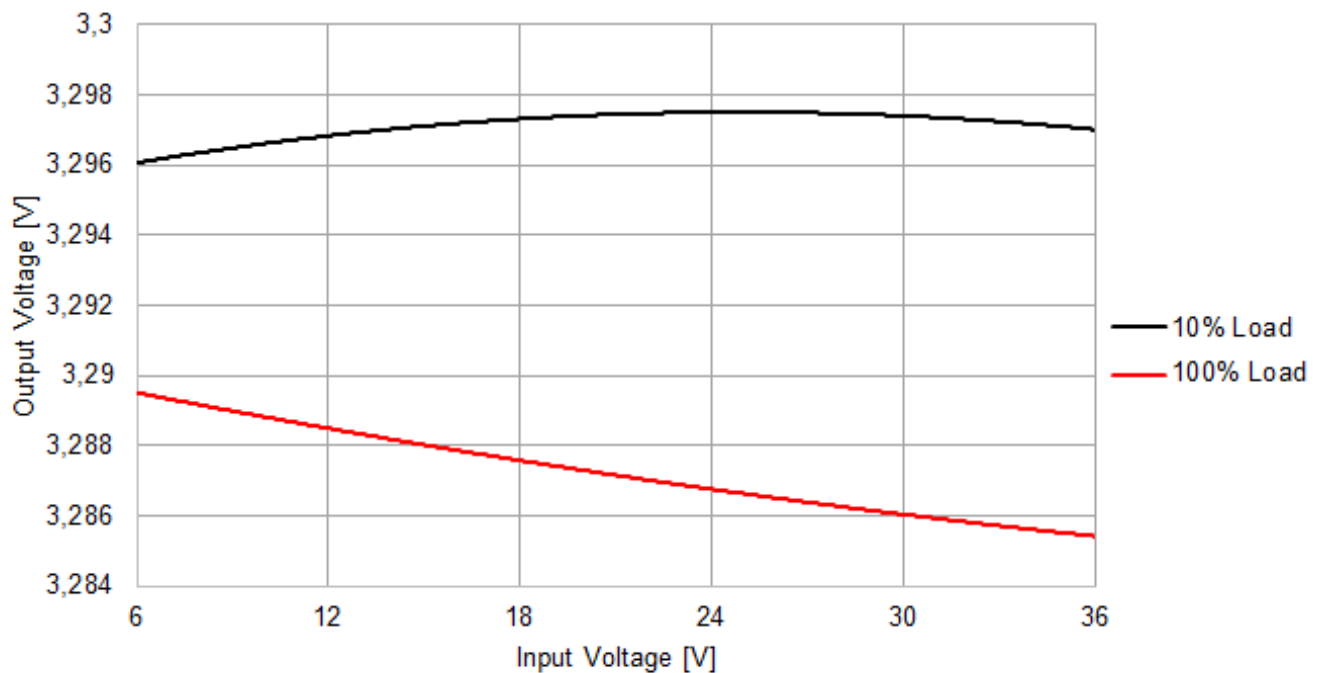

LINE REGULATION - 173010335

173010335 Line Regulation $V_{OUT} = 3.3V$, $T_A = 25^\circ C$ 173010335 Line Regulation $V_{OUT} = 3.3V$, $T_A = 85^\circ C$ 

17301xx35

Magl³C Power Module

FDSM - Fixed Step Down Regulator Module

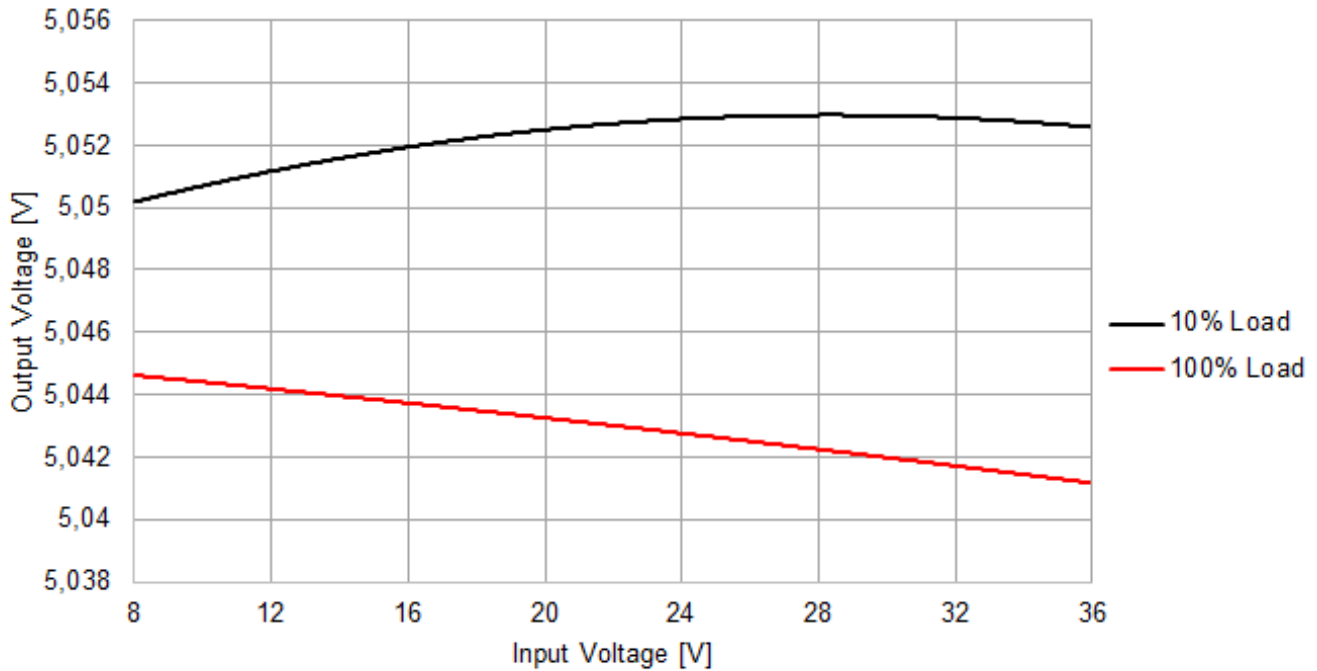
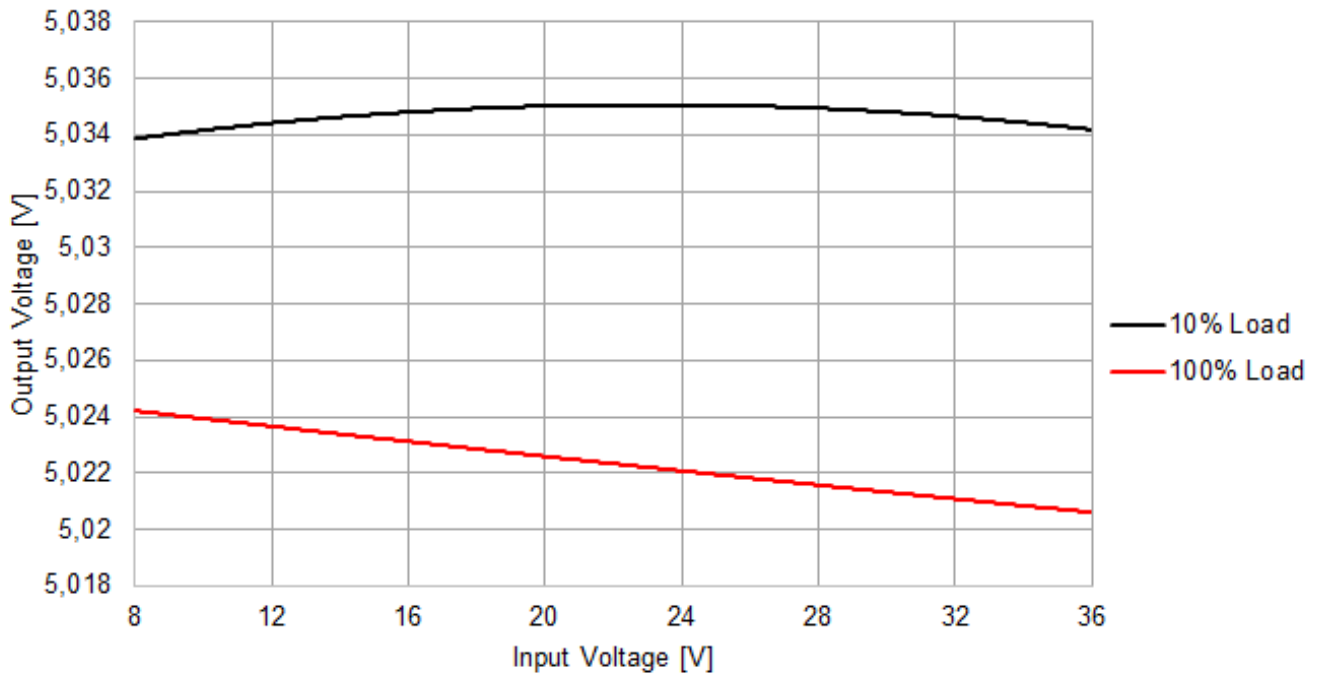

LINE REGULATION - 173010535

173010535 Line Regulation $V_{OUT} = 5V$, $T_A = 25^\circ C$ 173010535 Line Regulation $V_{OUT} = 5V$, $T_A = 85^\circ C$ 

17301xx35

MagI³C Power Module

FDSM - Fixed Step Down Regulator Module



LINE REGULATION - 173011235

173011235 Line Regulation $V_{OUT} = 12V$, $T_A = 25^\circ C$

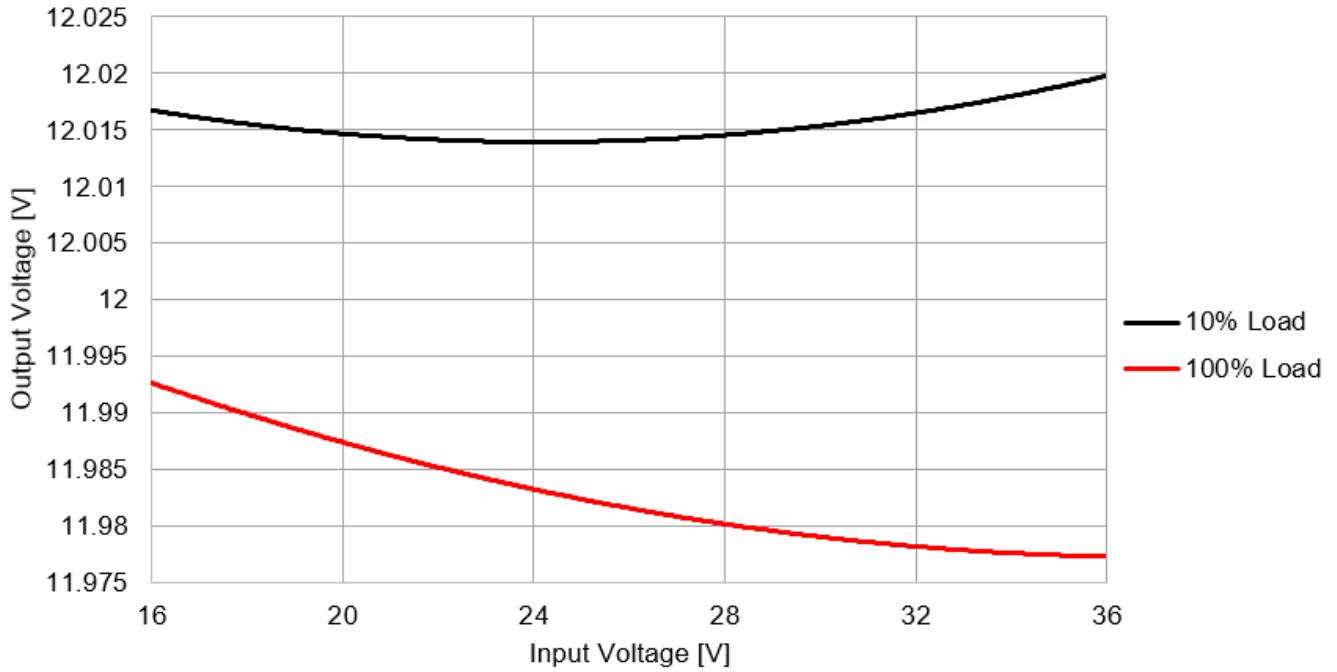

173011235 Line Regulation $V_{OUT} = 12V$, $T_A = 85^\circ C$

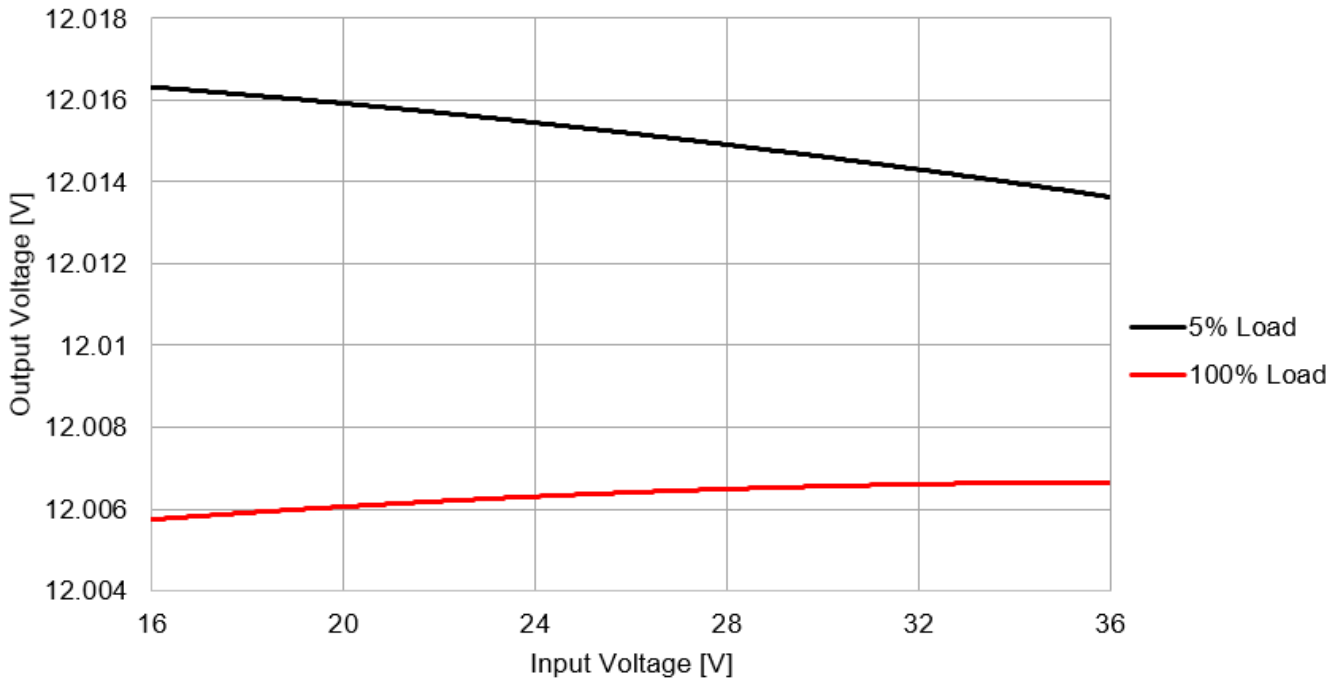

17301xx35

MagI³C Power Module

FDSM - Fixed Step Down Regulator Module



BLOCK DIAGRAM

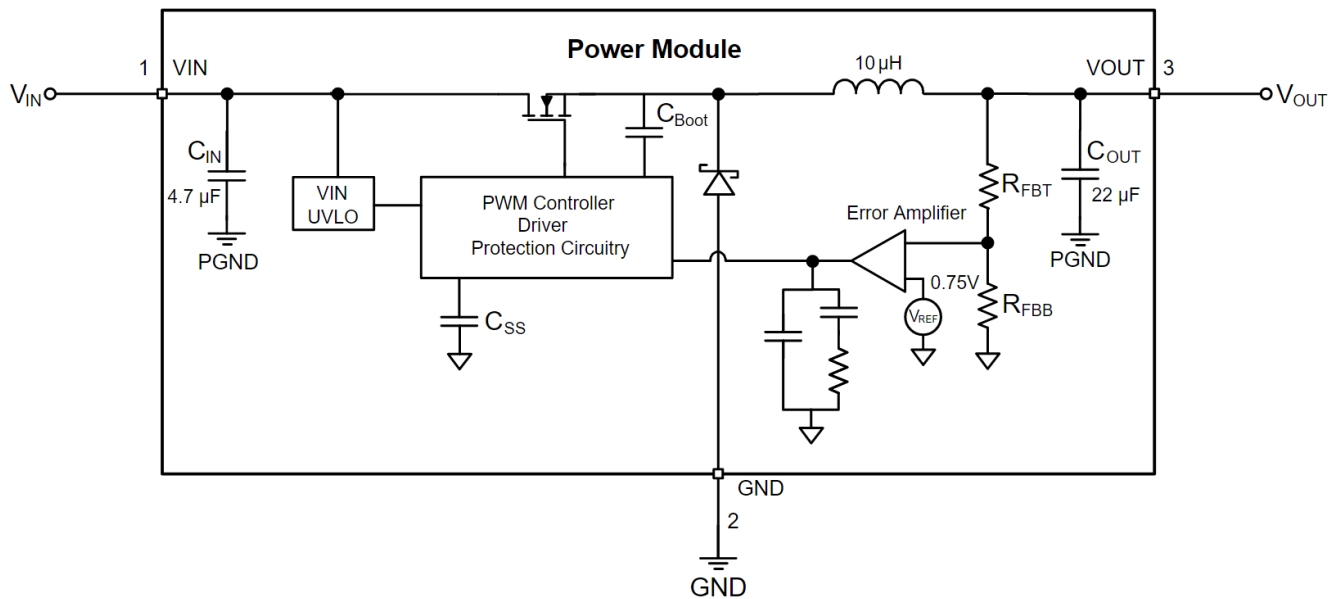

CIRCUIT DESCRIPTION

The MagI³C power modules 173010335, 173010535 and 173011235 are all based on a non-synchronous step-down regulator with integrated MOSFET, free-wheeling diode, power inductor, input and output capacitors. The control scheme is based on a current mode (CM) regulation loop.

The V_{OUT} of the regulator is divided with the internal feedback resistor network and fed into the error amplifier, which compares this signal with the internal 0.75V reference. The error amplifier controls the on-time of a fixed frequency pulse width generator, which drives the MOSFET.

The current mode architecture features a constant frequency during load steps. Only the on-time is modulated. It is internally compensated and stable with low ESR output capacitors. No external compensation network is required. This architecture supports fast transient response and very small output voltage ripple values (<20mV_{pp}) are achieved.

17301xx35

MagI³C Power Module

FDSM - Fixed Step Down Regulator Module



LIGHT LOAD OPERATION

Under light load operation, the device switches from PWM mode to PFM mode. The load current where the transition between modes takes place can be estimated using the following formula:

$$I_{OUT(DCM)} = \frac{V_{OUT} \cdot \left(1 - \frac{V_{OUT}}{V_{IN}}\right)}{2 \cdot f_{SW} \cdot L} \quad (1)$$

The following figures show the device working in PWM mode with continuous conduction operation (CCM).

17301xx35 Inductor Ripple Current $V_{IN} = 24V$ and $I_{OUT} = 1A$
CCM Operation

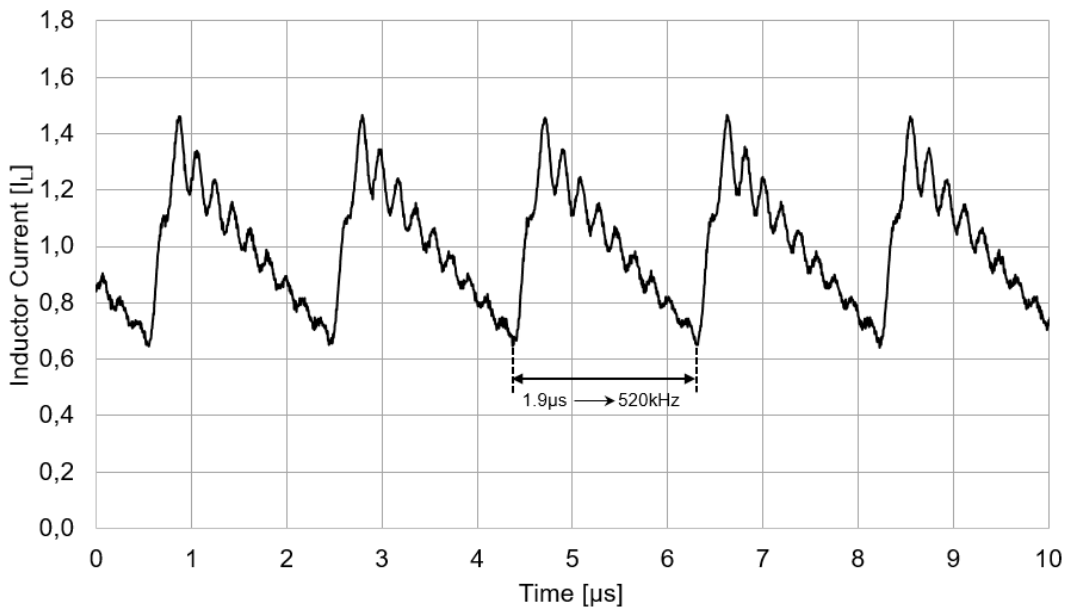

17301xx35 Inductor Ripple Current $V_{IN} = 24V$ and $I_{OUT} = 500mA$
CCM Operation

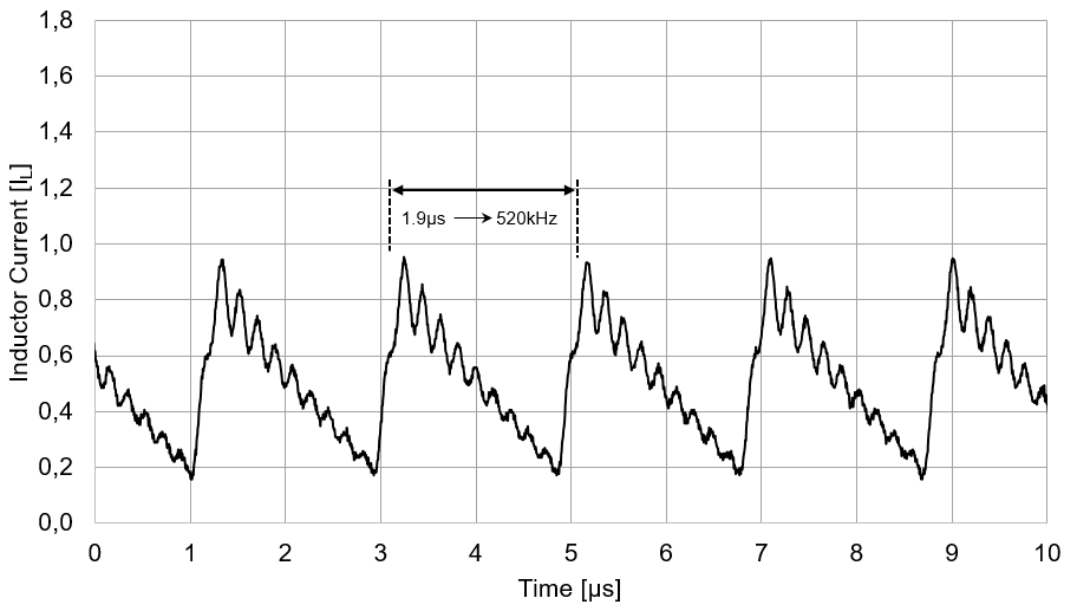

17301xx35

MagI³C Power Module

FDSM - Fixed Step Down Regulator Module



If the load current is further reduced, the device decreases the switching frequency in order to limit the energy transferred to the output (to both the output capacitor and load) maintaining regulation of the output voltage. The frequency reduction is shown in the figure below during PFM mode, with discontinuous operation (DCM).

17301xx35 Inductor Ripple Current $V_{IN} = 24V$ and $I_{OUT} = 200mA$
DCM Operation

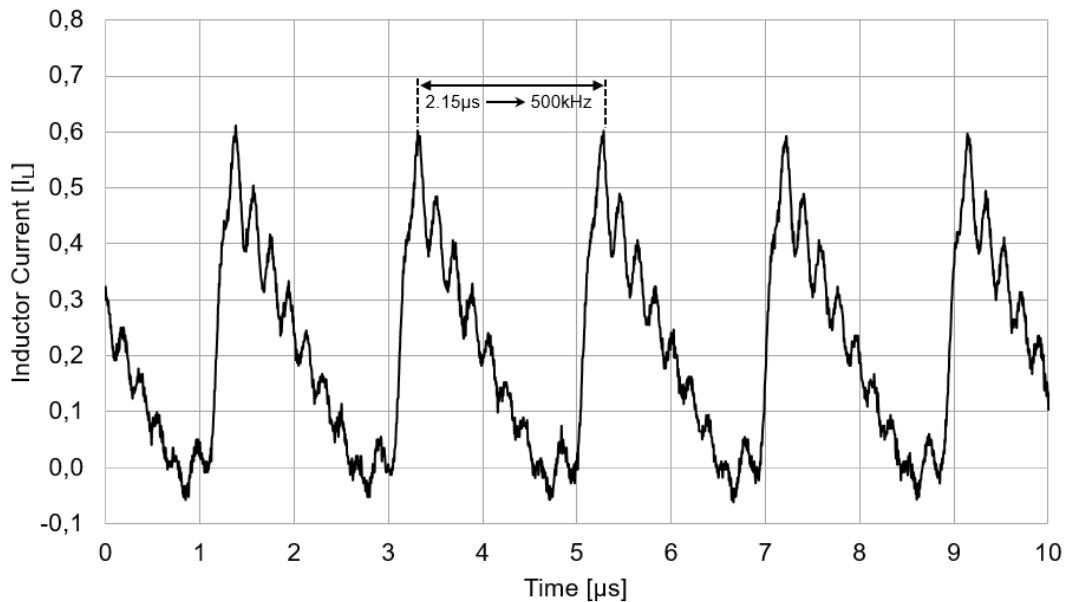

17301xx35 Inductor Ripple Current $V_{IN} = 24V$ and $I_{OUT} = 50mA$
DCM Operation

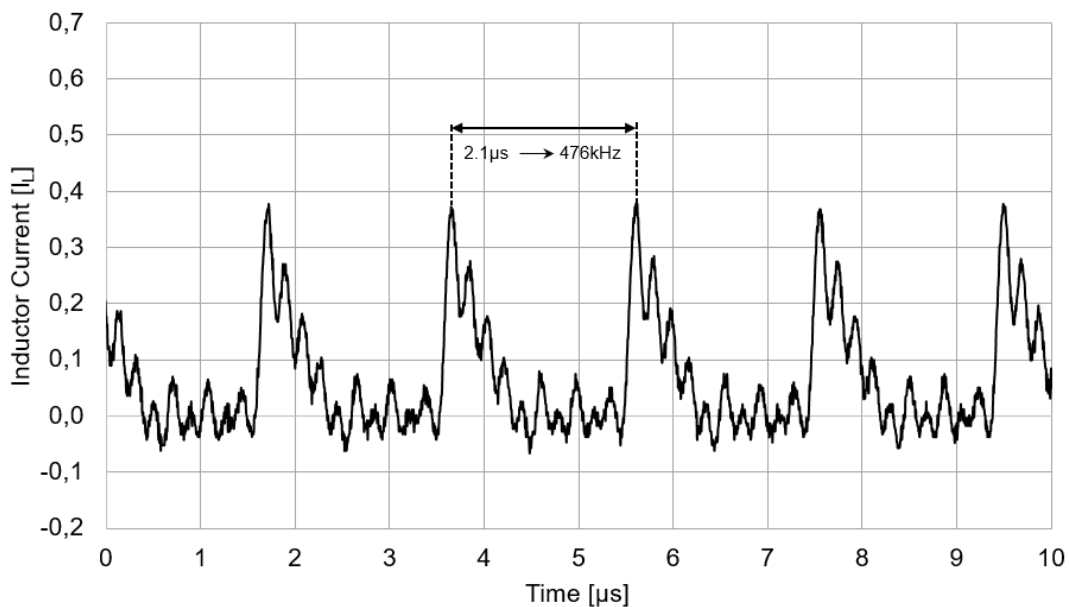

17301xx35

MagI³C Power Module

FDSM - Fixed Step Down Regulator Module



OUTPUT VOLTAGE RIPPLE

The output voltage ripple depends on several parameters. The figure below shows the V_{OUT} ripple at full load using a $22\mu\text{F}$ MLCC output capacitor. An output voltage ripple of less than 20mV_{pp} is measured under the conditions indicated.

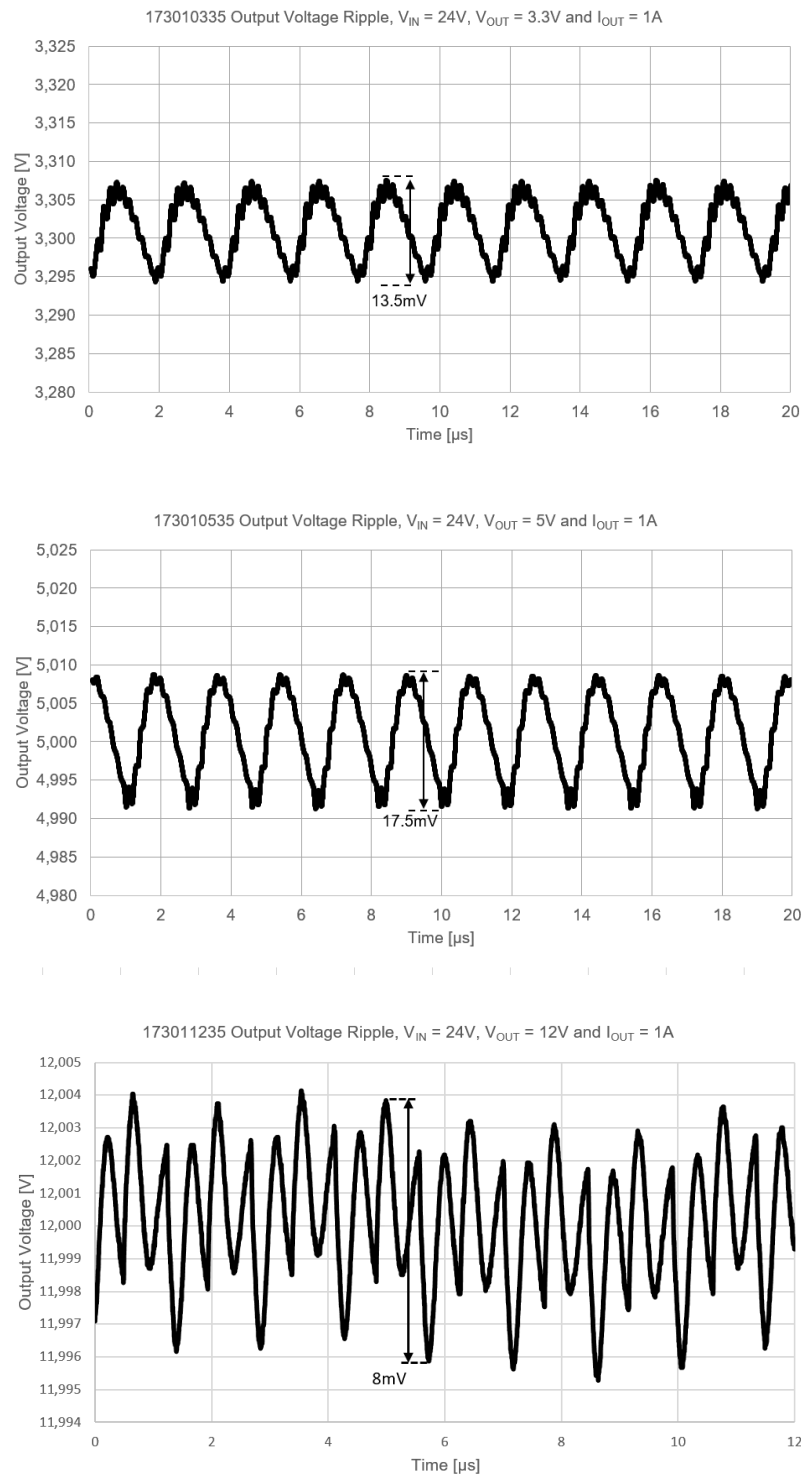

17301xx35

MagI³C Power Module

FDSM - Fixed Step Down Regulator Module



PROTECTION FEATURES

Soft-Start

In order to prevent the output voltage from overshooting during start-up, a soft-start is internally set. The figures below show the start-up behavior of the power module with the 3.3V, 5V and 12V output voltage, respectively.

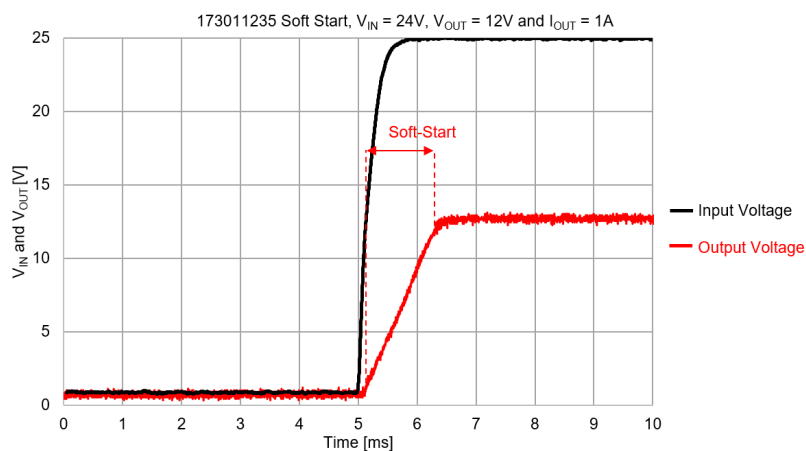
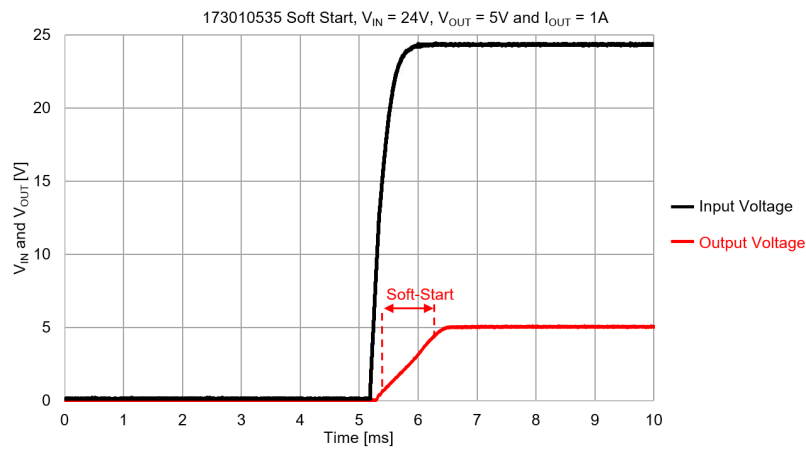
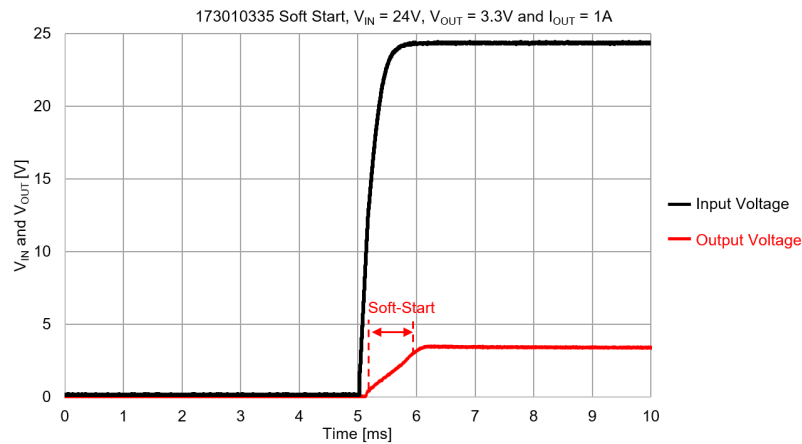

17301xx35

MagI³C Power Module

FDSM - Fixed Step Down Regulator Module



Over Temperature Protection (OTP)

Thermal protection helps to prevent catastrophic failures due to accidental device overheating. The junction temperature of the MagI³C power module should not be allowed to exceed its maximum ratings. Thermal protection is implemented by an internal thermal shutdown circuit which activates at 170 °C (typ.), causing the device to enter a low power standby state. In this state, the MOSFET remains off, causing V_{OUT} to fall. When the junction temperature falls back below 158 °C (typ.) (hysteresis is implemented) V_{OUT} rises smoothly and normal operation resumes.

Short Circuit Protection (SCP)

The short circuit protection is realized via cycle by cycle current monitoring and a frequency foldback scheme where the off time of the high side switch increases relative to a decrease of the feedback voltage. For example, the power module switching frequency is divided by 2, 4 and 8 as the feedback voltage decreases to 75%, 50% and 25%, respectively. Recovery from short circuit protection mode occurs during the switching cycle following the removal of the short circuit condition. When the power module recovers from a short circuit condition, the soft-start will not activate. Therefore, an overshoot at the output voltage can be observed (see figure below). Under short circuit conditions, the input current is limited.

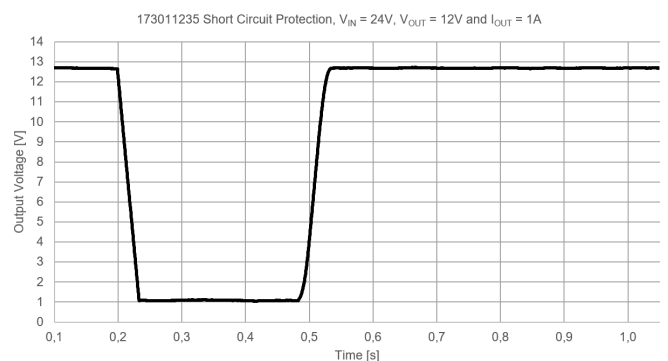
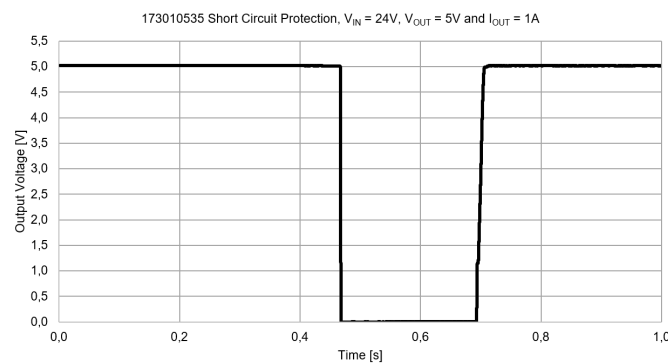
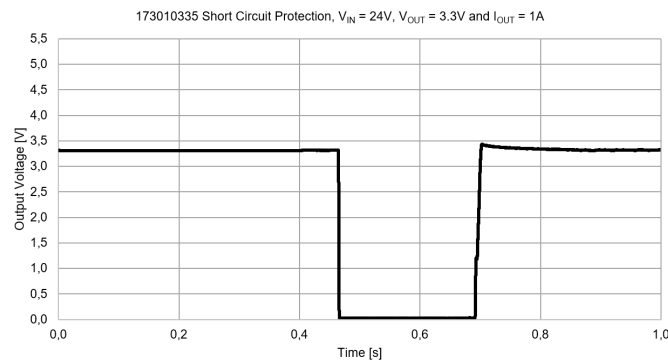

17301xx35

Magl³C Power Module

FDSM - Fixed Step Down Regulator Module



Over Current Protection (OCP)

For protection against load faults, the power module incorporates cycle by cycle current monitoring. During an overcurrent condition the output current is limited and the output voltage drops. When the overcurrent condition is removed, the output voltage returns to the nominal voltage.

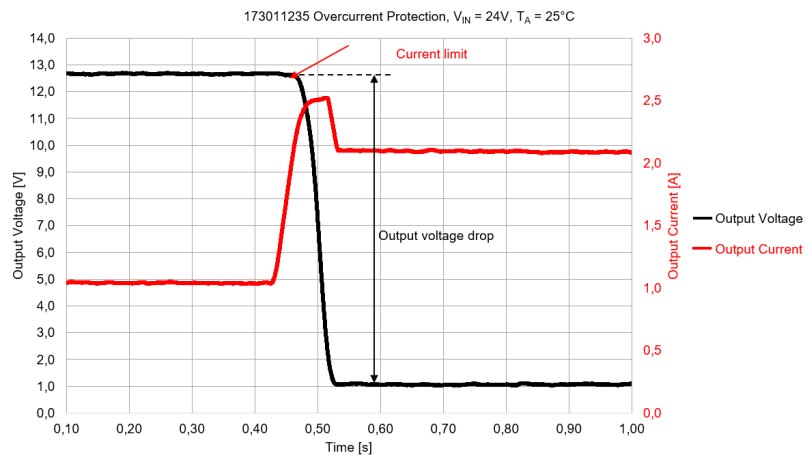
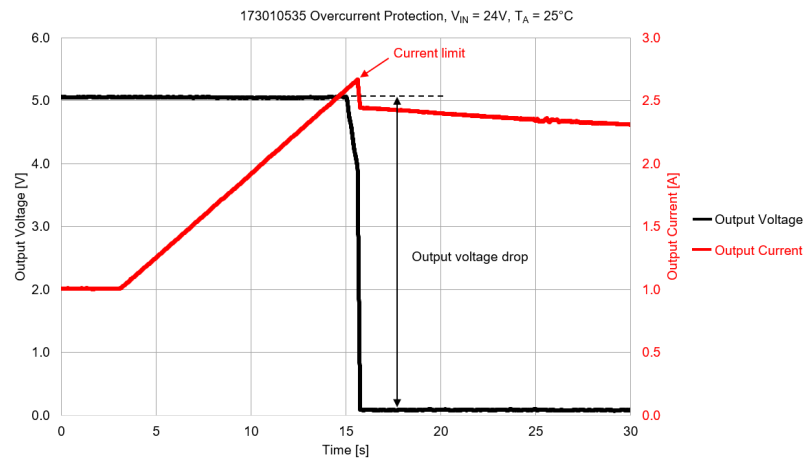
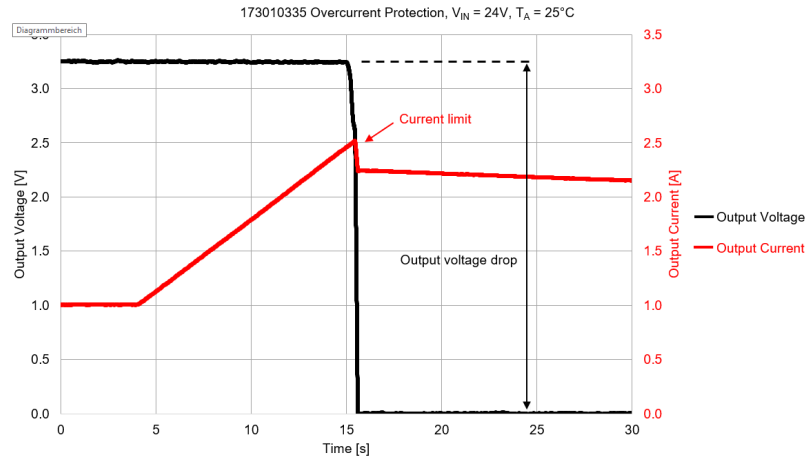

17301xx35**MagI³C** Power Module**FDSM** - Fixed Step Down Regulator Module

LAYOUT RECOMMENDATION

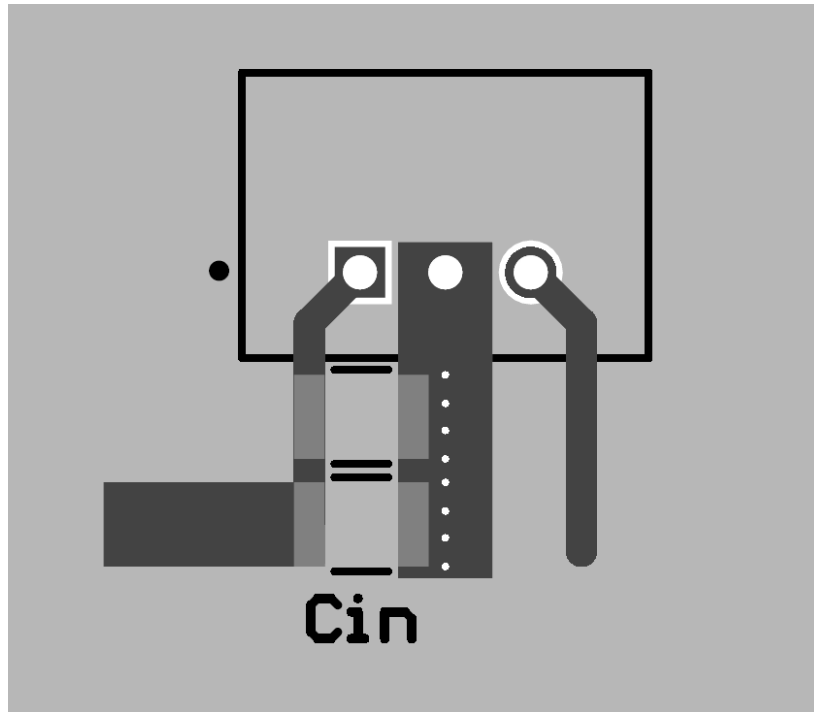

The picture above shows a possible layout for the 17301xx35 family. Nevertheless, the following recommendation should be followed when designing the layout:

1. The input capacitor should be placed as close as possible to the VIN pin of the device.

17301xx35

MagI³C Power Module

FDSM - Fixed Step Down Regulator Module

Evaluation Board Schematic

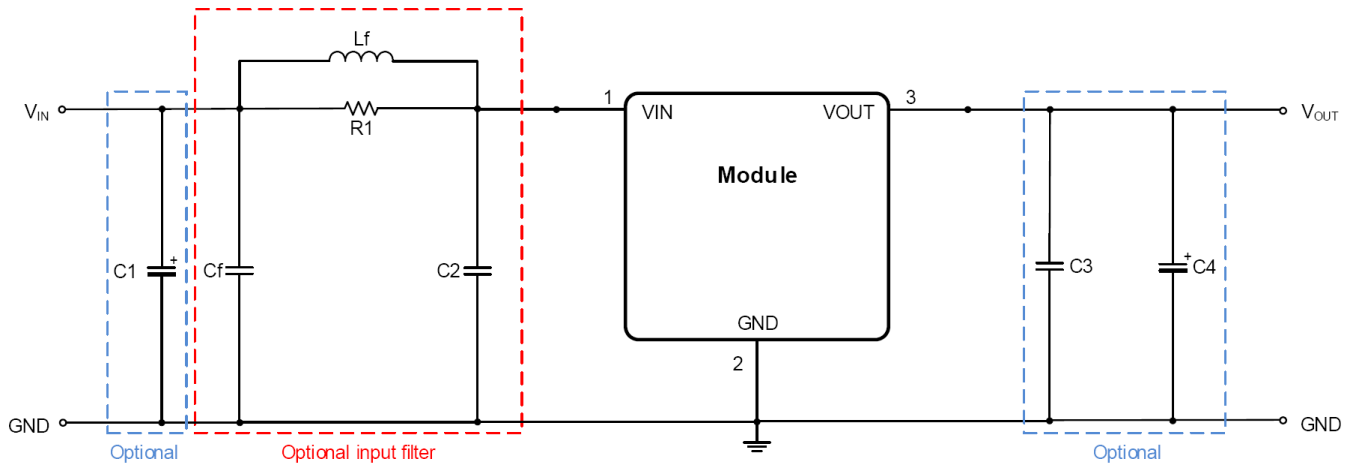

The 17301xx35 family integrates both the input and output capacitors. It is also recommended to use a $10\mu\text{F}$ input capacitor, C2, for high impedance input wires or traces and a $22\mu\text{F}$ output capacitor, C3, for applications where a low output voltage ripple is required.

The additional $100\mu\text{F}$ aluminum electrolytic capacitor, C1, is mounted at the termination of the supply line and provides a slight damping of possible oscillations of the series resonance circuit represented by the inductance of the supply line and the input capacitance.

The additional MLCC, C_f , is part of the input filter and is not mounted on the board. The inductor, L_f , is not mounted too (see recommended part number in the table below). A zero ohm resistor, R_1 , is mounted in parallel with L_f . In case the input filter is placed, R_1 must be removed and an appropriate L_f mounted.

In case particular application requirements are demanding additional capacitance, the evaluation board gives the possibility to place additional capacitance at the output: C_4 (surface mounted electrolytic). This capacitor allows for the fine tuning of the load transient response of the output voltage.

Bill of Materials

Symbol	Description	Quantity	Order Code	Manufacturer
U1	MagI ³ C Power Module (not mounted)	1	17301xx35	Würth Elektronik
C ₁	Aluminum electrolytic capacitor, ATG5 family, $100\mu\text{F}/50\text{V}$	1	860010674014	Würth Elektronik
C ₂	Al-Poly capacitor $10\mu\text{F}/63\text{V}$ (not mounted)	1	875115852001	Würth Elektronik
C ₃	Ceramic chip capacitor $10\mu\text{F}/16\text{V}$ X5R, 0805 (173010335, 173010535)	1	885012107014	Würth Elektronik
C ₄	Ceramic chip capacitor $10\mu\text{F}/10\text{V}$ X5R, 0805 (173011235)	1	885012005009	Würth Elektronik
C _f	Ceramic chip capacitor $4.7\mu\text{F}/16\text{V}$ X5R, 0805	1	885012107018	Würth Elektronik
L _f	Ceramic chip capacitor $10\mu\text{F}/16\text{V}$ X5R, 0805	1	885012107014	Würth Elektronik
R ₁	SMD bridge 0	1		

17301xx35

MagI³C Power Module

FDSM - Fixed Step Down Regulator Module



Filter Suggestion for Conducted EMI

The input filter shown in the schematic below is recommended to achieve conducted compliance according to EN55032 and CISPR32 Class B norms (see results on page 7). For radiated EMI, the filter is not necessary. It is only used to comply with the setup recommended in the norms.

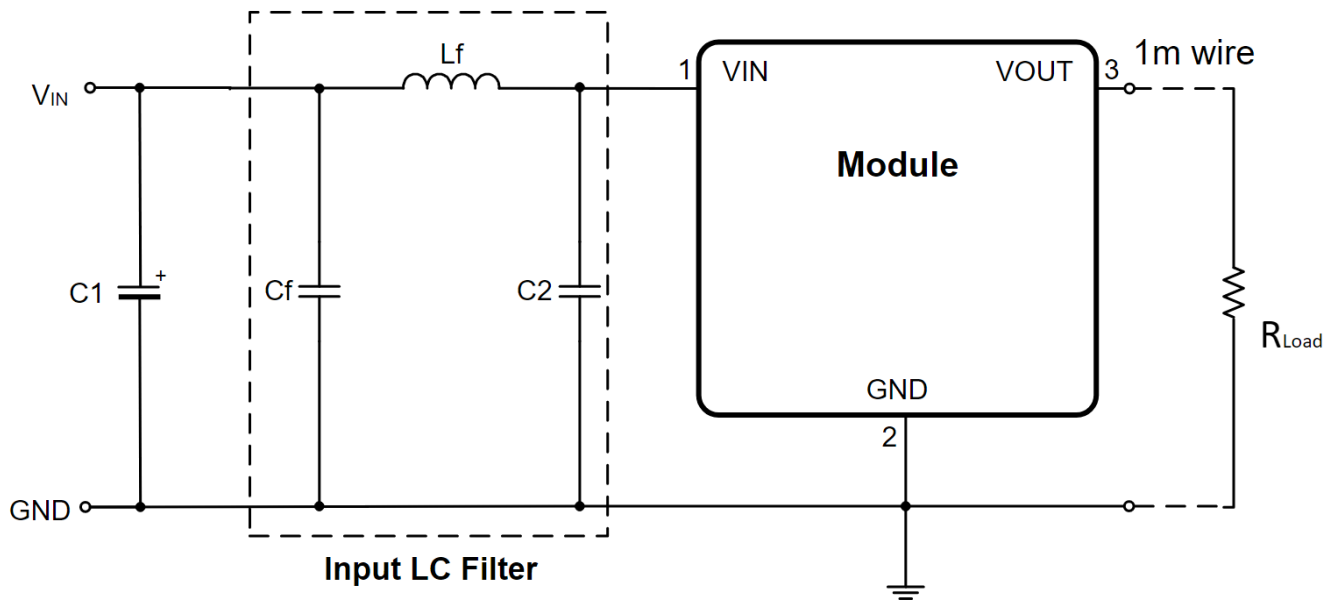

Bill of Materials of the Input LC Filter (V_{IN} = 24V, V_{OUT} = 3.3V, 5V and 12V, I_{OUT} = 1A)

Symbol	Description	Order Code	Manufacturer
C ₂	Al-Poly capacitor 10 μ F/63V	875115852001	Würth Elektronik
C _f	Filter Al-Poly capacitor 10 μ F/63V	875115852001	Würth Elektronik
L _f	Filter inductor, 1 μ H, PD2 family, I _{SAT} = 5.72A, I _R = 4A (for 171010335 and 171010535)	7447730	Würth Elektronik
L _f	Filter inductor, 1 μ H, PD2 family, I _{SAT} = 5.72A, I _R = 4A (for 171011235)	744773047	Würth Elektronik

17301xx35**MagI³C** Power Module**FDSM** - Fixed Step Down Regulator Module**Generating Negative Output Voltage**

Many industrial applications require negative voltages. The 17301xx35 family can easily provide a negative voltage using the circuit shown below. The module VOUT pin is attached to the application ground and the module GND pin is used to provide the output voltage. For low output voltage ripple, it is recommended to use an additional 22µF external capacitor at the output of the module.

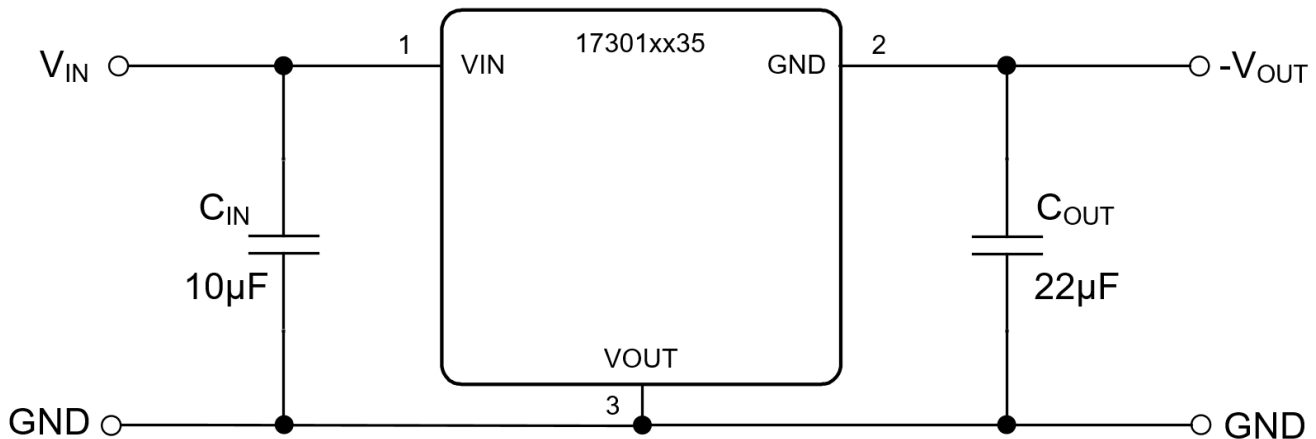

It is important to be aware that in this configuration the power module must withstand the sum of the input voltage and the absolute value of the output voltage ($V_{IN} + |V_{OUT}|$), instead of just the input voltage. This means that the maximum operating voltage should be limited to $36V - |V_{OUT}|$ (e.g. if the 173010535 is used in this configuration, the input voltage should not exceed 31V). Moreover, the maximum output current of this configuration is no longer 1A; instead it must be reduced according to the following formula (this is also illustrated in the graph below):

$$I_{OUT(DCM)} = \frac{V_{OUT} \cdot \left(1 - \frac{V_{OUT}}{V_{IN}}\right)}{2 \cdot f_{SW} * L} \quad (2)$$

where D is the duty cycle, in this case defined according to:

$$I_{OUT(DCM)} = \frac{V_{OUT} \cdot \left(1 - \frac{V_{OUT}}{V_{IN}}\right)}{2 \cdot f_{SW} * L} \quad (3)$$

For additional information, please refer to the Application Note [ANS007b](#).

Starting Conditions for Generating Negative Output Voltage:

$V_{IN_MIN} = 6V$ (173010335), $V_{IN_MIN} = 8V$ (173010535) and $V_{IN_MIN} = 8V$ (173011235)

17301xx35

MagI³C Power Module

FDSM - Fixed Step Down Regulator Module

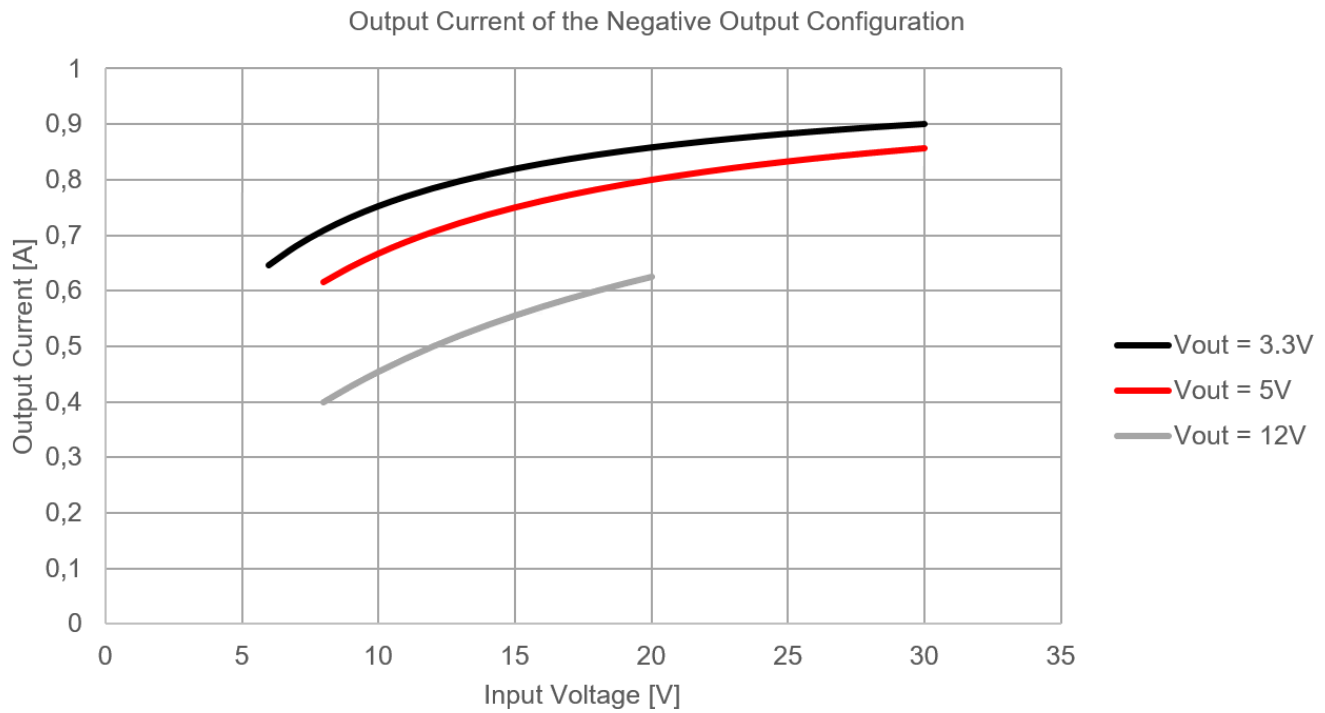

Compared with a standard positive buck configuration, the negative output buck contains an additional critical loop (between V_{IN} and V_{OUT}), which needs an additional capacitor C_{IN} , as shown in the circuit above.

17301xx35

MagI³C Power Module

FDSM - Fixed Step Down Regulator Module



Generating Complementary Output Voltage

Another common requirement in industrial applications is to provide a complementary voltage (e.g. $\pm 5V$). The circuit below shows how this target can be achieved simply combining one of the 17301xx35 family used in a standard configuration (delivering a positive output voltage) with the above mentioned solution for negative voltages. For low output voltage ripple, it is recommended to use an additional $22\mu F$ external capacitor at the output of the module.

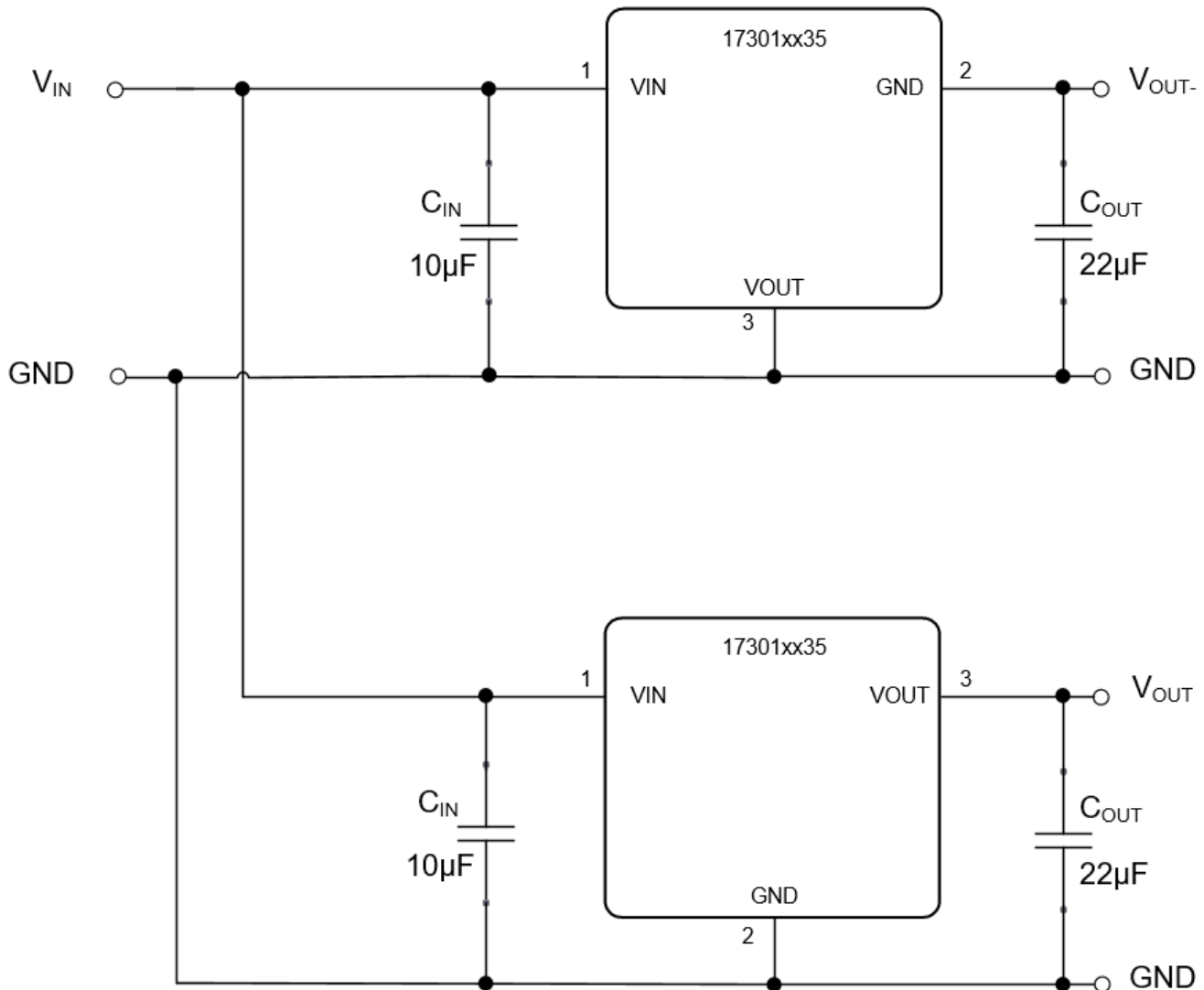

Complementary Output Voltage

17301xx35

MagI³C Power Module

FDSM - Fixed Step Down Regulator Module



WAVE SOLDER PROFILE

Profile Feature	Old standard (Pb)	New (Pb-free)
Time within peak temperature t_p	10s	10s
Average ramp-up rate	200 °C/s	200 °C/s
Final preheat temperature T_s	130 °C/s	130 °C/s
Peak temperature T_p	+235 °C/s	+260 °C/s
Ramp-down rate	-5 °C/s	-5 °C/s
Heating rate during preheat	4 °C/s	4 °C/s

Wave Solder Diagram:

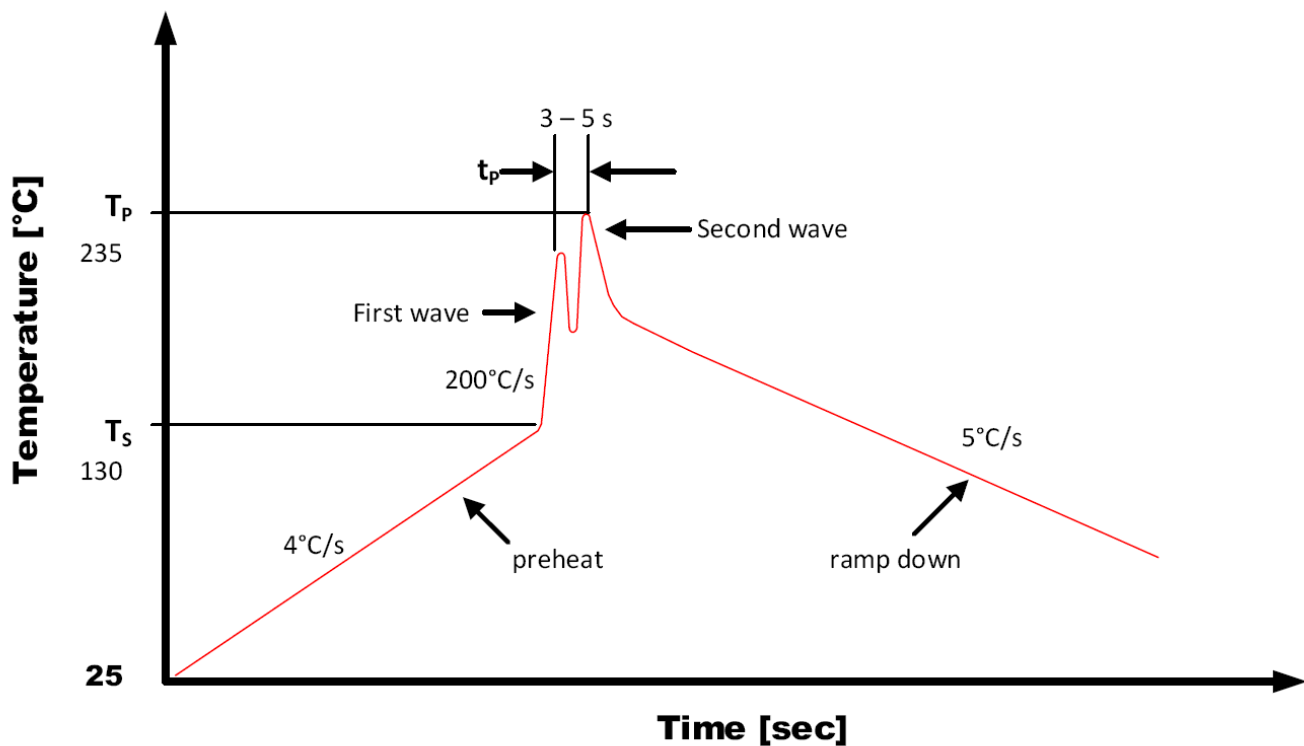

17301xx35

MagI³C Power Module

FDSM - Fixed Step Down Regulator Module



PHYSICAL DIMENSIONS

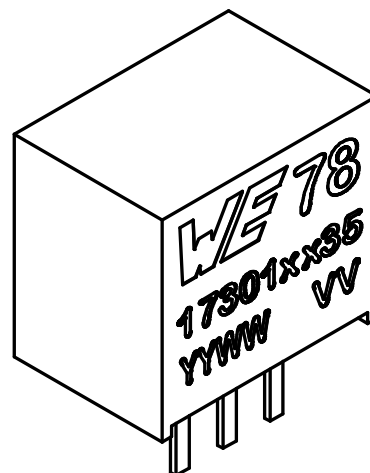
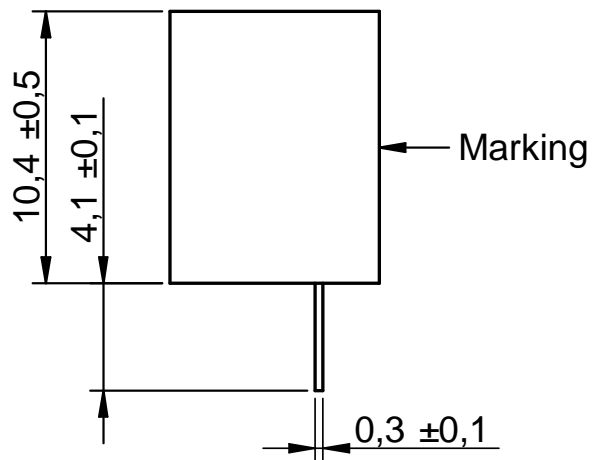
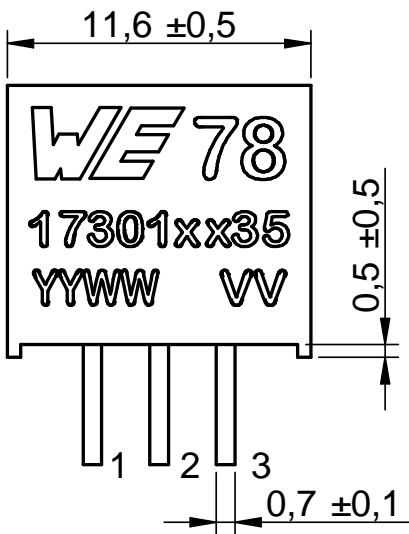
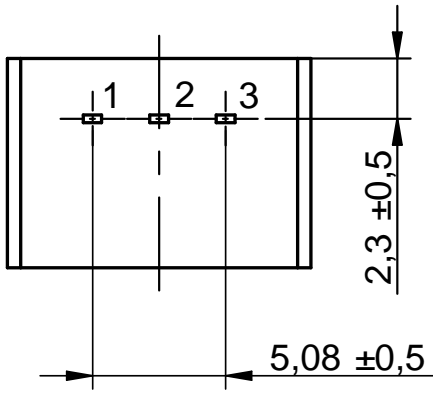

17301xx35

MagI³C Power Module

FDSM - Fixed Step Down Regulator Module



RECOMMENDED DRILL HOLES

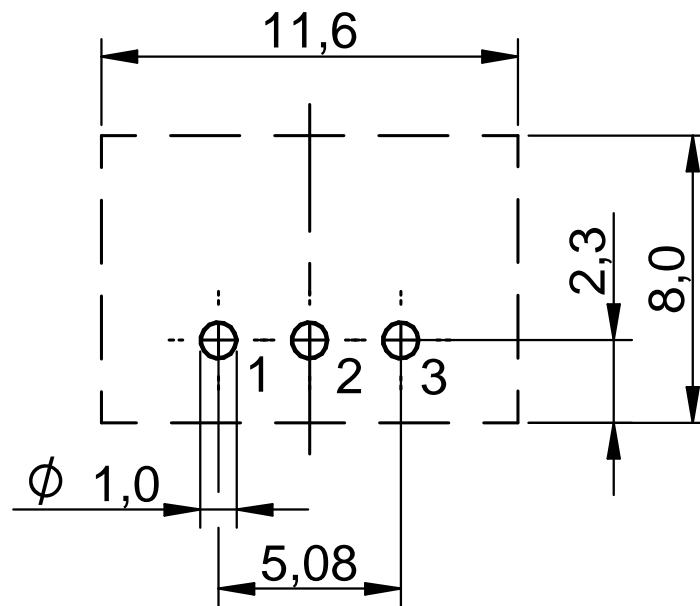

17301xx35**MagI³C** Power Module**FDSM** - Fixed Step Down Regulator Module**DOCUMENT HISTORY**

Revision	Date	Description	Comment
1.0	November 2020	Initial data sheet release	
2.0	April 2021	Added 173011235 family member	

17301xx35

MagI³C Power Module

FDSM - Fixed Step Down Regulator Module



CAUTIONS AND WARNINGS

The following conditions apply to all goods within the product series of MagI³C of Würth Elektronik eiSos GmbH & Co. KG:

General:

- All recommendations according to the general technical specifications of the data-sheet have to be complied with.
- The usage and operation of the product within ambient conditions which probably alloy or harm the component surface has to be avoided.
- Electronic components that will be used in safety-critical or high-reliability applications, should be pre-evaluated by the customer.
- The component is designed and manufactured to be used within the datasheet specified values. If the usage and operation conditions specified in the datasheet are not met, the component may be damaged or dissolved.
- Do not drop or impact the components as material of the body, pins or termination may flake apart.
- Würth Elektronik eiSos products are qualified according to international standards, which are listed in each product reliability report. Würth Elektronik eiSos does not warrant any customer qualified product characteristics beyond Würth Elektronik eiSos's specifications, for its validity and sustainability over time.
- The responsibility for the applicability of the customer specific products and use in a particular customer design is always within the authority of the customer. All technical specifications for standard products also apply to customer specific products.
- Customer acknowledges and agrees that it is solely responsible for compliance with all legal, regulatory and safety-related requirements concerning its products, and any use of Würth Elektronik eiSos GmbH & Co. KG components in its applications, notwithstanding any applications-related information or support that may be provided by Würth Elektronik eiSos GmbH & Co. KG. Customer represents and agrees that it has all the necessary expertise to create and implement safeguards which anticipate dangerous consequences of failures, monitor failures and their consequences lessen the likelihood of failures that might cause harm and take appropriate remedial actions. Customer will fully indemnify Würth Elektronik eiSos and its representatives against any damages arising out of the use of any Würth Elektronik eiSos GmbH & Co. KG components in safety-critical applications.

Product specific:

It has to be clearly pointed out that the possibility of a malfunction of electronic components or failure before the end of the usual lifetime cannot be completely eliminated in the current state of the art, even if the products are operated within the range of the specifications. The same statement is valid for all software sourcecode and firmware parts contained in or used with or for products in the wireless connectivity and sensor product range of Würth Elektronik eiSos GmbH & Co. KG. In certain customer applications requiring a high level of safety and especially in customer applications in which the malfunction or failure of an electronic component could endanger human life or health, it must be ensured by most advanced technological aid of suitable design of the customer application that no injury or damage is caused to third parties in the event of malfunction or failure of an electronic component.

DISCLAIMER

This electronic component has been designed and developed for usage in general electronic equipment only. This product is not authorized for use in equipment where a higher safety standard and reliability standard is especially required or where a failure of the product is reasonably expected to cause severe personal injury or death, unless the parties have executed an agreement specifically governing such use. Moreover Würth Elektronik eiSos GmbH & Co. KG products are neither designed nor intended for use in areas such as military, aerospace, aviation, nuclear control, submarine, transportation (automotive control, train control, ship control), transportation signal, disaster prevention, medical, public information network etc. Würth Elektronik eiSos GmbH & Co. KG must be informed about the intent of such usage before the design-in stage. In addition, sufficient reliability evaluation checks for safety must be performed on every electronic component which is used in electrical circuits that require high safety and reliability functions or performance.

These cautions and warnings comply with the state of the scientific and technical knowledge and are believed to be accurate and reliable. However, no responsibility is assumed for inaccuracies or incompleteness.

17301xx35

Magl³C Power Module

FDSM - Fixed Step Down Regulator Module



B IMPORTANT NOTES

The following conditions apply to all goods within the product range of Würth Elektronik eiSos GmbH & Co. KG:

1. General Customer Responsibility

Some goods within the product range of Würth Elektronik eiSos GmbH & Co. KG contain statements regarding general suitability for certain application areas. These statements about suitability are based on our knowledge and experience of typical requirements concerning the areas, serve as general guidance and cannot be estimated as binding statements about the suitability for a customer application. The responsibility for the applicability and use in a particular customer design is always solely within the authority of the customer. Due to this fact it is up to the customer to evaluate, where appropriate to investigate and decide whether the device with the specific product characteristics described in the product specification is valid and suitable for the respective customer application or not. Accordingly, the customer is cautioned to verify that the datasheet is current before placing orders.

2. Customer Responsibility Related to Specific, in Particular Safety-Relevant, Applications

It has to be clearly pointed out that the possibility of a malfunction of electronic components or failure before the end of the usual lifetime cannot be completely eliminated in the current state of the art, even if the products are operated within the range of the specifications. In certain customer applications requiring a very high level of safety and especially in customer applications in which the malfunction or failure of an electronic component could endanger human life or health it must be ensured by most advanced technological aid of suitable design of the customer application that no injury or damage is caused to third parties in the event of malfunction or failure of an electronic component.

3. Best Care and Attention

Any product-specific notes, warnings and cautions must be strictly observed. Any disregard will result in the loss of warranty.

4. Customer Support for Product Specifications

Some products within the product range may contain substances which are subject to restrictions in certain jurisdictions in order to serve specific technical requirements. Necessary information is available on request. In this case the field sales engineer or the internal sales person in charge should be contacted who will be happy to support in this matter.

5. Product R&D

Due to constant product improvement product specifications may change from time to time. As a standard reporting procedure of the Product Change Notification (PCN) according to the JEDEC-Standard we inform about minor and major changes. In case of further queries regarding the PCN, the field sales engineer or the internal sales person in charge should be contacted. The basic responsibility of the customer as per Section 1 and 2 remains unaffected.

6. Product Life Cycle

Due to technical progress and economical evaluation we also reserve the right to discontinue production and delivery of products. As a standard reporting procedure of the Product Termination Notification (PTN) according to the JEDEC-Standard we will inform at an early stage about inevitable product discontinuance. According to this we cannot guarantee that all products within our product range will always be available. Therefore it needs to be verified with the field sales engineer or the internal sales person in charge about the current product availability expectancy before or when the product for application design-in disposal is considered. The approach named above does not apply in the case of individual agreements deviating from the foregoing for customer-specific products.

7. Property Rights

All the rights for contractual products produced by Würth Elektronik eiSos GmbH & Co. KG on the basis of ideas, development contracts as well as models or templates that are subject to copyright, patent or commercial protection supplied to the customer will remain with Würth Elektronik eiSos GmbH & Co. KG. Würth Elektronik eiSos GmbH & Co. KG does not warrant or represent that any license, either expressed or implied, is granted under any patent right, copyright, mask work right, or other intellectual property right relating to any combination, application, or process in which Würth Elektronik eiSos GmbH & Co. KG components or services are used.

8. General Terms and Conditions

Unless otherwise agreed in individual contracts, all orders are subject to the current version of the "General Terms and Conditions of Würth Elektronik eiSos Group", last version available at www.we-online.com.

Data Sheet version 2.0

www.we-online.com/powermodules

© April 2021

42