

- ▼ 100% R<sub>g</sub> & UIS Test
- ▼ Simple Drive Requirement
- ▼ Lower On-resistance
- ▼ RoHS Compliant & Halogen-Free

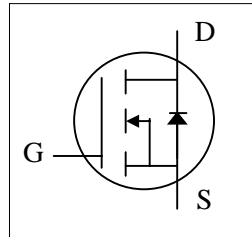

BV <sub>DSS</sub>	100V
R <sub>DS(ON)</sub>	3.5mΩ

### Description

XP10N3R5 series are innovated design and silicon process technology to achieve the lowest possible on-resistance and fast switching performance. It provides the designer with an extreme efficient device for use in a wide range of power applications.

The PMPAK<sup>®</sup> 5x6X package is special for DC-DC converters application and the foot print is compatible with SO-8 with backside heat sink and lower profile.

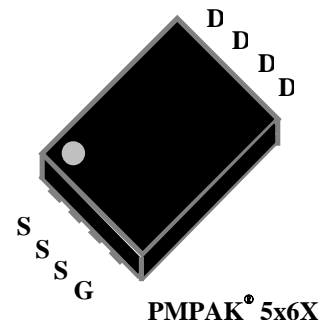

### Absolute Maximum Ratings @T<sub>j</sub>=25°C (unless otherwise specified)

Symbol	Parameter	Rating	Units
V <sub>DS</sub>	Drain-Source Voltage	100	V
V <sub>GS</sub>	Gate-Source Voltage	±20	V
I <sub>D</sub> @T <sub>C</sub> =25°C	Drain Current, V <sub>GS</sub> @ 10V <sup>5</sup> (Silicon Limited)	142	A
I <sub>D</sub> @T <sub>C</sub> =25°C	Drain Current, V <sub>GS</sub> @ 10V <sup>5</sup> (Package Limited)	100	A
I <sub>D</sub> @T <sub>C</sub> =100°C	Drain Current, V <sub>GS</sub> @ 10V	90	A
I <sub>D</sub> @T <sub>A</sub> =25°C	Drain Current, V <sub>GS</sub> @ 10V <sup>3</sup>	28.5	A
I <sub>D</sub> @T <sub>A</sub> =70°C	Drain Current, V <sub>GS</sub> @ 10V <sup>3</sup>	22.8	A
I <sub>DM</sub>	Pulsed Drain Current <sup>1</sup>	360	A
P <sub>D</sub> @T <sub>C</sub> =25°C	Total Power Dissipation	125	W
P <sub>D</sub> @T <sub>A</sub> =25°C	Total Power Dissipation <sup>3</sup>	5	W
E <sub>AS</sub>	Single Pulse Avalanche Energy <sup>4</sup>	180	mJ
T <sub>STG</sub>	Storage Temperature Range	-55 to 150	°C
T <sub>J</sub>	Operating Junction Temperature Range	-55 to 150	°C

### Thermal Data

Symbol	Parameter	Value	Unit
R <sub>thj-c</sub>	Maximum Thermal Resistance, Junction-case	1	°C/W
R <sub>thj-a</sub>	Maximum Thermal Resistance, Junction-ambient <sup>3</sup>	25	°C/W

**Electrical Characteristics @T<sub>j</sub>=25°C(unless otherwise specified)**

Symbol	Parameter	Test Conditions	Min.	Typ.	Max.	Units
BV <sub>DSS</sub>	Drain-Source Breakdown Voltage	V <sub>GS</sub> =0V, I <sub>D</sub> =250uA	100	-	-	V
R <sub>DS(ON)</sub>	Static Drain-Source On-Resistance <sup>2</sup>	V <sub>GS</sub> =10V, I <sub>D</sub> =20A	-	-	3.5	mΩ
V <sub>GS(th)</sub>	Gate Threshold Voltage	V <sub>DS</sub> =V <sub>GS</sub> , I <sub>D</sub> =250uA	2	-	4	V
g <sub>fs</sub>	Forward Transconductance	V <sub>DS</sub> =5V, I <sub>D</sub> =20A	-	62	-	S
I <sub>DSS</sub>	Drain-Source Leakage Current	V <sub>DS</sub> =80V, V <sub>GS</sub> =0V	-	-	25	uA
I <sub>GSS</sub>	Gate-Source Leakage	V <sub>GS</sub> =±20V, V <sub>DS</sub> =0V	-	-	±0.1	uA
Q <sub>g</sub>	Total Gate Charge	I <sub>D</sub> =20A	-	84	134.4	nC
Q <sub>gs</sub>	Gate-Source Charge	V <sub>DS</sub> =50V	-	20	-	nC
Q <sub>gd</sub>	Gate-Drain ("Miller") Charge	V <sub>GS</sub> =10V	-	32	-	nC
t <sub>d(on)</sub>	Turn-on Delay Time	V <sub>DS</sub> =50V	-	21	-	ns
t <sub>r</sub>	Rise Time	I <sub>D</sub> =20A	-	74	-	ns
t <sub>d(off)</sub>	Turn-off Delay Time	R <sub>G</sub> =6Ω	-	68	-	ns
t <sub>f</sub>	Fall Time	V <sub>GS</sub> =10V	-	92	-	ns
C <sub>iss</sub>	Input Capacitance	V <sub>GS</sub> =0V	-	4050	6480	pF
C <sub>oss</sub>	Output Capacitance	V <sub>DS</sub> =80V	-	630	-	pF
C <sub>rss</sub>	Reverse Transfer Capacitance	f=1.0MHz	-	20	-	pF
R <sub>g</sub>	Gate Resistance	f=1.0MHz	-	2	4	Ω

**Source-Drain Diode**

Symbol	Parameter	Test Conditions	Min.	Typ.	Max.	Units
V <sub>SD</sub>	Forward On Voltage <sup>2</sup>	I <sub>S</sub> =20A, V <sub>GS</sub> =0V	-	-	1.3	V
t <sub>rr</sub>	Reverse Recovery Time	I <sub>S</sub> =20A, V <sub>GS</sub> =0V,	-	73	-	ns
Q <sub>rr</sub>	Reverse Recovery Charge	dI/dt=100A/μs	-	135	-	nC

**Notes:**

- 1.Pulse width limited by Max. junction temperature.
- 2.Pulse test
- 3.Surface mounted on 1 in<sup>2</sup> copper pad of FR4 board, t ≤10sec; 60°C/W at steady state.
- 4.Starting T<sub>j</sub>=25°C , V<sub>DD</sub>=50V , L=0.1mH , R<sub>G</sub>=25Ω
- 5.Package limitation current is 100A .

THIS PRODUCT IS SENSITIVE TO ELECTROSTATIC DISCHARGE, PLEASE HANDLE WITH CAUTION.

USE OF THIS PRODUCT AS A CRITICAL COMPONENT IN LIFE SUPPORT, AUTOMOTIVE OR OTHER SIMILAR SYSTEMS IS NOT AUTHORIZED.

XSEMI DOES NOT ASSUME ANY LIABILITY ARISING OUT OF THE APPLICATION OR USE OF ANY PRODUCT OR CIRCUIT DESCRIBED HEREIN; NEITHER DOES IT CONVEY ANY LICENSE UNDER ITS PATENT RIGHTS, NOR THE RIGHTS OF OTHERS.

XSEMI RESERVES THE RIGHT TO MAKE CHANGES WITHOUT FURTHER NOTICE TO ANY PRODUCTS HEREIN TO IMPROVE RELIABILITY, FUNCTION OR DESIGN.

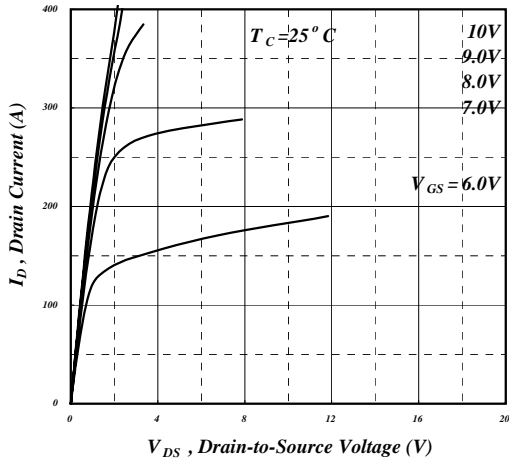

**Fig 1. Typical Output Characteristics**

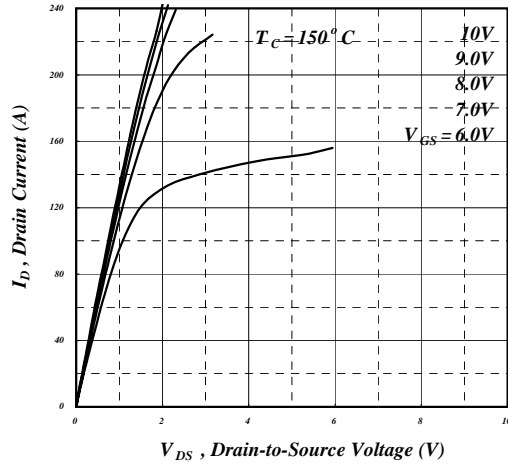

**Fig 2. Typical Output Characteristics**

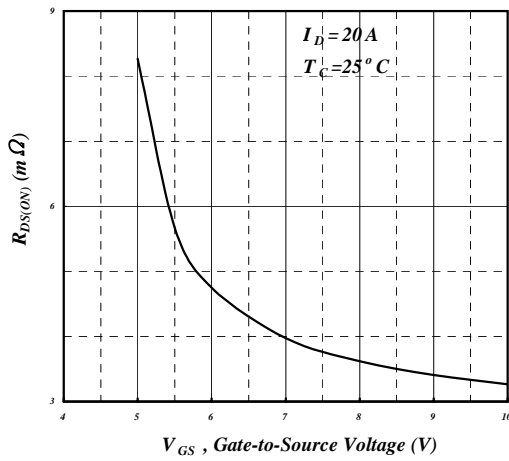

**Fig 3. On-Resistance v.s. Gate Voltage**

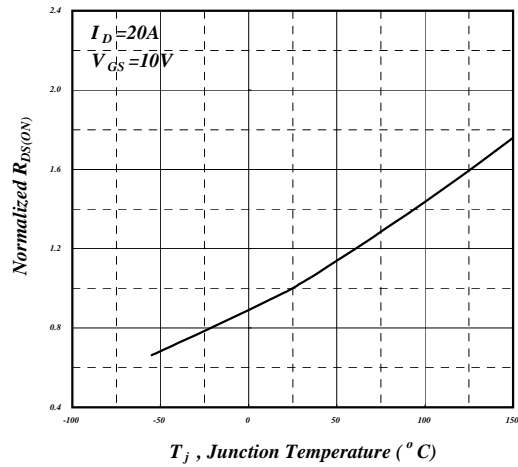

**Fig 4. Normalized On-Resistance v.s. Junction Temperature**

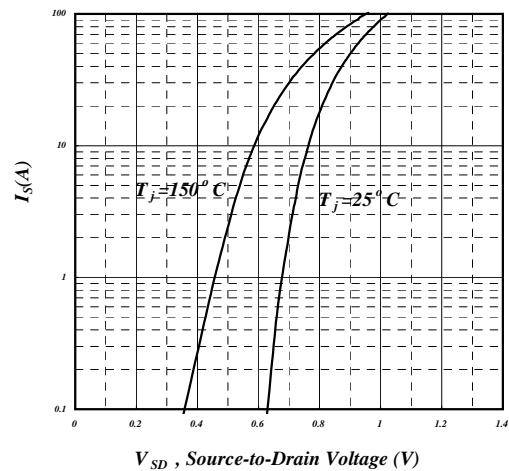

**Fig 5. Forward Characteristic of Reverse Diode**

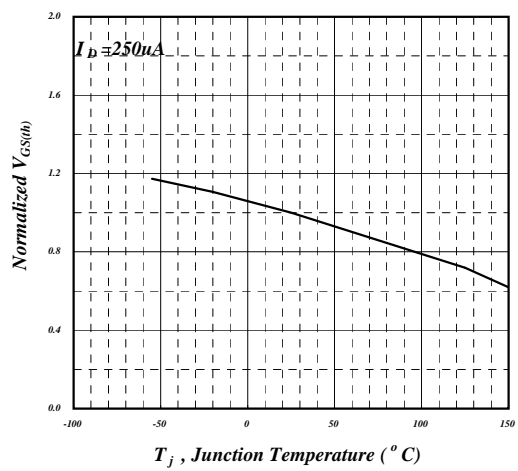

**Fig 6. Gate Threshold Voltage v.s. Junction Temperature**

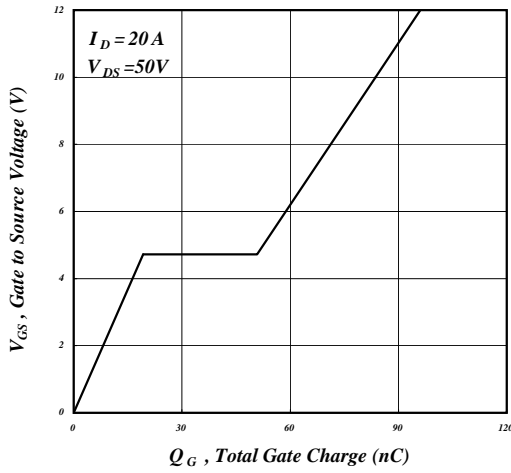

**Fig 7. Gate Charge Characteristics**

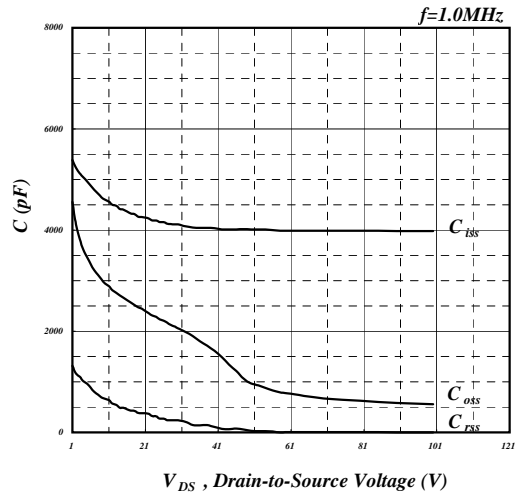

**Fig 8. Typical Capacitance Characteristics**

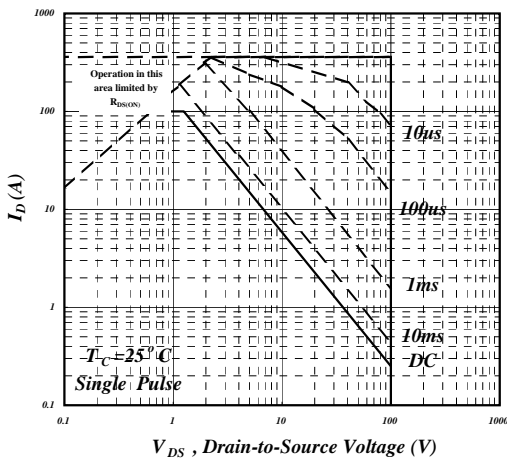

**Fig 9. Maximum Safe Operating Area**

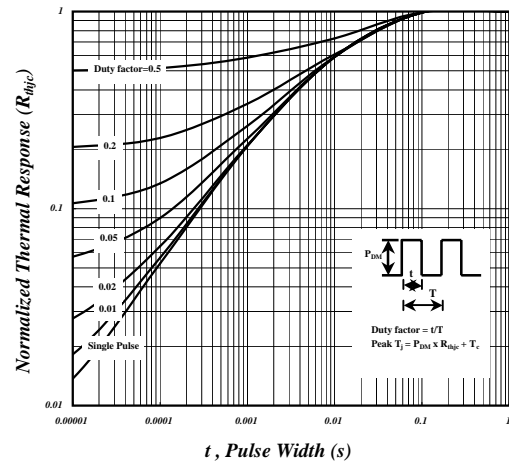

**Fig 10. Effective Transient Thermal Impedance**

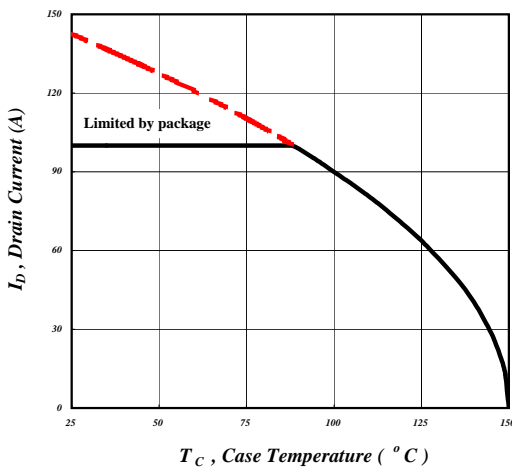

**Fig 11. Drain Current v.s. Case Temperature**

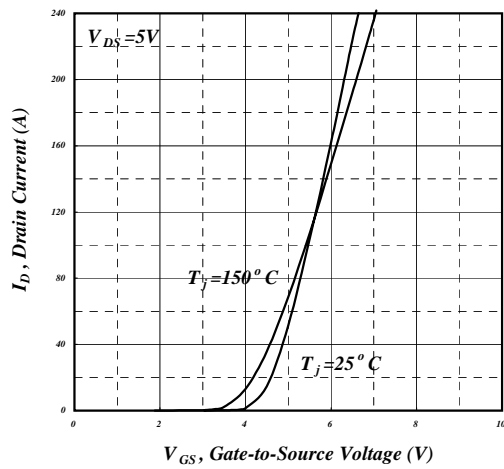

**Fig 12. Transfer Characteristics**

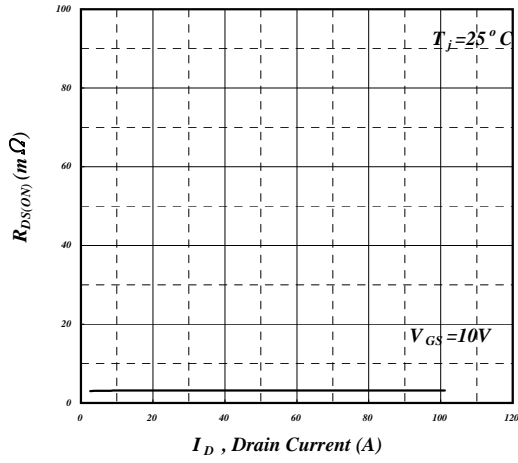

**Fig 13. Typ. Drain-Source on State Resistance**

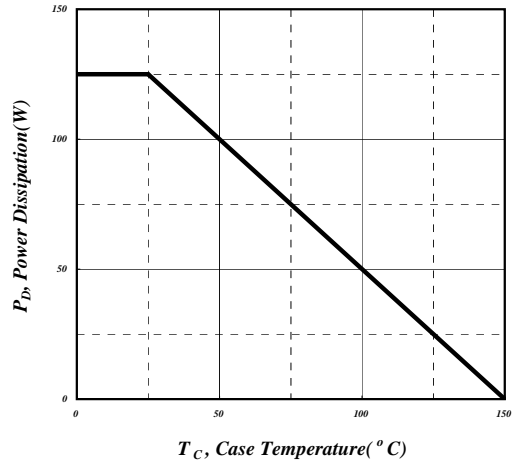

**Fig 14. Total Power Dissipation**

---

**MARKING INFORMATION**

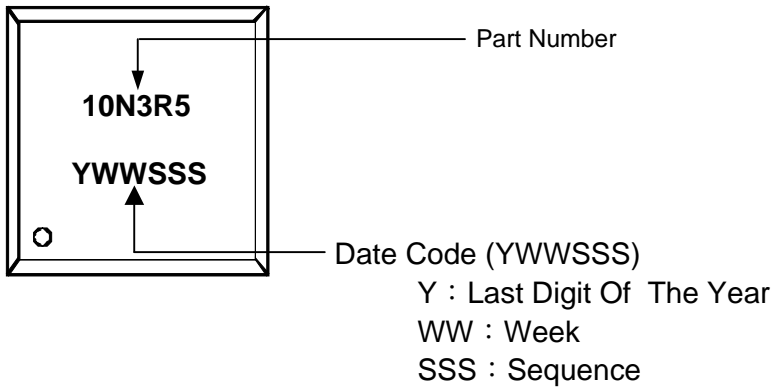

**Package Outline : PMPAK 5x6X**

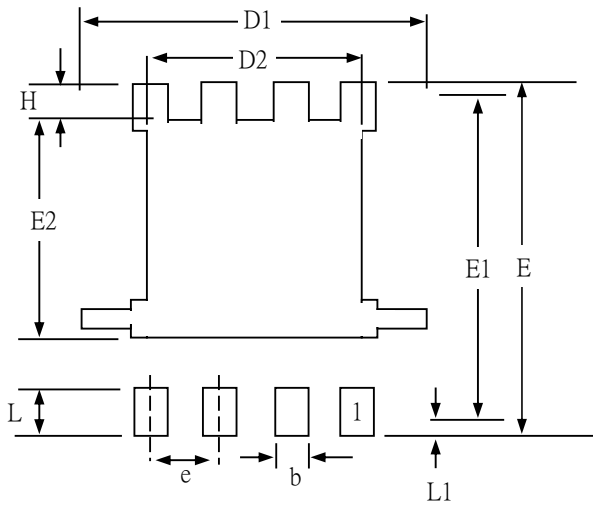

BACKSIDE VIEW

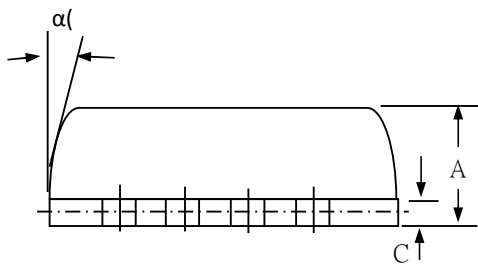

SYMBOLS	Millimeters		
	MIN	NOM	MAX
A	0.95	1.10	1.20
b	0.30	0.40	0.51
C	0.15	0.25	0.35
D1	4.90	5.20	5.40
D2	3.70	4.10	4.25
E	5.95	6.15	6.35
E1 (Ref.)	5.66	5.86	6.10
E2 (Ref.)	3.52	3.72	3.92
e	1.27BSC		
H	0.40	0.50	0.71
L	0.30	0.60	0.71
L1	0.03	-	0.22
$\alpha$ (Ref.)	0 °	-	12 °

- 1.All dimension are in millimeters.
- 2.Dimension does not include burrs and mold flash/protrusions.
- 3.The outline schematic is not to scale and slightly different from the actual product appearance.

**PMPAK 5x6X FOOTPRINT :**

