

PLEASE CHECK WWW.MOLEX.COM FOR LATEST PART INFORMATION

Part Number: [1051330001](#)
Status: **Active**
Overview: [Consumer USB Products](#)
Description: Micro-USB B Receptacle 2.30mm, Vertical, Surface Mount, Lead-Free

Documents:

3D Model	Product Specification TS-105133-001-001 (PDF)
Drawing (PDF)	Packaging Specification PK-105133-001 (PDF)
Product Specification PS-105133-001-001 (PDF)	RoHS Certificate of Compliance (PDF)
Product Specification PS-47642-001-001 (PDF)	

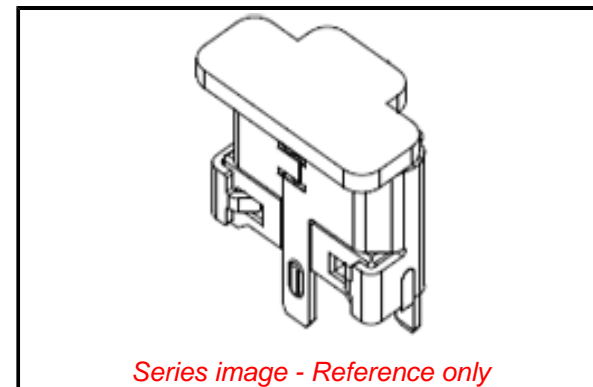

Agency Certification

UL E107635

General

Product Family	I/O Connectors
Series	105133
Application	Wire-to-Board
Comments	Signal contacts 1.0A, Power contacts 1.8A
Component Type	Receptacle
Overview	Consumer USB Products
Product Name	USB 2.0
Type	Micro-B
UPC	884982164949

Physical

Boot Color	N/A
Circuits (Loaded)	5
Circuits (maximum)	5
Color - Resin	Black
Durability (mating cycles max)	10000
Flammability	94V-0
Gender	Receptacle
Keying to Mating Part	Yes
Lock to Mating Part	No
Material - Metal	Copper Alloy
Material - Plating Mating	Gold
Material - Plating Termination	Gold
Material - Resin	High Temperature Thermoplastic
Net Weight	0.360/g
Number of Rows	1
Orientation	Vertical
PCB Retention	None
Packaging Type	Embossed Tape on Reel
Panel Mount	No
Pitch - Mating Interface	0.65mm
Pitch - Termination Interface	0.65mm
Polarized to Mating Part	Yes
Ports	1
Surface Mount Compatible (SMC)	Yes
Temperature Range - Operating	-30°C to +85°C
Termination Interface: Style	Surface Mount
Waterproof / Dustproof	No

Electrical

Current - Maximum per Contact	1.8A, 1.0A
Grounding to Panel	Yes

EU ELV

Not Relevant

EU RoHS

Compliant

REACH SVHC

Not Contained Per -
ED/30/2017 (7 July
2017)

Halogen-Free

Status

Low-Halogen

Need more information on product environmental compliance?

Email productcompliance@molex.com
Please visit the [Contact Us](#) section for any non-product compliance questions.

China ROHS

ELV

RoHS Phthalates

Green Image

Not Relevant

Not Contained

Search Parts in this Series

[105133 Series](#)

Shield Type	Full Shield
Shielded	Yes
Voltage - Maximum	30V AC (RMS)

Solder Process Data

Duration at Max. Process Temperature (seconds)	010
Lead-free Process Capability	REFLOW
Max. Cycles at Max. Process Temperature	001
Process Temperature max. C	260

Material Info**Reference - Drawing Numbers**

Packaging Specification	PK-105133-001
Product Specification	PS-105133-001-001, PS-47642-001-001, TS-105133-001-001
Sales Drawing	SD-105133-001-000

This document was generated on 08/01/2017

PLEASE CHECK WWW.MOLEX.COM FOR LATEST PART INFORMATION