



Think Automation and beyond...

ø22mm

HW1Z Illuminated Buzzer



Optimal illuminated buzzer for elevators and production sites

- Combination buzzer and pilot light
- Alerts workers of danger with sound and light
- Waterproof construction



IDEC CORPORATION

HW1Z Illuminated Buzzer

Complies with the new EU elevator safety standard

EN81-1/2, the safety rules for the construction and installation of lifts (electric and hydraulic) were revised to EN81-20/50 in July 2014 (effective in September 2017). As GB and JIS standards will follow suit, the requirements in the new rules must be taken into consideration when designing elevators.

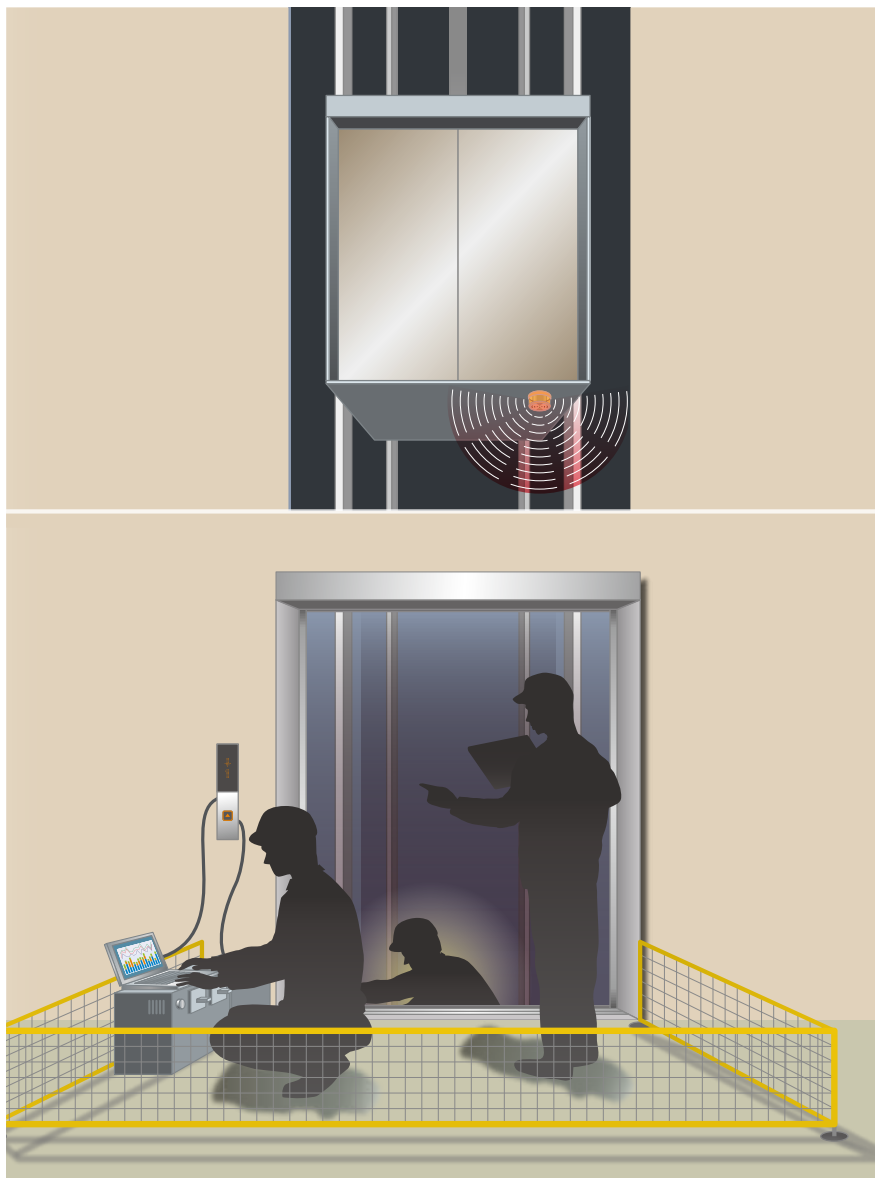

EN81-20 (5.12.1.8.3 g)

An audible signal at the car and a flashing light under the car shall be activated during movement. The sound level of the audible warning shall be minimum 55 dB(A) below the car at 1 m distance.

Can be used in semi-outdoor applications



With waterproof and dust-proof construction, HW1Z can be used in semi-outdoor applications such as elevators exposed to rain and dust.

Meets waterproof requirements for fireman's elevator



HW1Z's IPX3 waterproof characteristics can be used in emergency situations exposed to water.

HW1Z Illuminated Buzzer

Buzzer/lamp in one can be installed easy and quick

Easy wiring and tight installation places

Wiring is accomplished with push-in terminals.
No tightening of screw is required.



Short, 19.7 mm depth behind panel.
Can be installed in tight places.



Lamp and buzzer functions are integrated.

Flashing light

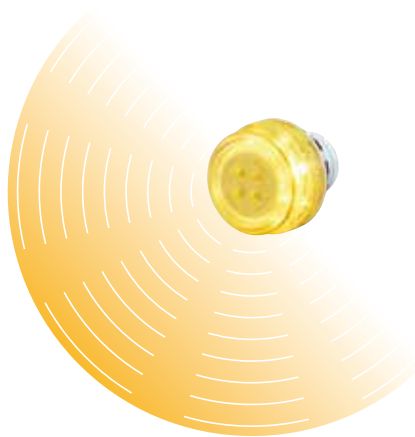

Buzzer sound



Waterproof construction

Panel front: IP65 waterproof



Installing an optional terminal rubber boot upgrades the terminal's waterproof characteristics to IP54 without the need to use a rear enclosure.



HW1Z Illuminated Buzzer

—Other Applications—



▶ Automatic Storage

01

Flashing lights and buzzer sounds alert workers of fast-moving parts in automatic storages.



▶ Production Lines

02

Installed in areas where robots operate, HW1Z alerts workers when they enter potentially hazardous locations.



▶ AGV

03

▶ Control Station

04

HW1Z can be used to alert workers of AGV movement. Also suitable for applications where multiple buzzers are required, such as in a control station.



Model

Shape	Part No.	Illumination Color
	HW1Z-P1F2PQ4R	Red
	HW1Z-P1F2PQ4Y	Yellow

Accessories

Shape	Material	Part No.	Package Quantity	Notes
	Nitril Rubber	HW9Z-CZ1	1	Applicable cable: ø4.5 to 8.5 mm Cut the end of rubber boot to fit the cable size (see dimensions). Weight: 10 g (approx.)

Specifications

Rated Insulation Voltage	30V	
Rated Voltage	12 to 24V DC	
Voltage Range	10.8 to 26.4V DC	
Rated Current (effective value)	18mA (24V DC), 8mA (12V DC)	
Inrush Current	100mA maximum	
Buzzer	Sound Pressure (of HW1Z itself) (at 25°C)	90dB min. at 0.1m (24VDC) 70dB min. at 1m (24V DC, equivalent value) 84dB min. at 0.1m (12V DC) 64dB min. at 1m (12VDC, equivalent value)
	Sound Frequency (at 25°C)	2,200 to 2,450Hz
	Sound Type	Intermittent sound
	Intermittent Cycle (at 25°C)	105 cycles/minute approx. (1.75Hz approx.)
Illumination	Illumination Type	Flashing
	Flash Cycle (at 25°C)	105 cycles/minute approx. (1.75Hz approx.)

Operating Temperature	-20 to +50°C (no freezing)
Operating Humidity	20% to 85% RH (no condensation)
Storage Temperature	-30 to +80°C (no freezing)
Insulation Resistance	100MΩ minimum (at 500V DC megger)
Dielectric Strength	Between live and earthed metal parts: 1000V AC, 1 minute
Vibration Resistance	Operation extremes: 5 to 55Hz, amplitude 0.5mm Damage limits: 5 to 55Hz, amplitude 0.5mm
Shock Resistance	Operation extremes: 100 m/s ² Damage limits: 1,000 m/s ²
Degree of Protection	Panel front: IP65 (IEC 60529) Terminal: IP40 (IEC 60529) IP54 (with terminal rubber boot) (IEC 60529)
Terminal Style	Push-in Terminals
Applicable Wire	Solid wire/ferrule (without sleeve): 0.2 to 1.5 mm ² Ferrule (with sleeve): 0.2 to 0.75 mm ²
Weight (approx.)	17g

Applicable Standards

UL508		File No.E68961
EN60947-5-1		EMC Directive

Dimensions

All dimensions in mm.

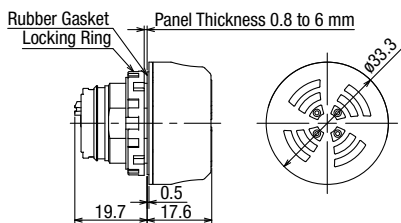

With terminal rubber boot

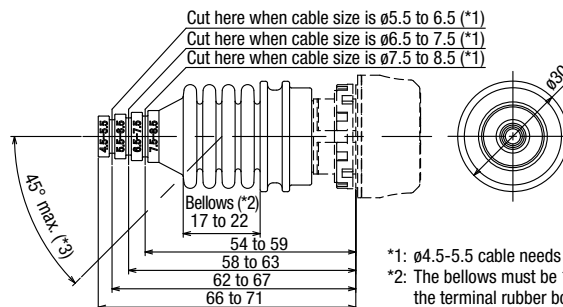

- *1: ø4.5-5.5 cable needs no cutting.
- *2: The bellows must be 17 to 22mm long after installing the terminal rubber boot.
- *3: Maintain a cable angle of 45° max. to the HW1Z axis.

Terminal Arrangement (bottom view)

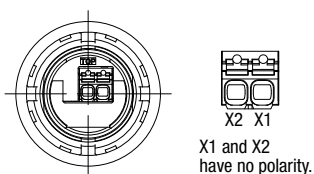

Mounting Hole Layout

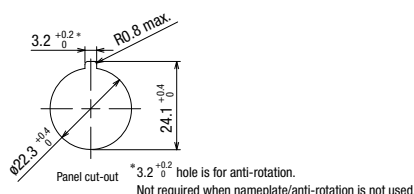

⚠ Safety Precautions

- Turn off the power to the HW1Z before installation, removal, wiring, maintenance, and inspection. Failure to turn power off may cause electrical shocks or fire hazard.
- For wiring, use wires of a proper gauge to meet the voltage and current requirements.

- Prevent metal fragments and pieces of wire from dropping inside when installing or wiring the HW1Z. Otherwise fire, failure, or malfunction may be caused.

Operating Instructions

Panel Mounting

- Insert the HW1Z into the panel cut-out from the front, and tighten the locking ring from the back.

Note for panel mounting

- Use the optional locking ring wrench (MW9Z-T1) to tighten the locking ring to a recommended tightening torque of 1.5 to 2.0 N·m.
- Do not use pliers and do not tighten excessively, otherwise the HW1Z may be damaged.



Wiring

- When using solid wire, strip the wire insulation 8 mm from the end. When using stranded wire, clamp a ferrule and insert into the terminal, and make sure that the wire does not loosen.

Recommended Ferrules

Phoenix Contact

Without sleeve	With sleeve
For 0.5mm ² : A0,5-8	For 0.25mm ² : A10,25-8YE
For 0.75mm ² : A0,75-8	For 0.5mm ² : A10,5-8WH
For 1.0mm ² : A1-8	For 0.75mm ² : A10,75-8GY

Wire removal

Push in the white wire removal part above the wire ports using a small flat screw driver, and pull out the wire.

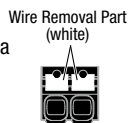

Note for wiring

Make sure that the terminal is not constantly pulled by the wire. Wiring must be performed in environments of -5 to +50°C.

Installing the terminal rubber boot

1. Cut the end of terminal rubber boot to fit the cable size.
2. Insert the cable into the terminal rubber boot in the direction of arrow shown below.

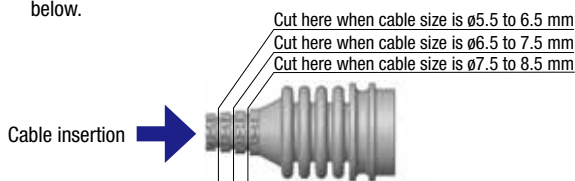

3. Strip the sheath of the cable 30 mm from the end.
Solid wire: strip each wire 8 mm from the end
Stranded wire: clamp the ferrule
Insert the cable into the terminal.

4. Install the terminal rubber boot as shown below.

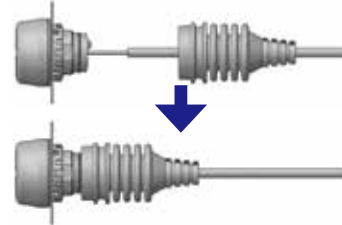

5. Cover part B with part A.



6. Make sure that the bellows is 17 to 22 mm long.

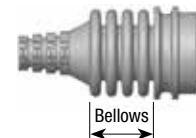

Note for terminal rubber boot

- After installing the terminal rubber boot, make sure that the bellows is 17 to 22 mm long. Waterproof characteristics cannot be achieved with longer bellows.
- Maintain a cable angle of 45° maximum to the axis of the HW1Z, otherwise the terminal rubber boot may come off.

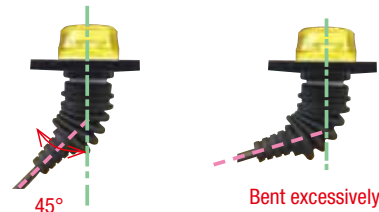

Operating Conditions

Do not use the HW1Z in the following locations.

- Exposed to direct sunlight
- Subject to corrosive or flammable gases

IDEC CORPORATION

Head Office

6-64, Nishi-Miyahara-2-Chome, Yodogawa-ku, Osaka 532-0004, Japan

USA	IDEC Corporation	Tel: +1-408-747-0550	opencontact@idec.com
Germany	IDEC Elektrotechnik GmbH	Tel: +49-40-25 30 54 - 0	service@eu.idec.com
Singapore	IDEC Izumi Asia Pte. Ltd.	Tel: +65-6746-1155	info@sg.idec.com
Thailand	IDEC Asia (Thailand) Co., Ltd	Tel: +66-2-392-9765	sales@th.idec.com
Australia	IDEC Australia Pty. Ltd.	Tel: +61-3-8523-5900	sales@au.idec.com
Taiwan	IDEC Taiwan Corporation	Tel: +886-2-2698-3929	service@tw.idec.com

Hong Kong	IDEC Izumi (H.K.) Co., Ltd.	Tel: +852-2803-8989	info@hk.idec.com
China/Shanghai	IDEC (Shanghai) Corporation	Tel: +86-21-6135-1515	idec@cn.idec.com
China/Shenzhen	IDEC (Shenzhen) Corporation	Tel: +86-755-8356-2977	idec@cn.idec.com
China/Beijing	IDEC (Beijing) Corporation	Tel: +86-10-6581-6131	idec@cn.idec.com
Japan	IDEC Corporation	Tel: +81-6-6398-2527	marketing@idec.co.jp

 www.idec.com

Specifications and other descriptions in this brochure are subject to change without notice.
2017 IDEC Corporation, All Rights Reserved.