

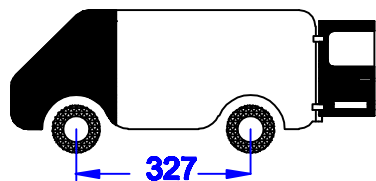

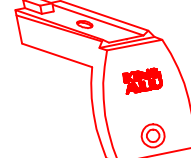

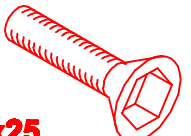

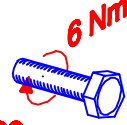

Citroën Jumpy
Peugeot Expert
Toyota ProAce

TYPE M **2016**
STANDAARD **2016**
WORKER **2016**

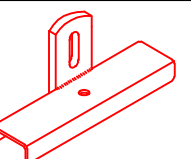

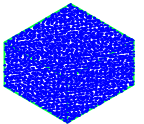
280x141cm. L2 H1

 6x	 8x	 6x
 2x	 16x	 * 6x
 8x	 16x	 * 6x
 16x		 * 6x

MONTAGEFILM KING-ALU IMPERIAAL

**P= ALS LAATSTE
 ONDER SPANNING ZETTEN
 ALLEEN AAN DE VOORKANT**

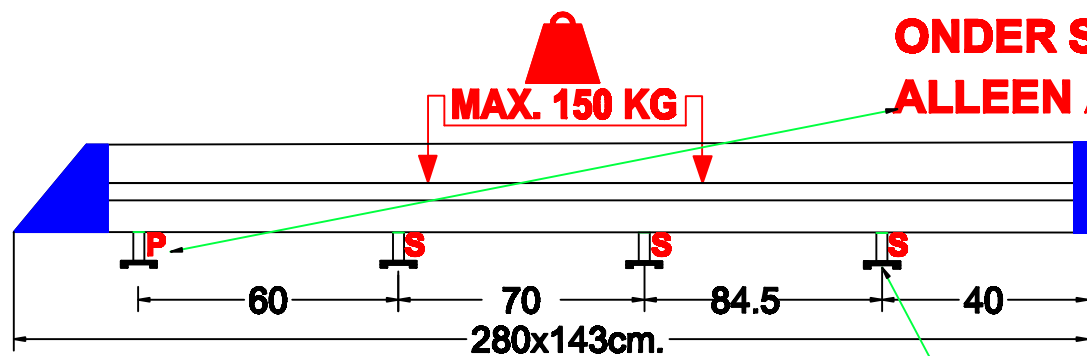

**ALS EERSTE ACHTERSTE
 STEUN VAST ZETTEN**

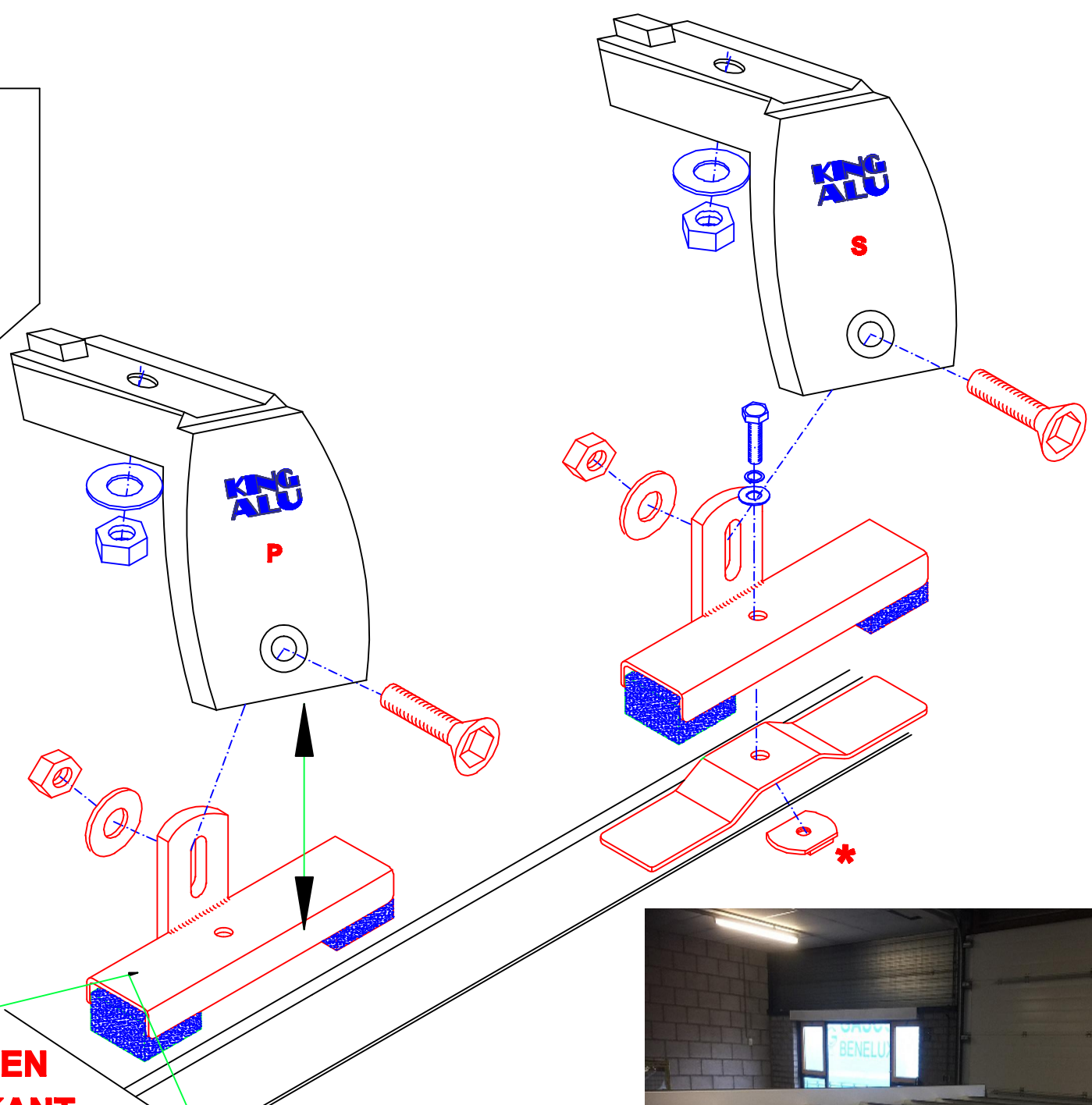

let op deze niet gebruiken

2806 ALUPEL2H1D / ALUCJL2H1D / ALUTPL2H1D 02/2017