

## MSUD VALVE PLUG FORM BI 11MM

PUR 3X0.75 GRAY, 5m

Form BI (11 mm) industrial standard  
24 V AC/DC with LED and suppression  
180°, PE opposite cable outlet

Further cable lengths on request. Plastic housings with good resistance against chemicals and oils. The resistance to aggressive media should be individually tested for your application. Further details on request.

### [Link to Product](#)

#### Illustration

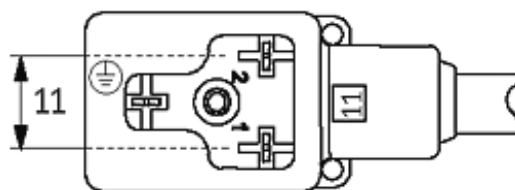
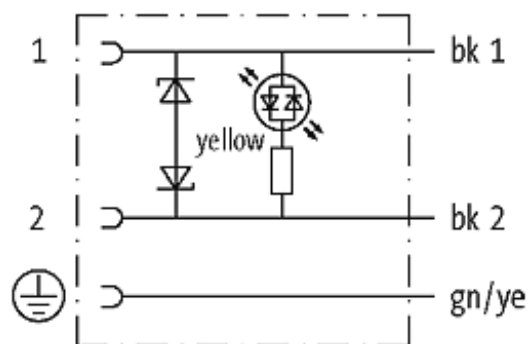

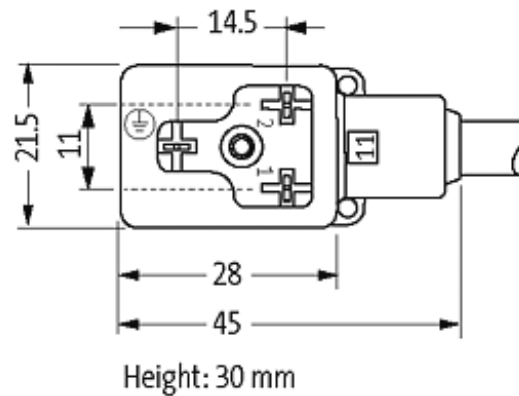

Product may differ from Image

### Approvals



### Form

11081

### Technical Data

Operating voltage	24 V AC/DC $\pm 25\%$
Operating current per contact	max. 4 A
Switch off peak	max. 55 V
Switch off delay time	max. 20 ms
Locking of ports	M3 (recommended torque 0.4 Nm)
Protection	IP67 inserted and tightened (EN 60529)
Housing	Black plastic (gray on request)

### Cables

Cable number	226
No./diameter of wires	3 $\times$ 0.75 mm <sup>2</sup>
Wire isolation	PVC (bk, num, gnye)
C-track properties	2 Mio.
Jacket Color	gray
Shore hardness outer jacket	85 $\pm$ 5A
Material (jacket)	PUR/PVC (UL/CSA)
Outer diameter	approx. 5.9 mm
Bend radius (fixed)	10 $\times$ outer $\varnothing$
Bend radius (moving)	15 $\times$ outer $\varnothing$
Temperature range (fixed)	-30...+80 °C
Temperature range (mobile)	-5...+80 °C

### General data

Temperature range	-25...+85 °C, depending on cable quality
-------------------	--

**Commercial data**

country of origin	CZ
customs tariff number	85444290
minimum order quantity	1