



ACCES.F.FUSE SWI. DISCONNECTOR FOR NH000
FUSE CARRIER

Figure similar

Model	
product brand name	SENTRON
Design of the product	for 3NP1 fuse switch disconnectors, fuse carrier standard, without fuse monitoring, for size NH000

Accessories	
accessories	cover

General Product Approval	Declaration of Conformity
--------------------------	---------------------------



Further information

Information- and Downloadcenter (Catalogs, Brochures,...)
<http://www.siemens.com/lowvoltage/catalogs>

Industry Mall (Online ordering system)
<https://eb.automation.siemens.com/mall/en/WW/Catalog/Product/3NP19231GA00>

Service&Support (Manuals, Certificates, Characteristics, FAQs,...)
<http://support.automation.siemens.com/WW/view/en/3NP19231GA00/all>

Image database (product images, 2D dimension drawings, 3D models, device circuit diagrams, ...)
http://www.automation.siemens.com/bilddb/cax_en.aspx?mlfb=3NP19231GA00

CAX-Online-Generator
<http://www.siemens.com/cax>

Tender specifications
<http://ausschreibungstexte.siemens.com/tiplv>

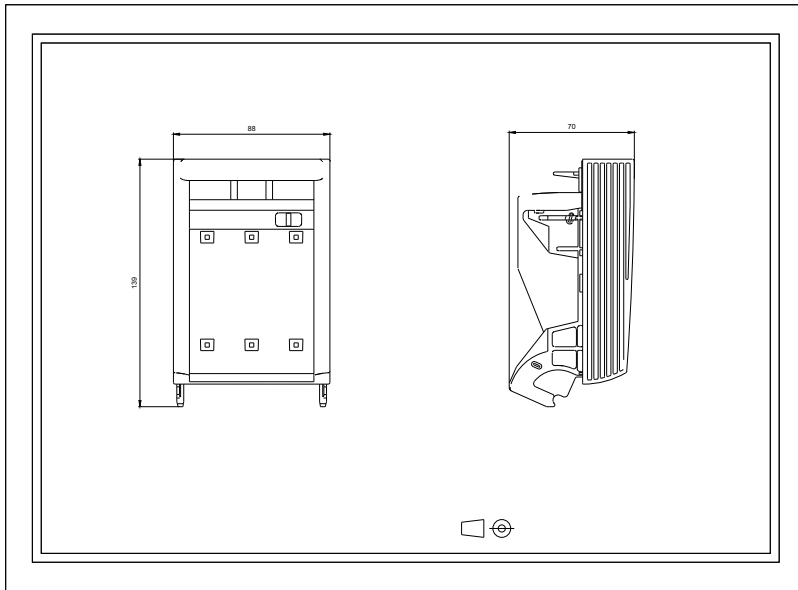

last modified:

11.03.2015