



## Main

Product Type	Power relay
Switch Function	SPST-NO-DM
Contact Composition	1 NO
Cover Type	Open cover

## Complementary

Input Current	40 A
Contacts Material	Silver alloy contacts
Contact Operation	Double action
Rated Operational Voltage	6...600 V AC 50...60 Hz 6...250 V DC
Minimum Switching Current	1000 mA at 5 V AC/DC
Coil Resistance	70 Ohm
Input Voltage	12 V DC
Drop-out Voltage Threshold	$\geq 0.1 U_c$ AC/DC
Rated Operational Current	40 A at 300 V AC (on resistive load) conforming to UL 40 A at 28 V DC (on resistive load) conforming to UL 12 A at 480 V AC (on resistive load) conforming to UL 10 A at 600 V AC (on resistive load) conforming to UL 15 A at 120 V AC (tungsten filament) conforming to UL
Power consumption in W	4 W DC
Power consumption in VA	10 VA AC
Voltage Range	0.85...1.1 $U_n$ AC/DC
Maximum Switching Voltage	600 V DC
Motor Power HP	2 hp at 120...600 V AC 50/60 Hz
Connections Terminals	Screw terminal
Wire Range	AWG 14
Terminal Tightening Torque	10.62...15.05 lbf.in (1.2...1.7 N.m)

## Environment

Ambient Air Temperature for Operation	-67...131 °F (-55...55 °C)
Ambient Air Temperature for Storage	-67...212 °F (-55...100 °C)
Product Certifications	UL Listed CSA CE RoHS
Electrical Durability	100000 cycles resistive DC load
Dielectric Strength	2200 V AC between coil and contact 2200 V AC between poles 1500 V AC between open contacts

The information provided in this documentation contains general descriptions and/or technical characteristics of the performance of the products contained herein. This documentation is not intended as a substitute for and is not to be used for determining suitability or reliability of these products for specific user applications. It is the duty of any such user or integrator to perform the appropriate and complete risk analysis, evaluation and testing of the products with respect to the relevant specific application or use thereof. Neither Schneider Electric Industries SAS nor any of its affiliates or subsidiaries shall be responsible or liable for misuse of the information contained herein.

## Ordering and shipping details

GTIN	03606480276002
------	----------------

## Offer Sustainability

Sustainable offer status	Green Premium product
California proposition 65	WARNING: This product can expose you to chemicals including: Nickel compounds, which is known to the State of California to cause cancer, and Di-isodecyl phthalate (DIDP), which is known to the State of California to cause birth defects or other reproductive harm. For more information go to <a href="http://www.P65Warnings.ca.gov">www.P65Warnings.ca.gov</a>
REACH Regulation	<a href="#">REACH Declaration</a>
REACH free of SVHC	Yes
EU RoHS Directive	Pro-active compliance (Product out of EU RoHS legal scope) <a href="#">EU RoHS Declaration</a>
Toxic heavy metal free	Yes
Mercury free	Yes
RoHS exemption information	<a href="#">Yes</a>
China RoHS Regulation	<a href="#">China RoHS Declaration</a>
Environmental Disclosure	<a href="#">Product Environmental Profile</a>
WEEE	The product must be disposed on European Union markets following specific waste collection and never end up in rubbish bins.

Approximate Dimensions

DPST-NO

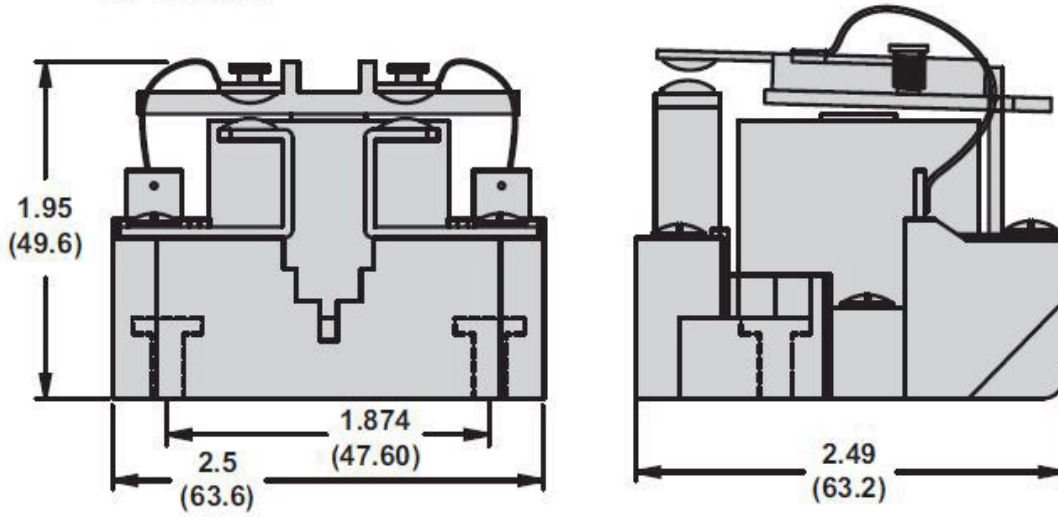

---

Connections and Wiring Diagrams

---

