

SGX

SENSORTECH

An Amphenol Company

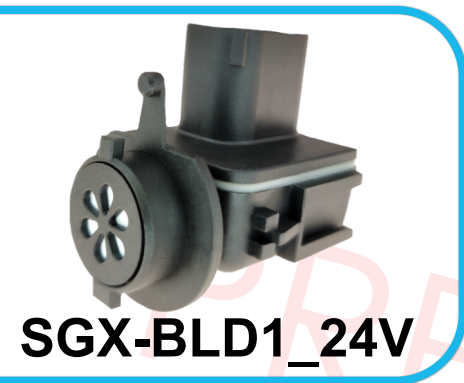
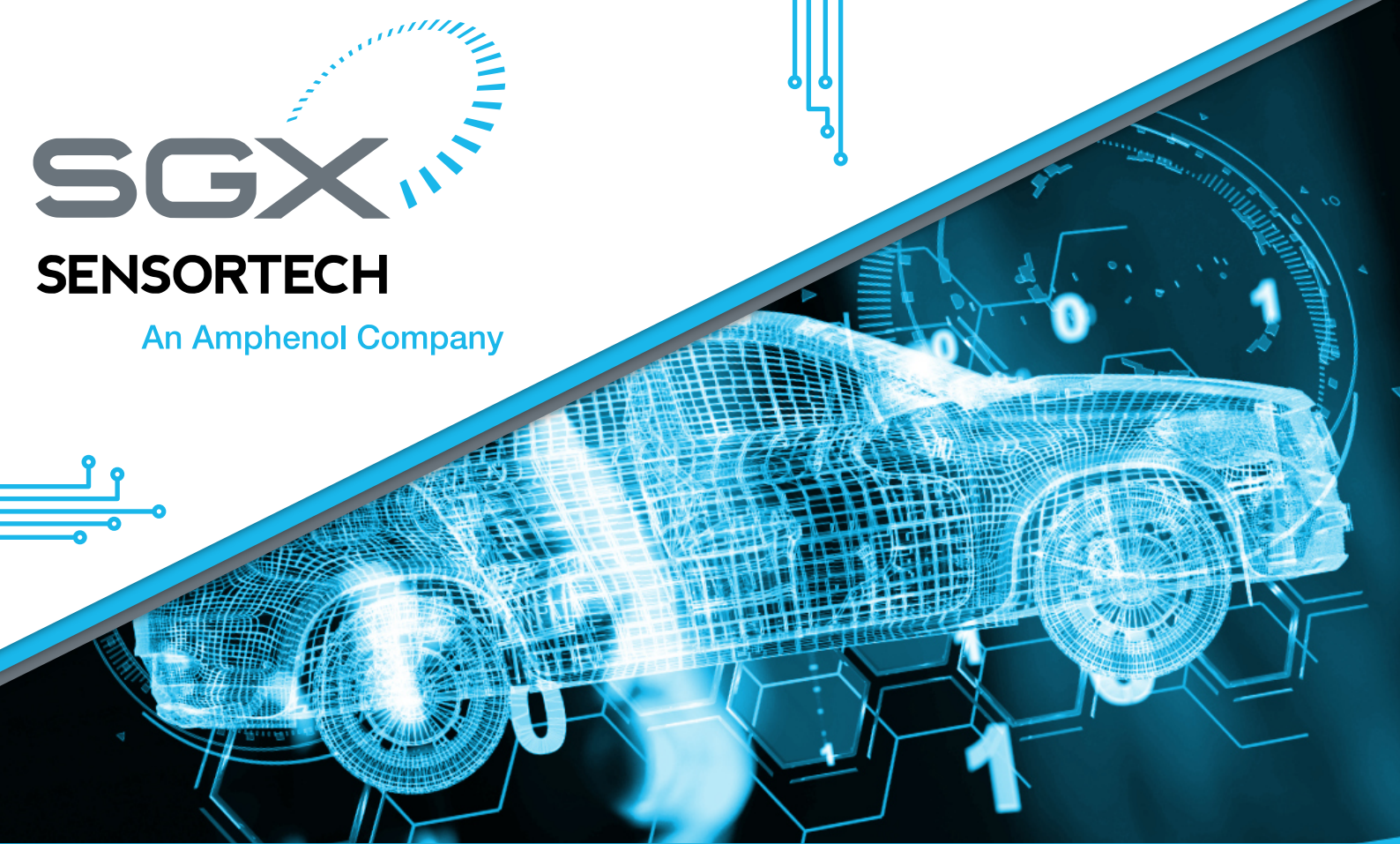

Hydrogen Detection Sensor Datasheet

SGX-BLD1_24V is a Hydrogen detection sensor that measures H₂ concentration when different battery leakage occur through CAN communication.

The sensor module has to be placed near the Hydrogen storage system or in the battery enclosure allowing to sense H₂ gas generated during a leakage or Li-ion battery Thermal Runaway failure mode.

The **SGX-BLD1_24V** solution will allow the Vehicle Management System or Battery Management System to monitor the safe operation of the hydrogen system or Li-ion battery and generate an **early warning signal** when a leakage occurs or a Thermal Runaway event happens, this so that passengers can leave the vehicle early.



Quality, Safety, Responsibility

Functional specifications

Features

- Automotive product
- Fast response time (< 1 s)
- Thermal conductivity gas sensor (high reliability technology)
- High H₂ range detection from 0 up to 4%
- Low power consumption (25mA)
- CAN 500kbps High Speed communication
- Standard automotive 4 pins connector
- Watertight housing IP6K7
- Configurable ID
- 24V version, max working voltage 32V

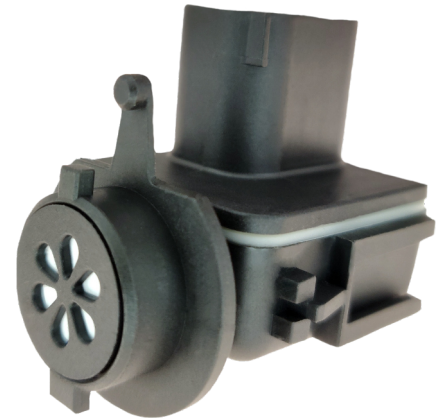

Principle

There are different failure modes possible in the hydrogen fuel-cell or li-ion battery system. To prevent a dangerous situation for passengers, the Fuel-cell or Battery management system should send an alarm to the passengers to leave.

Inside Li-ion battery packs, our sensors can robustly and early detect the hydrogen gas during various failure modes of a thermal runaway event. Other sensing technologies, like pressure measurements, often only detect some of these failure modes and will not work well in all battery pack architectures as venting solutions can prevent a pressure increase detection.

See below some failure mode examples with a comparison between H₂ SGX sensor and a pressure sensor:

Cell Overcharge:

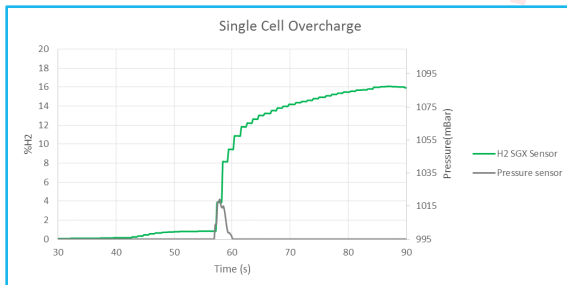

- The H₂ sensor (**green curve**) is reacting 10 seconds faster than the pressure sensor
- Small pressure increase in short period (**gray curve**) and similar to environment change

Pressure sensor reference for testing: NPA-201

Cell Re-Overcharge:

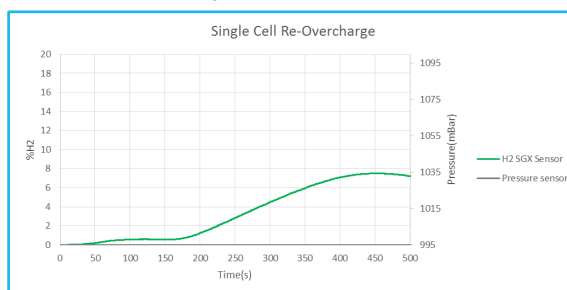

- The H₂ sensor is reacting (**green curve**).
- The pressure sensor **is not reacting** (**gray curve**).

Pressure sensor reference for testing: NPA-201

Cell Nail penetration:

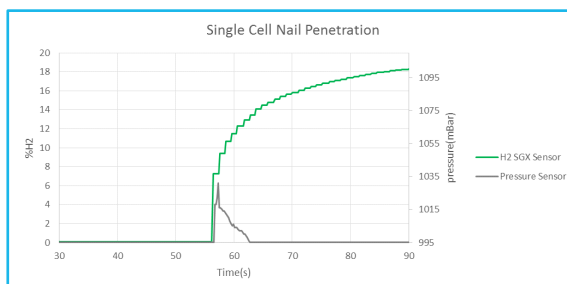

- The H₂ sensor is reacting (**green curve**) faster than the pressure sensor (**gray curve**).
- Small pressure increase in short period (**gray curve**) and similar to environment change.

Pressure sensor reference for testing: NPA-201

Main technical characteristics

Temperature and humidity range	0~95% RH -40°C to +85°C
Temperature storage	-40°C to 120°C
IP level	IP6K7
Fixing	Bayonet Delphi clip (optional)
Connector	4 pins Tyco Electronics AMP-1-0967640-1 coding A
External dimensions	39mm x 35mm x 27 mm
Weight	< 15 g
Power supply operating range	9 to 36V
Current consumption (Average)	sampling 500ms-> 28 mA, @24V
Output signal	CAN 500kbps High Speed
H2 detection	0 - 4 % (guaranted)
Accuracy	± 0.4% H2 @ 23°C < 10%RH ¹
Response time	< 0.5 s (one CAN frame sent every 500ms)
Start-up time	< 400ms
Lifetime	10 years or 13000h ²

¹ in stable hydrogen concentration / this will increase if the life time need to be higher

² Can be higher with a lower measurement frequency and depend on detection time target

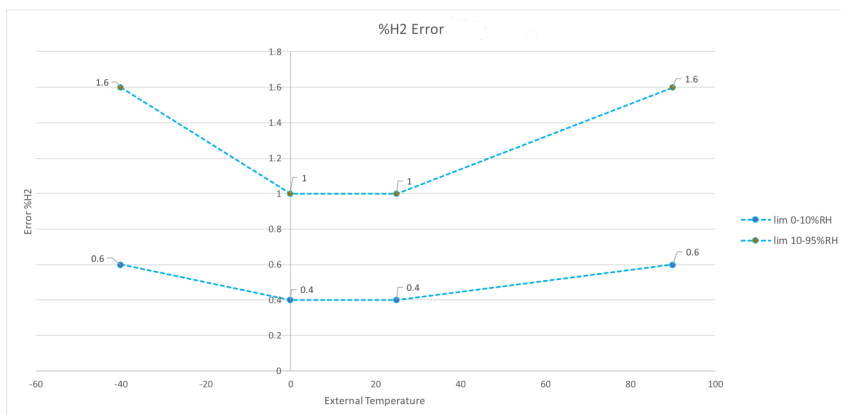

SGX-BLD1_24V

Interface and integration

Principle

Connector type	Tyco Electronics AMP-1-0967640-1 coding A
Communication	500kbps High Speed
Pinout	Pin1: Vbat Pin2: Ground Pin3: CAN Low Pin4: CAN High

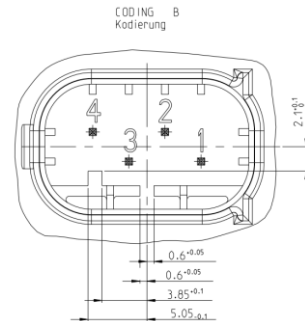

Recommendation for integration

The sensor must be exposed to measure the air from the **battery pack only**. Preferably, the filtering membrane included in the module should be facing downward. If this is not possible, it should be vertical, but should never be facing upward, to prevent accumulation of dirt, water.

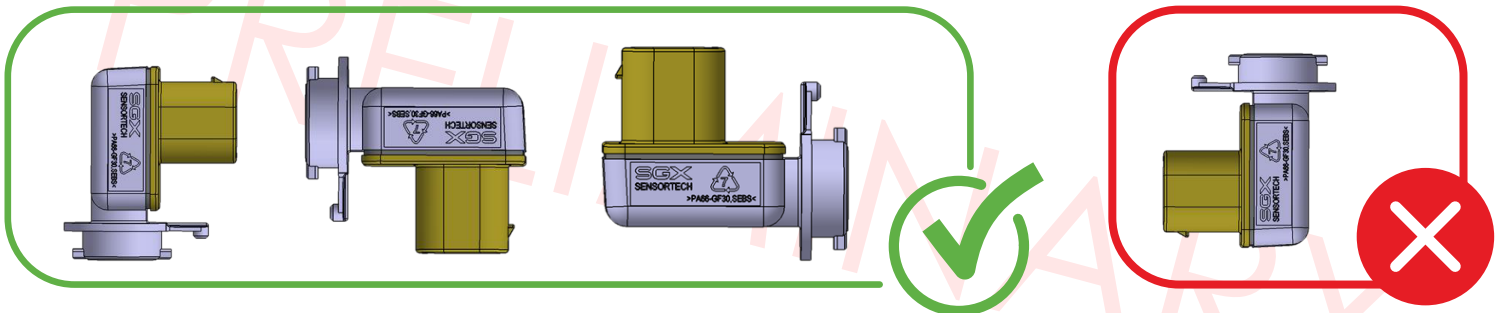

Bayonet fixing, mating with following interface:

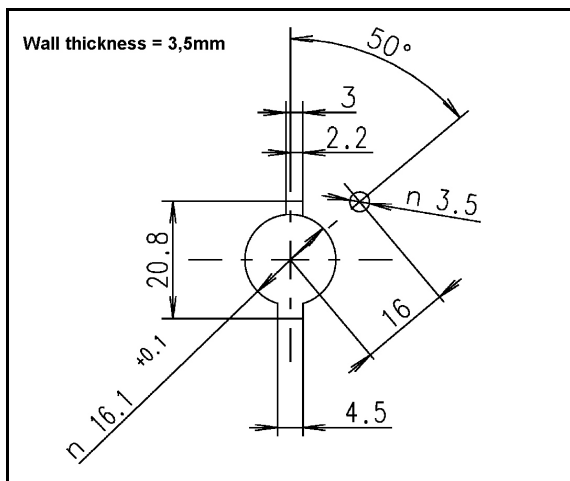

Optional, the sensor can be mounted with a standard Delphi-clip.

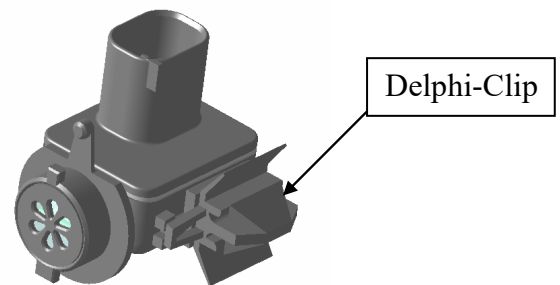

Recommended hole for Delphi-Clip

15±0.1mm

8±0.1mm

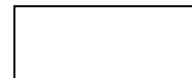

Sheet Metal Thickness (Max) 0.8 – 2.8mm

Proposed CAN frame description

The default ID is 0x256 and CAN frame layout is as shown below:

	7	6	5	4	3	2	1	0
0	Temperature_u8 msb 7	6	5	4	3	2	1	lsb 0
1	msb 15	14	13	12	11	10	9	8
2	Hydrogen_u16 23	22	21	20	19	18	17	lsb 16
3	31	Sensor_replacement 30	undervoltage 29	Temperature_issue 28	H2_out_of_range 27	RH_issue 26	TC_issue 25	overvoltage 24
4	Voltage_u8 msb 39	38	37	36	35	34	33	lsb 32
5	Humidity_u8 msb 47	46	45	44	43	42	41	lsb 40
6	55	54	53	52	Roll_Counter_u8 msb 51	50	49	lsb 48
7	63	62	61	60	59	58	57	56

Signal factor and offset are described below:

Name	Message	Start bit	Length	Byte Order	Value Type	Initial Value	Factor	Offset	Min.	Max.	Unit
Temperature (u8)	Sensor_Status_1	0	8	Intel	Unsigned	-55	1	-55	-55	195	°C
Hydrogen percent (u16)	Sensor_Status_1	16	16	Motorola	Unsigned	0	0.01	0	0	100	%
Overvoltage	Sensor_Status_1	24	1	Intel	Unsigned	0	1	0	0	0	
TC issue	Sensor_Status_1	25	1	Intel	Unsigned	0	1	0	0	0	
RH issue	Sensor_Status_1	26	1	Intel	Unsigned	0	1	0	0	0	
H2 out of range	Sensor_Status_1	27	1	Intel	Unsigned	0	1	0	0	0	
Temperature issue	Sensor_Status_1	28	1	Intel	Unsigned	0	1	0	0	0	
Undervoltage	Sensor_Status_1	29	1	Intel	Unsigned	0	1	0	0	0	
Sensor replacement	Sensor_Status_1	30	1	Intel	Unsigned	0	1	0	0	0	
Low power bit	Sensor_Status_1	31	1	Intel	Unsigned	0	1	0	0	0	
Voltage (u8)	Sensor_Status_1	32	8	Motorola	Unsigned	0	0.1	0	0	25.5	V
Humidity (u8)	Sensor_Status_1	40	8	Motorola	Unsigned	20	0.5	0	0	100	%
Roll Counter (u4)	Sensor_Status_1	48	4	Motorola	Unsigned	0	1	0	0	15	

- Voltage, Temperature and Humidity are internal for Hydrogen compensation purpose
- Hydrogen is the output of the sensor in %
- The bits are for diagnosis purpose
- Roll counter is a counter that increases from 0 to 15, with an increase of 1 at each frame sending

DISCLAIMER:

SGX Europe Sp. z o.o. reserves the right to change design features and specifications without prior notification. We do not accept any legal responsibility for customer applications of our sensors. SGX Europe Sp. z o.o. accepts no liability for any consequential losses, injury or damage resulting from the use of this document, the information contained within or from any omissions or errors herein. This document does not constitute an offer for sale and the data contained is for guidance only and may not be taken as warranty. Any use of the given data must be assessed and determined by the user thereof to be in accordance with federal, state and local laws and regulations. All specifications outlined are subject to change without notice.

SGX Europe Sp. z o.o. sensors are designed to operate in a wide range of harsh environments and conditions. However, it is important that exposure to high concentrations of solvent vapours is to be avoided, both during storage, fitting into instruments and operation. When using sensors on printed circuit boards (PCBs), degreasing agents should be used prior to the sensor being fitted. SGX Europe Sp. z o.o. makes every effort to ensure the reliability of its products. Where life safety is a performance requirement of the product, we recommend that all sensors and instruments using these sensors are checked for response to gas before use.

Copyright© 2012-2023 SGX Sensortech All rights reserved.

Trademarks and registered trademarks are the property of their respective owners.

No part of this publication may be reproduced, distributed, or transmitted in any form or by any means, including photocopying, recording, or other electronic or mechanical methods, without the prior written permission of the publisher, except in the case of brief quotations embodied in critical reviews and certain other non-commercial uses permitted by copyright law.

For permission requests or technical support please contact or write to the publisher, addressed "Attention: Permissions Coordinator."