

ART.: 8432174136310

EB432 LED FLOOD REFLECTOR

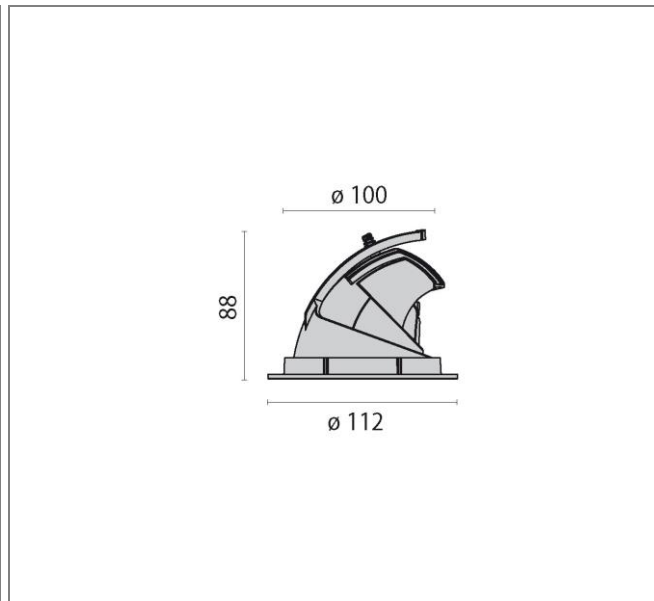

Art.: 8432174136310, EB432 LED, 14W, 3000K, Driver dali, direkt / flood (2 x 23°-29°), White, Recessed LED luminaire for indoors, consisting of: Die-cast aluminum spotlight body and ring, powder-coated, Reflector can be swivelled horizontally inwards and outwards thanks to the unique swivel mechanism, Adjustable about 60° (from -15° up to 45°, rotatable about 355°, High-brilliance spherical faceted reflector for maximum lamp performance and neutral colour rendering, Reflector in Flood design, Colour rendering index Ra > 90, Colour tolerance according to MacAdam ≤ 3 SDCM Toolless mounting, Complete with electric converter, Anchor springs, Complete with clear safety glass pane

Connected load	14 W
Luminous flux	1300 lm
Efficiency	93 lm/W
Colour temperature	3000K
Colour rendering (CRI)	80
IP class	20
Nominal voltage	220 – 240 V
Colour	RAL 9010

