

MAVOWATT | 30

Power | Visa

USER'S GUIDE



MAVOWATT | 30

Power | Visa

(PowerVisa™ PX5)

USER'S GUIDE



WARNING

Death, serious injury, or fire hazard could result from improper connection of this instrument. Read and understand this manual before connecting this instrument. Follow all installation and operating instructions while using this instrument.

Connection of this instrument must be performed in compliance with the National Electrical Code (ANSI/NFPA 70-2005) of USA and any additional safety requirements applicable to your installation.

Installation, operation, and maintenance of this instrument must be performed by qualified personnel only. The National Electrical Code defines a qualified person as “one who has the skills and knowledge related to the construction and operation of the electrical equipment and installations, and who has received safety training on the hazards involved.”

Qualified personnel who work on or near exposed energized electrical conductors must follow applicable safety related work practices and procedures including appropriate personal protective equipment in compliance with the Standard for Electrical Safety Requirements for Employee Workplaces (ANSI/NFPA 70E-2004) of USA and any additional workplace safety requirements applicable to your installation.

GMC-I Gossen-Metrawatt GmbH

Thomas-Mann-Str. 16-20
90471 Nürnberg • Germany
Phone: +49 911 8602-111
Fax: +49 911 8602-777
E-Mail: info@gossenmetrawatt.com
Web site: www.gossenmetrawatt.com

Repair and Replacement Parts Service

Phone: +49 911 8602-0
Fax: +49 911 8602-253
E-Mail service@gossenmetrawatt.com

Product Support Hotline

Phone +49 911 8602-112
Fax +49 911 8602-709
E-Mail support@gossenmetrawatt.com

Published by Dranetz-BMI
1000 New Durham Road
Edison, NJ 08818-4019 USA
Telephone: 1-800-372-6832 or 732-287-3680
Fax: 732-248-1834
Web site: www.dranetz-bmi.com

Copyright © 2005 Dranetz-BMI
All rights reserved.

No part of this book may be reproduced, stored in a retrieval system, or transcribed in any form or by any means—electronic, mechanical, photocopying, recording, or otherwise—without prior written permission from the publisher, Dranetz-BMI, Edison, NJ 08818-4019.

Printed in the United States of America.

ADVERTENCIA

Una conexión incorrecta de este instrumento puede producir la muerte, lesiones graves y riesgo de incendio. Lea y entienda este manual antes de conectar. Observe todas las instrucciones de instalación y operación durante el uso de este instrumento.

La conexión de este instrumento debe ser hecha de acuerdo con las normas del Código Eléctrico Nacional (ANSI/NFPA 70-2005) de EE. UU., además de cualquier otra norma de seguridad correspondiente a su establecimiento.

La instalación, operación y mantenimiento de este instrumento debe ser realizada por personal calificado solamente. El Código Eléctrico Nacional define a una persona calificada como "una que esté familiarizada con la construcción y operación del equipo y con los riesgos involucrados."

AVERTISSEMENT

Si l'instrument est mal connecté, la mort, des blessures graves, ou un danger d'incendie peuvent s'en suivre. Lisez attentivement ce manuel avant de connecter l'instrument. Lorsque vous utilisez l'instrument, suivez toutes les instructions d'installation et de service.

Cet instrument doit être connecté conformément au National Electrical Code (ANSI/NFPA 70-2005) des Etats-Unis et à toutes les exigences de sécurité applicables à votre installation.

Cet instrument doit être installé, utilisé et entretenu uniquement par un personnel qualifié. Selon le National Electrical Code, une personne est qualifiée si "elle connaît bien la construction et l'utilisation de l'équipement, ainsi que les dangers que cela implique".

WARNUNG

Der falsche Anschluß dieses Gerätes kann Tod, schwere Verletzungen oder Feuer verursachen. Bevor Sie dieses Instrument anschließen, müssen Sie die Anleitung lesen und verstanden haben. Bei der Verwendung dieses Instruments müssen alle Installation- und Betriebsanweisungen beachtet werden.

Der Anschluß dieses Instruments muß in Übereinstimmung mit den nationalen Bestimmungen für Elektrizität (ANSI/NFPA 70-2005) der Vereinigten Staaten, sowie allen weiteren, in Ihrem Fall anwendbaren Sicherheitsbestimmungen, vorgenommen werden.

Installation, Betrieb und Wartung dieses Instruments dürfen nur von Fachpersonal durchgeführt werden. In dem nationalen Bestimmungen für Elektrizität wird ein Fachmann als eine Person bezeichnet, welche "mit der Bauweise und dem Betrieb des Gerätes sowie den dazugehörigen Gefahren vertraut ist."

Safety Summary

Definitions

WARNING statements inform the user that certain conditions or practices could result in loss of life or physical harm.

CAUTION statements identify conditions or practices that could harm the PowerVisa, its data, other equipment, or property.

NOTE statements call attention to specific information.

Symbols

The following International Electrotechnical Commission (IEC) symbols are marked on the top and rear panel in the immediate vicinity of the referenced terminal or device:



Caution, refer to accompanying documents (this manual).



Direct current (DC) operation of the terminal or device.



Power Switch

Definiciones

Las ADVERTENCIAS informan al usuario de ciertas condiciones o prácticas que podrían producir lesiones mortales o daño físico.

Las PRECAUCIONES identifican condiciones o prácticas que podrían dañar la PowerVisa, sus datos, otros equipos o propiedad.

Las NOTAS llaman la atención hacia la información específica.

Símbolos

Los siguientes símbolos de la Comisión Internacional Electrotécnica (IEC) aparecen marcados en el panel superior y el posterior inmediatos al terminal o dispositivo en referencia:



Precaución, consulte los documentos adjuntos (este manual).



Operación de corriente continua (CC) del terminal o dispositivo.



Interruptor de encendido

Continued on next page

Safety Summary, Continued

Définitions

Les messages d'AVERTISSEMENT préviennent l'utilisateur que certaines conditions ou pratiques pourraient entraîner la mort ou des lésions corporelles.

Les messages de MISE EN GARDE signalent des conditions ou pratiques susceptibles d'endommager "PowerVisa", ses données, d'autres équipements ou biens matériels.

Les messages NOTA attirent l'attention sur certains renseignements spécifiques.

Symboles

Les symboles suivants de la Commission électrotechnique internationale (CEI) figurent sur le panneau arrière supérieur situé à proximité du terminal ou de l'unité cité:



Mise en garde, consultez les documents d'accompagnement (ce manual).



Fonctionnement du terminal ou de l'unité en courant continu (CC).



Interrupteur de tension

Definitionen

WARNUNGEN informieren den Benutzer darüber, daß bestimmte Bedingungen oder Vorgehensweisen körperliche oder tödliche Verletzungen zur Folge haben können.

VORSICHTSHINWEISE kennzeichnen Bedingungen oder Vorgehensweisen, die zu einer Beschädigung von PowerVisa, seiner Daten oder anderer Geräte bzw. von Eigentum führen können.

Symbole

HINWEISE machen auf bestimmte Informationen aufmerksam.

Die folgenden Symbole der Internationalen Elektrotechnischen Kommission (International Electrotechnical Commission; IEC) befinden sich auf der Abdeck- und Seitenplatte unmittelbar am betreffenden Terminal oder Gerät.



Vorsichtshinweis, siehe Begleitdokumente (dieses Handbuch).



Gleichstrombetrieb im Terminal oder Gerät.



Netzschalter

Continued on next page

Safety Summary, Continued

Safety precautions

The following safety precautions must be followed whenever any type of voltage or current connection is being made to the PowerVisa.

- Wear proper Personal Protective Equipment, including safety glasses and insulated gloves when making connections to power circuits.
- Hands, shoes and floor must be dry when making any connection to a power line.
- Before each use, inspect all cables for breaks or cracks in the insulation. Replace immediately if defective.
- Set the PowerVisa power switch to Off.
- Before connecting to electric circuits to be monitored, open their related circuit breakers or disconnects. DO NOT install any connection of the PowerVisa to live power lines.
- Connections must be made to the PowerVisa first, then connect to the circuit to be monitored.

These safety precautions are repeated where appropriate throughout this manual.

Statements and Notices

Statement of warranty

All products of Dranetz-BMI are warranted to the original purchaser against defective material and workmanship for a period of one year from the date of delivery. Dranetz-BMI will repair or replace, at its option, all defective equipment that is returned, freight prepaid, during the warranty period. There will be no charge for repair provided there is no evidence that the equipment has been mishandled or abused. This warranty shall not apply to any defects resulting from improper or inadequate maintenance, buyer-supplied hardware/software interfacing, unauthorized modification or misuse of the equipment, operation outside of environmental specifications, or improper site preparation or maintenance.

Statement of reliability

The information in this manual has been reviewed and is believed to be entirely reliable, however, no responsibility is assumed for any inaccuracies. All material is for informational purposes only and is subject to change without prior notice.

Notice regarding FCC compliance

This device has been tested and found to comply with the limits for a Class A digital device, pursuant to Part 15 of the FCC Rules. These limits are designed to provide reasonable protection against harmful interference when the equipment is operated in a commercial environment. This equipment generates, uses, and can radiate radio frequency energy and, if not installed and used in accordance with the instruction manual, may cause harmful interference to radio communications. Operation of this equipment in a residential area is likely to cause harmful interference in which case the user will be required to correct the interference at his/her own expense.

Notice regarding proprietary rights

This publication contains information proprietary to Dranetz-BMI. By accepting and using this manual, you agree that the information contained herein will be used solely for the purpose of operating equipment of Dranetz-BMI.

Continued on next page

Statements and Notices, Continued

Copyright

This publication is protected under the Copyright laws of the United States, Title 17 et seq. No part of this publication may be reproduced, transmitted, transcribed, stored in a retrieval system, or translated into any language or computer language, in any form, by any means, electronic, mechanical, magnetic, optical, chemical, manual, or otherwise, without the prior written consent of Dranetz-BMI, 1000 New Durham Road, Edison, New Jersey 08818.

Copyright © 2005 Dranetz-BMI
All Rights Reserved. Printed in the United States of America.

Trademarks

PowerVisa, Scope Mode, NodeLink and DranView are registered trademarks of Dranetz-BMI.

Table of Contents

Safety Summary	iv
Statements and Notices.....	vii
CHAPTER 1 - Getting Started	
Overview	1-1
Unpacking the PowerVisa	1-3
Standard Accessories.....	1-4
PowerVisa Controls, Indicators, and Connectors.....	1-5
Top and Side Views	1-6
Front View	1-7
Bottom View.....	1-8
Rear View	1-9
Upgrading Firmware from a Data Card.....	1-10
PowerVisa Features	1-12
Basic Operation	1-14
Power-on Sequence.....	1-15
Home Screen Icons	1-16
CHAPTER 2 - Voltage Measurement Cable and Current Probe Connections	
Overview	2-1
Connecting Voltage Measurement Cables	2-4
Connecting Current Probes.....	2-9
CHAPTER 3 - View Real Time Data	
Overview	3-1
Section A -Scope Mode	3-2
Overview	3-2
Turning Channels On/Off.....	3-3
Checking Input Range	3-4
Section B -Meter Mode.....	3-5
Overview	3-5
Standard Meter Tab	3-6
Distortion Meter Tab	3-8
Section C -Harmonics	3-10
Overview	3-10
Harmonic Graph	3-11
Harmonic Detail	3-12
Harmonic Options.....	3-13
Harmonic List.....	3-15
Section D -Voltage and Current Phasor.....	3-16
Overview	3-16
Phasor Screen	3-17
Phasor Rotation.....	3-18
Phasor Parameter/Channel Selection.....	3-20

Table of Contents, Continued

CHAPTER 4 - Instrument Settings

Overview	4-1
Access Instrument Settings Menu	4-2
Time and Date Settings.....	4-3
Select Language.....	4-5
Set Display Preferences	4-6
Touch Screen Calibration	4-7
Turn Threshold Beeper On/Off	4-9
Communications.....	4-10
Data Card.....	4-12
Reset to Factory Configurations.....	4-14

CHAPTER 5 - Start Menu

Overview	5-1
Section A -Automatic Setup.....	5-3
Section B -Wizard Setup.....	5-5
Overview	5-5
Current Probe Selection.....	5-7
Scale Factor Setup	5-9
Circuit Type Selection.....	5-11
Nominal Values	5-13
Mode of Operation.....	5-16
Monitoring Mode.....	5-17
Advanced Options	5-18
Site Name/Memory Card.....	5-19
Section C -Monitor Same Circuit.....	5-23
Overview	5-23
Turning Monitoring On/Off.....	5-24
Monitoring at a Specified Time and Date	5-27
Modify Trigger Parameters and Intervals.....	5-32
Section D -Load Setup Template from Card.....	5-33
Section E -Load Data from Card.....	5-34
Overview	5-34
Loading Data from Card.....	5-34
Card Error Messages	5-35

CHAPTER 6 - Advanced Setup Options

Overview	6-1
Advanced Options Menu.....	6-2
Transient Limit	6-3

Table of Contents, Continued

RMS Variation Limit.....	6-8
Waveform Capture	6-13
Characterizer Options	6-14
Journal Limit.....	6-15
Journal Interval for Timed Readings.....	6-18
EN50160 Power Quality (for strict EN50160 monitoring only).....	6-20
 CHAPTER 7 - View Event Data	
Overview	7-1
Section A -Events.....	7-4
Overview	7-4
Event Data Display	7-5
Event Activity Graph.....	7-6
Event List.....	7-7
Event Detail	7-9
Event Options	7-12
Section B -Trend	7-15
Overview	7-15
Trend Display	7-16
Trend Setup.....	7-17
 CHAPTER 8 - Reports	
Overview	8-1
Section A -EN50160	8-2
Overview	8-2
EN50160 Measurement Parameters	8-3
EN50160 Compliance Limits	8-5
Compliance Statistical Bar Chart	8-8
Compliance History	8-11
Event Statistics.....	8-13
Min/Max Table for Power Frequency and RMS Voltage	8-15
Section B -Status Report in Annunciator Panel	8-16
Overview	8-16
Panel Setup Options.....	8-17
Panel Operation	8-19
 CHAPTER 9 - Downloading Events	
Overview	9-1
External Communication Interface.....	9-2
Downloading Events via NodeLink	9-10
Viewing Events via DranView	9-11
DranView with HASP	9-12

Table of Contents, Continued

APPENDIX A - Optional Accessories

Overview	A-1
Hardware Accessories List & Descriptions.....	A-2
Software Accessories List	A-8

APPENDIX B - Technical Specifications

Overview	B-1
General.....	B-2
Interfaces	B-3
Measured Parameters.....	B-4
Computed Parameters.....	B-5
Parameter Settings in Each Monitoring Mode	B-9
TR2500 Current Probe.....	B-11
TR2510 Current Probe.....	B-12

APPENDIX C - Battery Specifications and Replacement Procedure

Overview	C-1
Battery Specifications.....	C-2
Battery Pack Safety Precautions.....	C-3
Battery Pack Replacement.....	C-4

APPENDIX D - User Replaceable Parts List

APPENDIX E - Common Circuit Connections

Overview	E-1
Verifying Voltage and Current Connections.....	E-5
Single Phase.....	E-7
Split Phase	E-8
3 Phase, Four Wire Wye.....	E-9
3 Phase (Floating or Grounded) Delta.....	E-10
3 Phase 2-Watt Delta	E-11
Generic Circuit	E-12
2 1/2 Element Without Voltage Channel B.....	E-13
2 1/2 Element Without Voltage Channel C.....	E-14
Connecting to a Potential Transformer (PT)	E-15
Connecting to a Current Transformer (CT).....	E-17
Connecting to an Isolated Current Transformer (ISO).....	E-18

APPENDIX F - Event Classification

APPENDIX G - PowerVisa Menu Structure



PowerVisa™ MAVOWATT 30

(Dranetz-BMI PowerVisa™)



CHAPTER 1



Getting Started

Overview

PowerVisa description

The Dranetz-BMI PowerVisa™ is a portable, hand-held, eight-channel power quality meter/monitor. This cutting-edge power quality instrument is designed with a color liquid crystal display (LCD) 1/4 VGA, using touch screen technology. It can monitor, record and display data on four voltage channels and four current channels simultaneously.

The PowerVisa is designed to meet both the IEEE 1159 and IEC 61000-4-30 Class A standards for accuracy and measurement requirements. It can also monitor EN50160 compliance based on the EN (European) Standards. The statistical package called Quality of Supply (QOS) is built into the PowerVisa, with monitoring and setup protocols set to determine voltage measurement compliance required for EN50160 monitoring. European standard EN50160 requires that measurement parameters must be within a specified percentage for 95% of the time.

PowerVisa firmware

The firmware for the PowerVisa is contained on internal FLASH memory. It has an operating system capable of performing multiple applications. When an updated version of the firmware is released, the user can upgrade the internal program by putting the latest PowerVisa firmware program card in the appropriate slot of the mainframe. **See page 1-10 for instructions on how to upgrade the PowerVisa firmware from a data card.**

The PowerVisa firmware can monitor power quality phenomena for troubleshooting and/or compliance purposes. It can carry out long-term statistical studies to establish performance baselines, and perform field-based equipment testing and evaluation for commissioning and maintenance. The firmware integrates an intuitive instrument setup procedure to ensure the capture of all relevant data for additional post process analysis, report writing, and data archiving using other compatible Dranetz-BMI software applications such as NodeLink® and DranView®.

This manual

This manual contains instructions for operating the Dranetz-BMI PowerVisa.

In this chapter The following topics are covered in this chapter.

Topic	See Page
Unpacking the PowerVisa	1-3
Standard Accessories	1-4
PowerVisa Controls, Indicators and Connectors	1-5
Upgrading Firmware from a Data Card	1-10
PowerVisa Features	1-12
Basic Operation	1-14

Unpacking the PowerVisa

Introduction For maximum protection against possible shipping damage, the PowerVisa has been sealed in a two-piece, plastic suspension pack, enclosed within a durable shipping carton. After opening the carton, inspect the contents for possible shipping damage and check the carton inventory.

Unpacking Unpack the PowerVisa from the carton as follows:

Step	Action
1	Remove any remaining literature inside the top of the carton.
2	Carefully remove the PowerVisa from its shipping carton.
3	Remove all accessories inside the carton. Check that all of the standard accessories (see page 1-4) are included.

Shipping damage inspection Visually inspect the PowerVisa for possible shipping damage. If any damage exists, first notify and file an insurance claim with your carrier or underwriter or both. Then notify Dranetz-BMI Customer Service Department of your intentions to return the unit. DO NOT return the PowerVisa without prior instructions from Dranetz-BMI Customer Service Department. Dranetz-BMI Customer Service Department can be reached at (732) 287-3680 or 1-800-372-6832.

Repacking for return shipment If the unit must be returned to Dranetz-BMI for service or repair, wrap the unit securely in heavy packaging material and place in a well padded box or crate to prevent damage. Do not return the PowerVisa in an unpacked box. Dranetz-BMI will not be responsible for damage incurred during transit due to inadequate packing on your part.

Return notice Notify Dranetz-BMI Customer Service of your intention of returning the unit. Do not return the unit without prior instructions from Dranetz-BMI. Dranetz-BMI Customer Service Department can be reached at (732) 287-3680 or 1-800-372-6832.

Standard Accessories

Standard accessories

The following table lists the PowerVisa's standard accessories.

Description	Part Number
Cable Set	116042-G3
Easel	116038-G1
AC Adapter	117029-G1
*US Power Cord	USSTDCORD (900744)
*European Power Cord	EUROSTDCORD (115369-G2)
*United Kingdom Power Cord	UKSTDCORD (115368-G2)
*Australian Power Cord	AUSTDCORD (901347)
Notice: Charge Battery	899117
*User specified, one standard only.	

Optional accessories

Refer to Appendix A for the list of hardware and software optional accessories available for use with PowerVisa.

Batteries

Refer to Appendix C for the description and replacement of the batteries contained in PowerVisa.

Replaceable parts

Refer to Appendix D for the user replaceable parts.

Calibration

The recommended calibration interval for this unit is once every 12 months.

We recommend that you return the unit to the factory for calibration. If you decide to do so, first contact the Dranetz-BMI Customer Service Department to obtain an Authorization Number.

Telephone: (732) 287-3680 or 1-800-372-6832
FAX: (732) 248-9240

Fill out the Repair/Service Order form enclosed in the shipping carton and ship it along with the unit to the Dranetz-BMI Repair Department. (If this form is missing, ask the Dranetz-BMI Customer Service Department for a replacement.)

PowerVisa Controls, Indicators, and Connectors

Dimensions

PowerVisa is a self-contained, portable instrument weighing less than 4 pounds and measuring 8" (20.3 cm) deep by 12" (30.5 cm) wide by 2.5" (6.4 cm) high. This section identifies and describes the controls, indicators, and connectors on all panels of the PowerVisa shown with rubber boot installed.

Top View

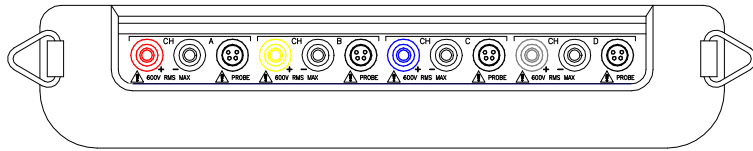

Front View



Rear View

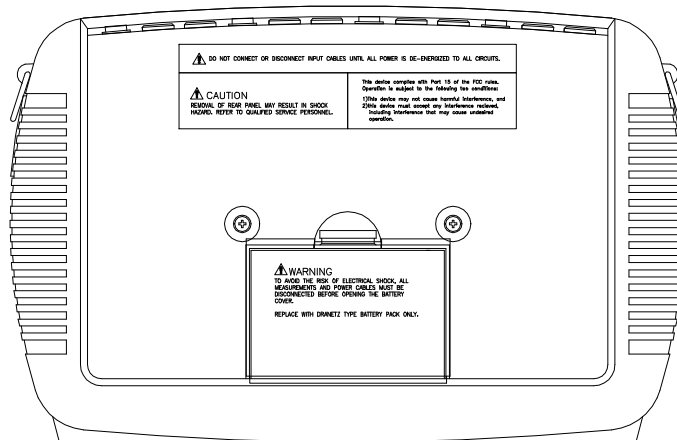

Bottom View

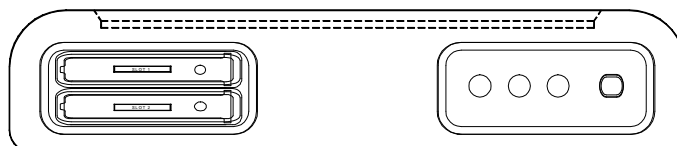

Top and Side views

The top (circuit connection) view features the input voltage and current connectors. The left side contains the optical interface port. The right side contains the AC adapter input connector. Both sides have rings for attaching the supplied carrying strap. See below for descriptions of the top and side connectors.

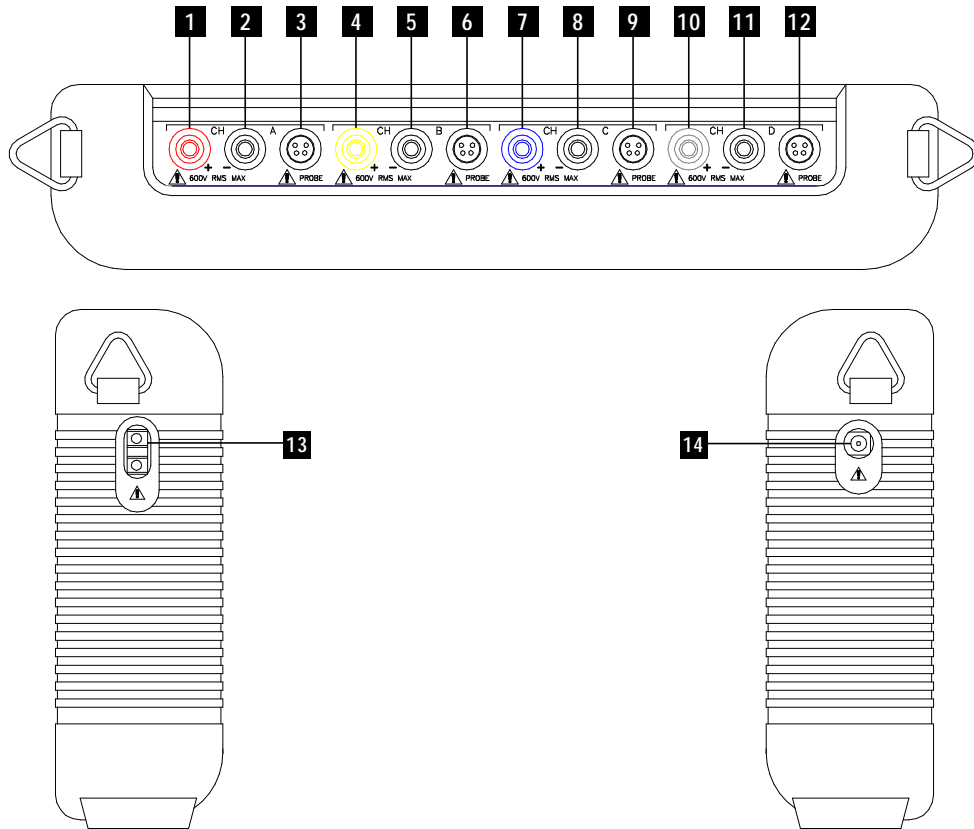

Parts table

Part	Function
1	CH A, + Differential Voltage Input Connector; color red.
2	CH A, - Differential Voltage Input Connector; color white.
3	CH A, PROBE, Current Input Connector.
4	CH B, + Differential Voltage Input Connector; color yellow.
5	CH B, - Differential Voltage Input Connector; color white.
6	CH B, PROBE, Current Input Connector.
7	CH C, + Differential Voltage Input Connector; color blue.
8	CH C, - Differential Voltage Input Connector; color white.
9	CH C, PROBE, Current Input Connector.
10	CH D, + Differential Voltage Input Connector; color grey.
11	CH D, - Differential Voltage Input Connector; color white.
12	CH D, PROBE, Current Input Connector.
13	Optical Serial Data Port
14	AC Adapter/Battery Charger Input Connector.

Front view

The front view primarily shows the color touch screen LCD. See below for descriptions of the PowerVisa front panel.

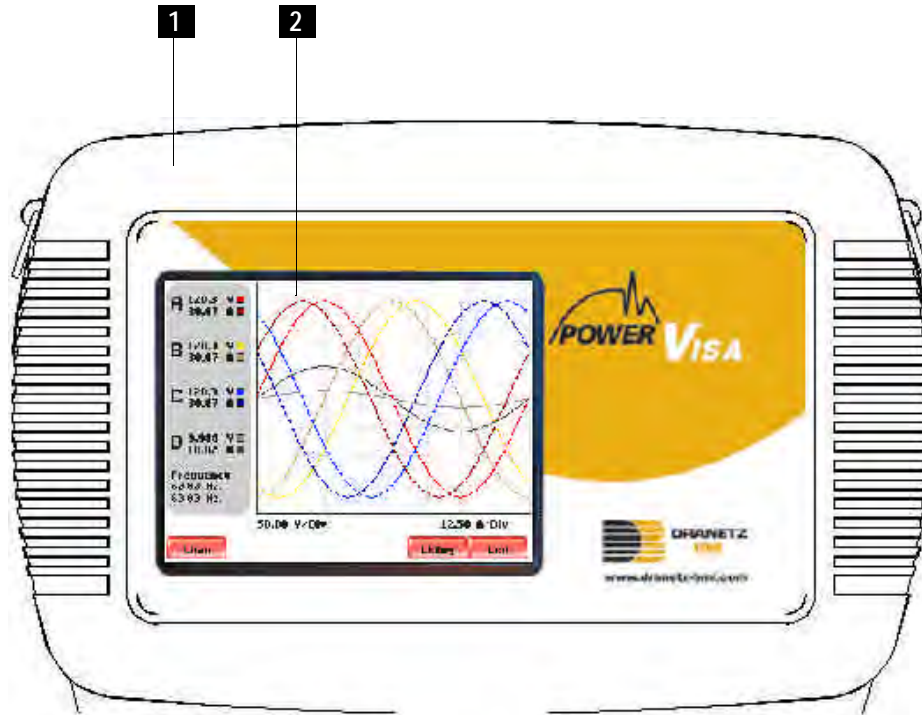
**Parts table**

Part	Function
1	Mainframe Protective Rubber Boot Enclosure
2	<p>Liquid Crystal Display (LCD). Provides 3.75 x 4.75 inches display consisting of 1/4 VGA size screen of text and graphic information. The color LCD is equipped with touch screen technology, operable using the finger and/or PDA stylus. Touch screen display permits menu selection, alphanumeric data entry, and has a compact fluorescent (CCFL) backlighting that is always on for low light level viewing.</p> <p><u>The following are some basic care instructions for the LCD monitor:</u></p> <ul style="list-style-type: none"> • Use and store the unit within the specified temperature and humidity range. The LCD screen may be adversely affected by exposure to high temperature or humidity. Condensation or moisture produced by sudden temperature changes may also damage the LCD screen. Clean any moisture from surface immediately. • Be careful when cleaning or removing stains on the LCD surface. Gently wipe the surface with a soft cloth or cotton pad. Isopropyl alcohol may be used, but make sure that all solvent residue is removed. • Do not apply excessive force to the LCD surface. The LCD screen contains sensitive electronic components that may be damaged due to strong impact.

Bottom view

The bottom view features two slots. Either slot can be used to hold the data card.
 NOTE: Use only one card slot (one data card) at a time. The additional slot will be used for future communications options.

The bottom also features LED indicators and the On/Off power button. See below for descriptions of the slots, indicators, and button.

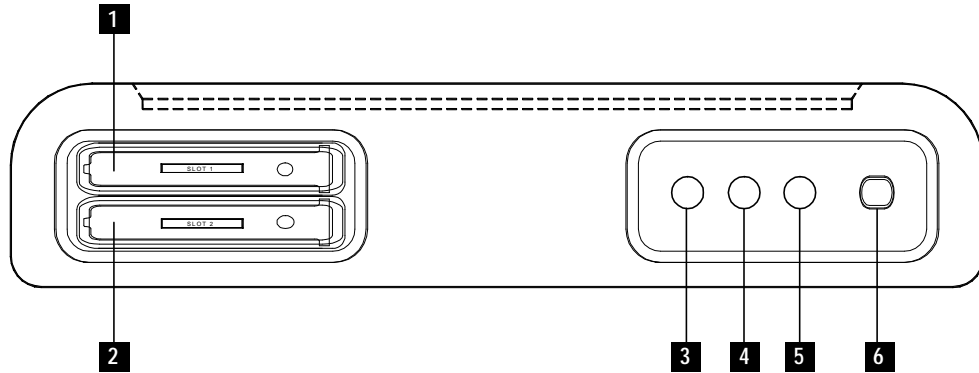

Parts table

Part	Function
1	Slot 1. Holds and connects data card to internal circuitry. Data card works in either Slot 1 or Slot 2. Eject data card by pushing data card release.
2	Slot 2. Holds and connects data card to internal circuitry. Data card works in either Slot 1 or Slot 2. Eject data card by pushing data card release. NOTE: This additional slot will be used for future options.
3	Battery Charge Indicator. LED will light steadily while battery is fast charging and blink when fully charged.
4	Status Indicator. LED will light steadily when abnormal condition is detected. The unit is operating normally when light is off.
5	Power Indicator. LED will blink in a heartbeat fashion (once per second) when the unit is operating normally.
6	On/Off Power Button. Push for on, push for off.

Rear view

The rear view shows the battery compartment and the easel studs to mount the unit to desired angular position for use on a flat surface or to hang from a panel.

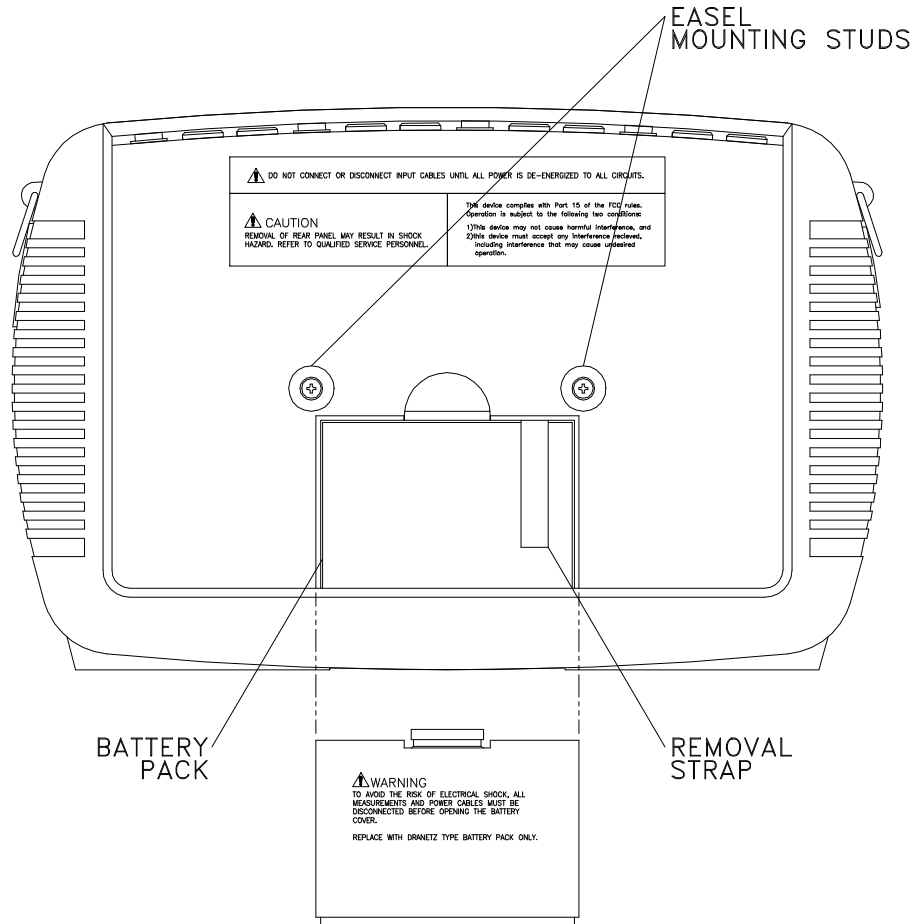

Upgrading Firmware from a Data Card

PowerVisa firmware web upgrade

Users can upgrade the PowerVisa internal program by downloading the latest firmware update release from the web and installing it into the PowerVisa internal memory. Refer to the instructions below on how to upgrade the PowerVisa firmware.

Firmware upgrades for the PowerVisa can be downloaded from the Dranetz-BMI website. Log on to www.dranetz-bmi.com for the latest information on PowerVisa firmware update releases.

Copy firmware program in data card

The procedure below specifies how to download the latest PowerVisa firmware from the web and copy it into a data card.

Step	Action
1	Locate the latest version of the firmware upgrade (in data file format “hostcode.bin”) from the Dranetz-BMI website www.dranetz-bmi.com . Dranetz-BMI regularly posts the latest information and instructions regarding PowerVisa firmware upgrade releases.
2	Format the Compact Flash data card using the Memory Card options in PowerVisa. The card must be formatted before it can be written to. Refer to Chapter 5 Start Menu - Site Name/Memory Card on page 5-21 for instructions on how to format data card. NOTE: All data and setups stored in card will be lost when you format the data card. Copy any files that you want to save to a computer first before formatting card.
3	Insert the Compact Flash data card into the appropriate slot in the computer. If the computer does not accommodate a Compact Flash card in its native format, use a compatible PC card adapter to be able to read/write data into the card.
4	Download and copy the latest version of the PowerVisa firmware upgrade program (data file “hostcode.bin”) from the Dranetz-BMI website to the data card. Refer to page 1-11 for instructions on how to install the data card containing the latest firmware upgrade to the PowerVisa.

Install data card to PowerVisa The procedure below specifies how to install the data card containing the latest firmware upgrade to the PowerVisa.

Step	Action
1	Make sure that the unit is off. If not, press the PowerVisa On/Off power button to turn unit off.
2	Remove the data card from its protective holder and check that the plug end of card is clean and free of any obstruction. NOTE: If plug end of card is dirty, clean with static-free, dry, low pressure air to remove any foreign material causing obstruction of the plug holes.
3	At the bottom of the unit, position the data card with the label facing up and the plug end facing the top slot (Data Card Slot 1). Make sure that there are no other cards in the unit except for the data card.
4	Insert the card fully into the top slot (Data Card Slot 1) until resistance is felt, then press firmly until the card engagement is felt. NOTE: Do not force the card further into the slot if no card engagement is felt. Remove card and check if there is foreign object on or in the plug end of the card. Remove any obstruction. Reinsert program card and repeat card engagement. If card cannot be engaged, STOP all further action and call Dranetz-BMI Technical Support at 1-800-372-6832 for assistance.
5	Turn the unit on by pushing the on/off button. The loader should display “Booting from program card”. If not, call Dranetz-BMI Technical Support for assistance.
6	The instrument will prompt the user to verify whether or not to upgrade the firmware. Press Yes and the upgrade procedure will commence. Do not turn the power off nor remove the data card while firmware upgrade is in progress.
7	If no errors were detected, a window displaying “Installation Complete” will pop up. Remove the data card from the unit.

PowerVisa Features

Touch screen function	All PowerVisa functions described below are operable using a color LCD touch screen technology. Users may use a finger and/or a PDA stylus to apply pressure to the LCD screen to result in touch screen recognition. The touch screen display is also workable with lineman gloves on. Touch screen buttons will appear in reverse-video to show visual feedback of contact along with audible feedback. In order to reduce power consumption, the backlight of the LCD screen times-out after a specified programmable time of no user activity. The backlight reactivates by touching any part of the screen.
Scope mode	Scope mode functions as an oscilloscope, displaying real-time waveforms of voltage and current for up to eight channels simultaneously, with one second update rate. The colors of waveform display are user programmable. Scope mode also provides a textual display of rms values, division for axis values, and frequency.
Meter mode	Meter mode functions as a true rms voltmeter and a true rms clamp-on ammeter. Voltage and current measurements, along with other calculated parameters, are displayed on the Meter mode screens in both textual and graphical format.
Harmonics	Harmonics display the amplitude and phase of each harmonic to the 63rd harmonic in both graphical and textual format.
Phasor diagram	The phasor screen displays a graph that indicates phase relations between voltage and current based upon the angles at the fundamental frequency, as determined by Fourier analysis. Phasor diagram displays voltage and current phasors for all channels. Functioning as a phase angle meter, the unit can display system imbalance conditions and provides such information in textual form also. The phase angle display can also verify if monitoring connections have been made correctly. Animated phasor demo rotations demonstrating resistive, inductive and capacitive loads can be displayed.
Flicker	Flicker is a phenomenon due primarily to rapid small fluctuations of the voltage. Loads that exhibit continuous, rapid variations in the load current, particularly the reactive component, can cause voltage variations often referred to as flicker. Flicker is characterized by modulation at a frequency typically less than 25 Hz. Modulating signal magnitudes as low as 0.5% of the fundamental for frequencies between 5-10 Hz can result in perceptible light flicker.
Event	An event occurs when a programmed threshold limit is crossed. An event consists of the pre-trigger cycle(s), trigger cycle(s), and post-trigger cycle(s).

Continued on next page

Monitoring capacity

The PowerVisa can monitor the following power configurations:

- Single Phase
- Split Phase
- 3 Phase Delta
- 3 Phase Wye
- 3 Phase 2-Watt Meter Delta
- Generic
- 2 1/2 Element without V_B
- 2 1/2 Element without V_C

While monitoring any of the above configurations, the PowerVisa can also be connected to monitor neutral to ground voltage and neutral or ground current.

Automatic setup, Wizard setup, or Advanced setup

Setup is a configuration of parameter thresholds that control the data recorded by the PowerVisa. Users may perform instrument setup in three ways: via Automatic Setup which utilizes auto-configured settings and allows users to proceed directly with data monitoring; via Wizard Setup which follows a step-by-step sequence where users go through a series of circuit setup screens; or via Advanced setup which allows users to modify trigger parameters and intervals or tweak threshold settings under the Advanced Options.

Trend

Users can generate plots for all journalled data combined with min/max recordings of that parameter. Most journal parameters have multiple channels to plot.

Reports

Users have two options on how to view QOS compliance reports.

EN50160 displays statistical reports on QOS compliance based on an analysis of the voltage as per requirements of the EN50160 standard. Compliance data is presented in bar charts, statistical tables, and graphs. Statistical data is calculated on the required parameters specified in EN50160 over one week interval to produce a PASS/FAIL decision of QOS compliance.

Status presents a report summary for Standard PQ, EN50160, and Motor Quality parameters via the annunciator panel. The panel is color coded such that green indicates the parameter is within limits, yellow means it is moderately out of limits, while red signifies it is severely out of limits. Unlike the EN50160 which reports on QOS compliance on a weekly basis, Status monitors compliance continuously. There is also the option to view a parameter in more detail i.e. display its data plot, threshold values, or edit parameter/channel settings.

Data Card

PowerVisa supports the use of Compact Flash data cards with AT LEAST 32MB storage capacity. The user replaceable data card is used as primary storage for data. Data monitoring CANNOT proceed without the data card. The PowerVisa is designed to accommodate the Compact Flash card in its native format, and does not require the use of a PC card adapter. However, a PC card adapter can be used to read the data into a laptop or other computer with a PC card slot.

Basic Operation

Introduction The normal power source for the PowerVisa is its internal battery pack. The AC Adapter/Battery Charger is used to charge the battery. Always charge the battery fully before use. The PowerVisa will always operate on the charger and is designed to do so, regardless of the state of charge of the battery.

Battery pack Type: Sealed, rechargeable NiMH (Nickel Metal Hydride) cells.

Length of operation: The PowerVisa can operate on a fully charged battery pack for more than two (2) hours with the backlight on. When the backlight is turned off, the unit can operate for more than three (3) hours. For information on how to turn backlight on or off, see Chapter 4 Instrument Settings - Set Display Preferences on page 4-6.

Charging: The battery pack can be charged by connecting the AC Adapter/Battery Charger to the PowerVisa. A screen warning will appear during operation when battery charge is low. A depleted battery pack can be recharged in six (6) hours whether the unit is on or off. The Battery Charge Indicator glows steadily while charging, and flashes when fully charged.

NOTE: The Battery Charge Indicator functions whenever the AC Adapter/Battery Charger is properly connected.

AC power source The PowerVisa can be operated from a 50/60 Hz 120/230V AC power source with or without the battery pack installed.

Connect the AC Adapter output cable to the Input Connector on the right side of the PowerVisa. Connect the AC Adapter power cord to an appropriate outlet.

Refer to Appendix C for the specifications and replacement of the batteries contained in PowerVisa.

Power on sequence

Follow these steps to turn on the PowerVisa and display the Home screen.

Step	Action
1	Connect ac adapter/battery charger plug into the right side of PowerVisa.
2	Plug the ac adapter into an ac power source.
3	Press the PowerVisa On/Off power button to turn the unit on. <u>Result:</u> The Home screen will be displayed.

PVISA001

Home screen features

Home screen is frequently referenced as the starting point for all major functionalities of the PowerVisa.

The date and time appear on the top right corner of the Home screen. Both can be configured to appear in a different format. See page 4-3 for the procedure on how to set and reformat time and date.

The unit name and model, PowerVisa program revision level, and status messages appear in the upper portion of the Home screen. Pertinent information that appear in the status message area are the monitoring status, circuit configuration, percentage of data card used while monitoring, site/file name, number of event cycles saved, and number of timed intervals saved.

MONITORING STATUS: OFF indicates that the instrument is not actively monitoring data. The monitoring status message will change to ON, DONE or ARMED, depending upon the state of data monitoring. See page 5-25 for the procedure on how to turn monitoring on/off.

Home screen contains the icons used to access the various PowerVisa functions. See page 1-16 for the description of each icon found in Home screen.

Home screen icons

Home screen contains the following icons used to access various PowerVisa functions:

Scope - Scope mode shows real-time voltage and current waveforms of the signals on the measuring inputs. See Chapter 3 View Real Time Data - Section A Scope Mode.

Meter - Meter mode displays voltage and current measurements, along with other calculated parameters. See Chapter 3 View Real Time Data - Section B Meter Mode.

Harmonics - Harmonic screen displays a spectral graph and textual matrix featuring the amplitude and phase of each voltage and current harmonic to the 63rd harmonic. See Chapter 3 View Real Time Data - Section C Harmonics.

Phasor - Phasor diagrams indicate phase relations between voltage and current based upon the angles of the fundamental. See Chapter 3 View Real Time Data - Section D Voltage and Current Phasor.

Preferences - Users can set instrument preferences like time and date, threshold alarm feedback, language selection, communications, LCD display, and data card operation. See Chapter 4 Instrument Settings.

Events - Events result in a contiguous collection of cycles that is recorded into memory. Events are classified according to IEEE 1159, IEC 61000-4-30 Class A, and EN50160 standards. Events are displayed only after monitoring has been turned on or upon reading a stored file from the data card. See Chapter 7 View Event Data - Section A Events.

Trend - Trend allows users to view plots of journalled data along with min/max measurements over the interval. See Chapter 7 View Event Data - Section B Trend.

Reports - The PowerVisa allows users to view two types of reports on QOS compliance. EN50160 reports show graphs and statistical tables reflecting the compliance of parameters specified according to EN50160 standard. Status shows a quick status summary of Standard PQ, EN50160, and Motor Quality parameters using the annunciator panel. The color coded panel indicates whether or not a parameter is within limits. See Chapter 8 Reports.

Start/Setup - Users have the option to use Automatic Setup and proceed directly with data monitoring or they can configure the instrument step-by-step using the Wizard Setup. Users can also do Advanced setups to modify trigger parameters and intervals or tweak threshold settings under the Advanced Setup Options. See Chapter 5 Start Menu and Chapter 6 Advanced Setup Options.

CHAPTER 2



Voltage Measurement Cable and Current Probe Connections

Overview

Introduction This section describes how to connect the PowerVisa to make basic single phase voltage measurements. For multi-phase connection diagrams, refer to Appendix E.

In this chapter The following topics are covered in this chapter.

Topic	See Page
Connecting Voltage Measurement Cables	2-4
Connecting Current Probes	2-9

WARNING **Death, serious injury, or fire hazard could result from improper connection of this instrument. Read and understand this manual before connecting this instrument. Follow all installation and operating instructions while using this instrument.**

Connection of this instrument must be performed in compliance with the National Electrical Code (ANSI/NFPA 70-2005) and any additional safety requirements applicable to your installation.

Installation, operation, and maintenance of this instrument must be performed by qualified personnel only. The National Electrical Code defines a qualified person as “one who has the skills and knowledge related to the construction and operation of the electrical equipment and installations, and who has received safety training on the hazards involved.”

Qualified personnel who work on or near exposed energized electrical conductors must follow applicable safety related work practices and procedures including appropriate personal protective equipment in compliance with the Standard for Electrical Safety Requirements for Employee Workplaces (ANSI/NFPA 70E-2000) of USA and any additional workplace safety requirements applicable to your installation.

Continued on next page

ADVERTENCIA Una conexión incorrecta de este instrumento puede producir la muerte, lesiones graves y riesgo de incendio. Lea y entienda este manual antes de conectar. Observe todas las instrucciones de instalación y operación durante el uso de este instrumento.

La conexión de este instrumento debe ser hecha de acuerdo con las normas del Código Eléctrico Nacional (ANSI/NFPA 70-2005) de EE. UU., además de cualquier otra norma de seguridad correspondiente a su establecimiento.

La instalación, operación y mantenimiento de este instrumento debe ser realizada por personal calificado solamente. El Código Eléctrico Nacional define a una persona calificada como "una que esté familiarizada con la construcción y operación del equipo y con los riesgos involucrados."

AVERTISSEMENT Si l'instrument est mal connecté, la mort, des blessures graves, ou un danger d'incendie peuvent s'en suivre. Lisez attentivement ce manuel avant de connecter l'instrument. Lorsque vous utilisez l'instrument, suivez toutes les instructions d'installation et de service.

Cet instrument doit être connecté conformément au National Electrical Code (ANSI/NFPA 70-2005) des Etats-Unis et à toutes les exigences de sécurité applicables à votre installation.

Cet instrument doit être installé, utilisé et entretenu uniquement par un personnel qualifié. Selon le National Electrical Code, une personne est qualifiée si "elle connaît bien la construction et l'utilisation de l'équipement, ainsi que les dangers que cela implique".

WARNUNG Der falsche Anschluß dieses Gerätes kann Tod, schwere Verletzungen oder Feuer verursachen. Bevor Sie dieses Instrument anschließen, müssen Sie die Anleitung lesen und verstanden haben. Bei der Verwendung dieses Instruments müssen alle Installation- und Betriebsanweisungen beachtet werden.

Der Anschluß dieses Instruments muß in Übereinstimmung mit den nationalen Bestimmungen für Elektrizität (ANSI/NFPA 70-2005) der Vereinigten Staaten, sowie allen weiteren, in Ihrem Fall anwendbaren Sicherheitsbestimmungen, vorgenommen werden.

Installation, Betrieb und Wartung dieses Instruments dürfen nur von Fachpersonal durchgeführt werden. In dem nationalen Bestimmungen für Elektrizität wird ein Fachmann als eine Person bezeichnet, welche "mit der Bauweise und dem Betrieb des Gerätes sowie den dazugehörigen Gefahren vertraut ist."

Safety precautions

The following safety precautions must be followed whenever any type of voltage or current connection is being made to the PowerVisa.

- Wear proper Personal Protective Equipment, including safety glasses and insulated gloves when making connections to power circuits.
- Hands, shoes and floor must be dry when making any connection to a power line.
- Before each use, inspect all cables for breaks or cracks in the insulation. Replace immediately if defective.
- Set the PowerVisa power switch to Off.
- Before connecting to electric circuits to be monitored, open their related circuit breakers or disconnects. DO NOT install any connection of the PowerVisa to live power lines.
- Connections must be made to the PowerVisa first, then connect to the circuit to be monitored.

Continued on next page

Connecting Voltage Measurement Cables

Measurement cable set

Description: Voltage measurement cables are provided as standard accessories and are stored in a cable pouch as part of the measurement cable set, P/N 116042-G3. Each cable set consists of a cable and alligator clip.

Voltage Rating: Direct connection of all voltage measurement cables are rated at 600 Vrms max. For measuring voltages greater than 600 Vrms, potential transformers (PTs) must be used.

Contents: The voltage measurement cables are shown on page 2-5 (positioned relative to their actual use). A cable set consists of eight, 6-foot channel measurement cable assemblies (probes), each with a detachable, alligator jaw, safety clip assembly (maximum jaw opening, 3/4 in (20 mm)). The safety clip assemblies are red (+) and black (-) for each of the four channels. One cable each of red (channel A), yellow (channel B), blue (channel C), and grey (channel D), and four each of white are provided.

A pouch for storage of the cables and the AC adapter/battery charger is included in the contents of the measurement cable set, but is not shown in the figure.

Optional fused voltage adapter

There are two optional fuse accessory kits available for use with the measurement cables. One kit (P/N FVA-1) contains one fused voltage adapter and one measurement connecting Red cable 50 cm in length. The other kit (P/N FVA-4) contains four voltage adapters and four measurement connecting cables 50 cm in length (one Red, one Yellow, one Blue, and one Grey).

The single fuse voltage adapter kit is used for one single voltage measurement input. While the four fuse voltage adapter kit is used for a three phase and neutral voltage measurement inputs.

Continued on next page

Measurement cable set with optional fuse diagram

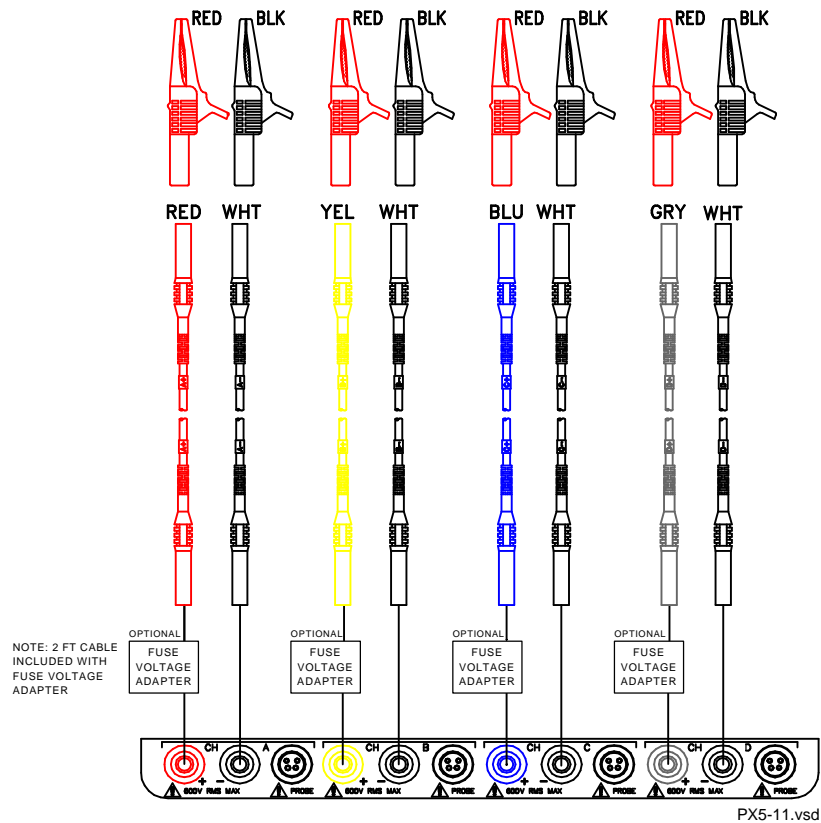

WARNING To avoid the risk of electric shock or burns, always connect the safety (or earth) ground before making any other connections.

WARNING To reduce the risk of fire, electrical shock, or physical injury it is strongly recommended to fuse the voltage measurement inputs. Fuses must be located as close to the load as possible to maximize protection.

WARNING For continued protection against risk of fire or shock hazard replace only with same type and rating of recommended fuse. Use only fast blow type fuse which is rated 600V. Recommended fuse type is Littelfuse, part number KLKD0.30 rated 600V AC/DC, 0.3A fast blow.

WARNING Do not replace fuse again if failure is repeated. Repeated failure indicates a defective condition that will not clear with replacement of the fuse. Refer condition to a qualified technician.

Contact Dranetz-BMI Customer Service for more information on the fused voltage adapter. Refer to Dranetz-BMI Information Sheet titled Model FVA - Fuse Voltage Adapter, P/N 899107.

Connection guidelines

Follow these guidelines when making voltage connections.

- Refer to the measurement cable set figure for color coding of probes that connect to input channel connectors A, B, C, and D.
- Each channel input has plus (+) and minus (-) differential inputs of 1 to 600 Vrms max.

Example: Single phase connection

The following figure shows a voltage connection to a single phase circuit for channel A.

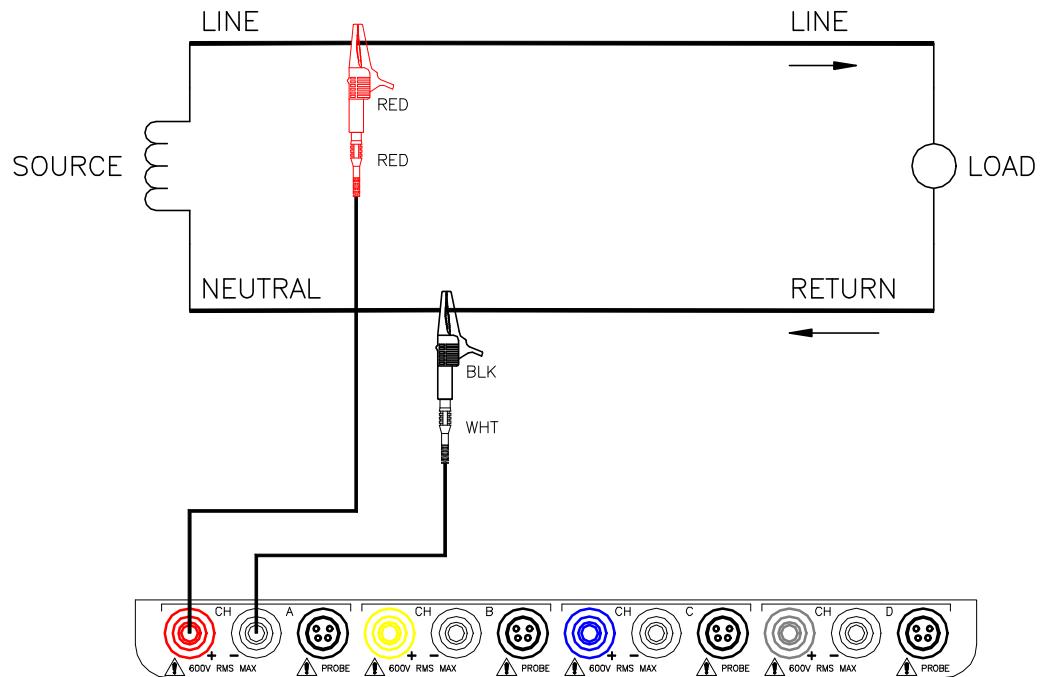

PX5-12.vsd

Continued on next page

**Example:
Neutral to
ground
connection**

The following figure shows a voltage connection using channel D as a differential input for measuring neutral to ground voltage. Connections are identical for split phase and wye configurations. One probe connects the source neutral line to the D+ input. Another probe connects the ground to the D- input.

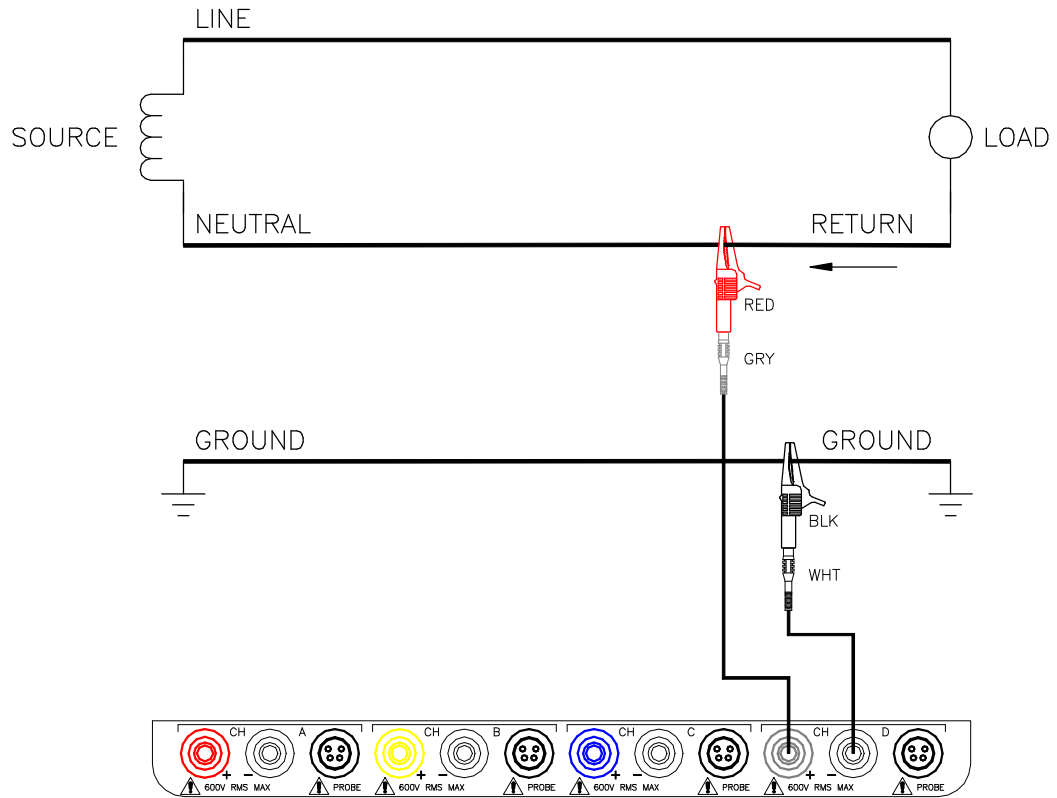

PX5-13.vsd

Safety precautions

The following safety precautions apply to current probe connections in addition to those safety precautions stated on page 2-3.

- DO NOT attempt to measure current in any circuit in which the circuit to ground voltage exceeds the insulation rating of the current probe (600 Vrms max).
- Make sure the jaws of the current probe are tightly closed. Keep mating surfaces clean and free from foreign matter.

WARNING

DO NOT USE non-insulated current probe cores around a non-insulated wire. Probes of this type are designed for use around insulated wires only. Use only completely insulated probe cores with no exposed conductive areas of the core around non-insulated wires.

ADVERTENCIA

NO UTILIZAR transformadores de corriente sin material aislante al rededor de conductores sin material aislante. Los Transformadores de corriente de este tipo están diseñados para ser utilizados solamente con conductores con aislamiento eléctrico. Utilizar transformadores de corriente completamente aislados alrededor de conductores sin aislamiento.

AVERTISSEMENT

N'EMPLOYEZ PAS les noyaux courants non-isolés de sonde autour d'un fil non-isolé. Des sondes de ce type sont concues pour l'usage autour des fils isolés seulement. L'utilisation seulement a complètement isolé des noyaux de sonde sans des secteurs conducteurs exposés du noyau autour des fils non-isolés.

WARNUNG

VERWENDEN Sie keine Stromzangen mit nicht isolierten Ferritkernen bei Messungen an nicht isolierten Leitungen. Stromzangen dieses Typs sind nur für Messungen an isolierten Leitern geeignet. Bitte verwenden Sie zur Messung an nicht isolierten Leitungen Stromzangen mit vollständig isoliertem Kernmaterial.

Continued on next page

Connecting Current Probes

Current probes Several Dranetz-BMI current probes can be used with the PowerVisa. Typical current probes are illustrated on page 2-10. Refer to Appendix A for descriptions and part numbers of probes and adapter cables. Refer to Appendix B for specifications of current probe models TR2500 and TR2510.

NOTE: The TR2500 can perform all current measurements except high frequency transient detection.

Probe positioning: An arrow marking on the handle is a guide to ensure that you position the probe with the arrow pointing towards the load when monitoring the line conductor. Correct position of the probe is necessary for correct power measurements, where in-phase voltage and current measurements are necessary. A positive watts reading indicates that the probe is pointed towards the load. A negative reading indicates that the probe is pointed towards the source.

Continued on next page

Typical current probes

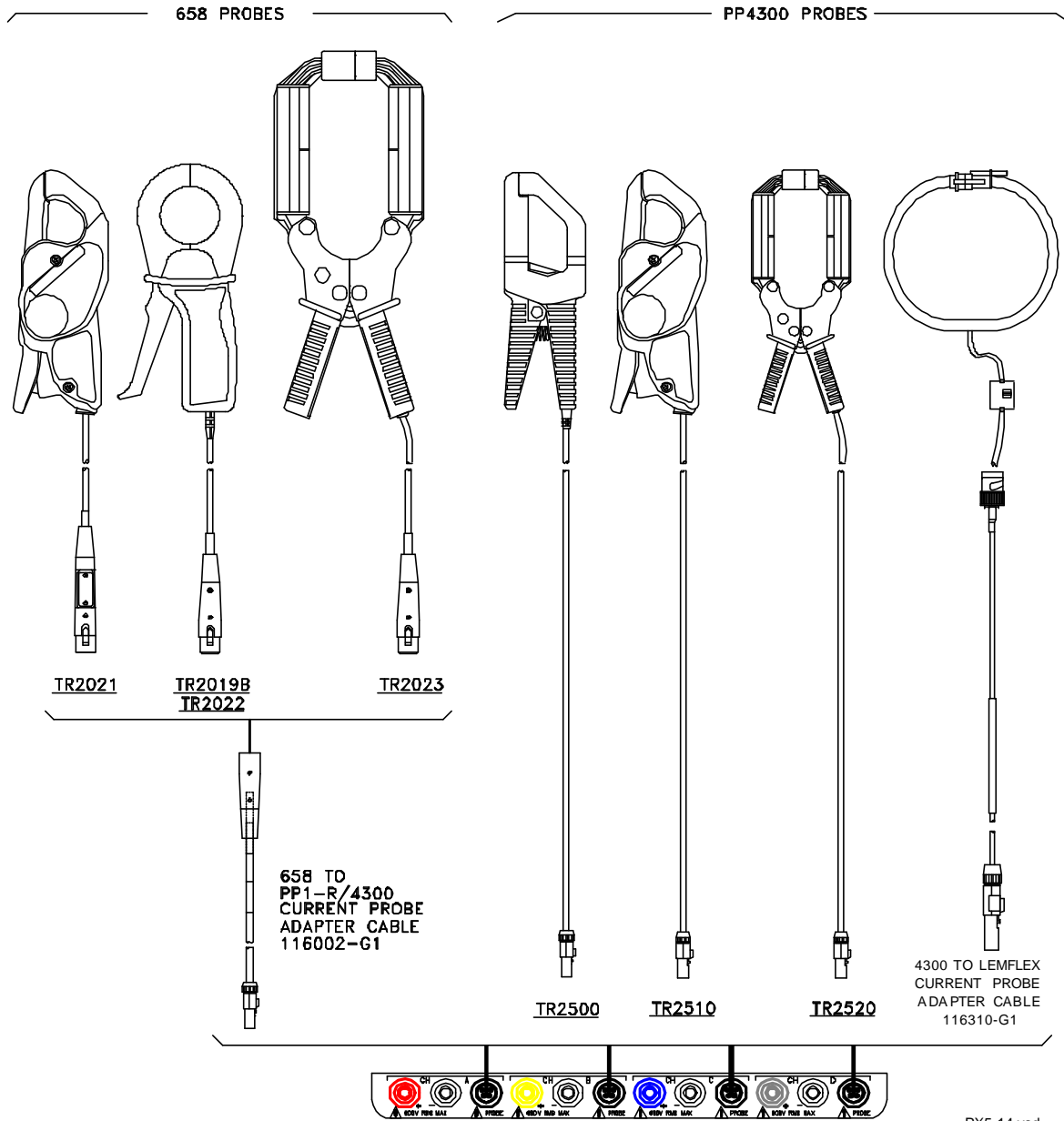

PX5-14.vsd

NOTE: Current probes TR2500 can be used interchangeably with TR2500A, TR2510 with TR2510A, and TR2520 with TR2520A.

Continued on next page

Typical current probes (continued)

Actual photos of TR series probes and part numbers are shown below to aid users in probe identification. Contact Dranetz-BMI Customer Service Department for more information on current probes, pricing and availability.



P/N TR-2500



P/N TR-2510



P/N TR-2520



P/N TR-2500A



P/N TR-2510A



P/N TR-2520A

Continued on next page

Single phase current probe connection example

The following figure shows how to connect a current probe to channel A for current monitoring of a single phase line.

The current probe may be connected to the return line if desired to measure the return current when checking for load current leakage, loop current relationships, etc. If measuring power, position the probe with the arrow pointing towards the load.

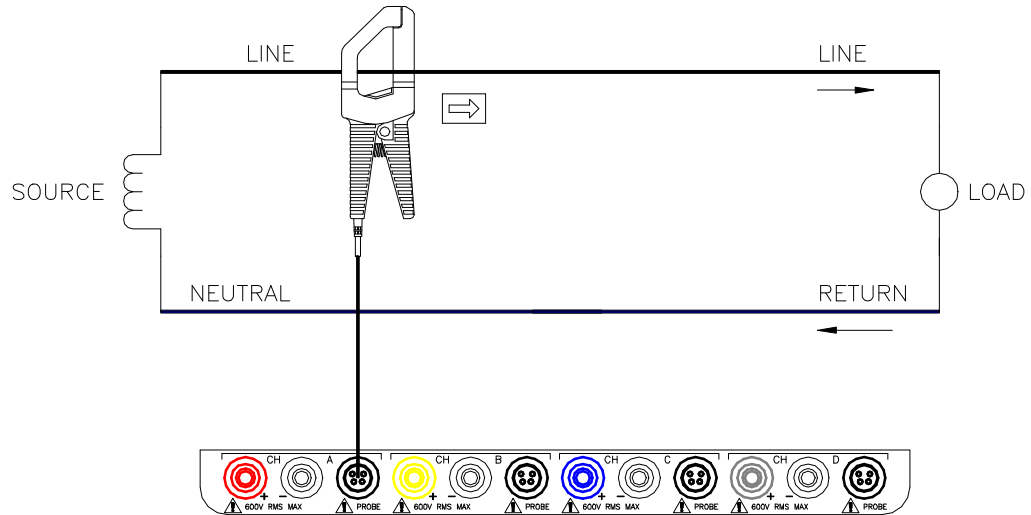

NOTE: The connection shown above is not recommended without a voltage connection to ensure frequency synchronization. If this configuration is used, then an internal frequency reference must be entered. Refer to pages 5-13 to 5-15.

CHAPTER 3



View Real Time Data

Overview

Introduction

The PowerVisa allows users to view power quality phenomena as it happens, when it happens. The instrument is able to capture and process data in real time, and allows users to view it in Scope mode, Meter mode, Harmonics, and Phasor display.

Access to real time data

Icons for Scope mode, Meter mode, Harmonics and Phasor display are available in the Home screen. Follow these steps to display the Home screen.

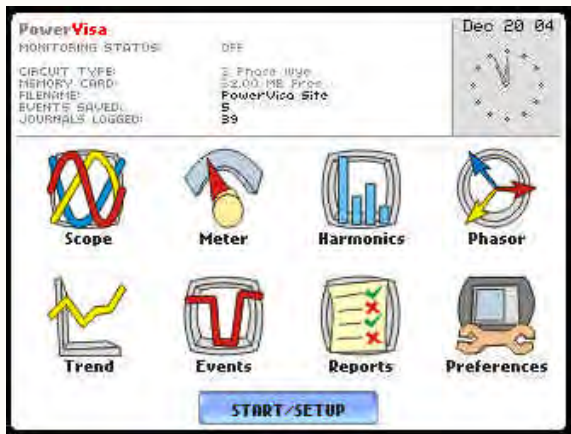
Action...	Result...
STEP 1: Press the PowerVisa On/Off power button to turn the unit on. The Home screen will be displayed.	

In this chapter

This chapter is divided into four sections.

Section	Title	See Page
A	Scope Mode	3-2
B	Meter Mode	3-5
C	Harmonics	3-10
D	Voltage and Current Phasor	3-15

Section A

Scope Mode

Overview

Introduction Scope mode allows you to view real-time voltage and current waveforms for up to eight channels simultaneously.

Scope mode screen The Scope mode screen can be displayed by pressing the Scope key on the Home screen.

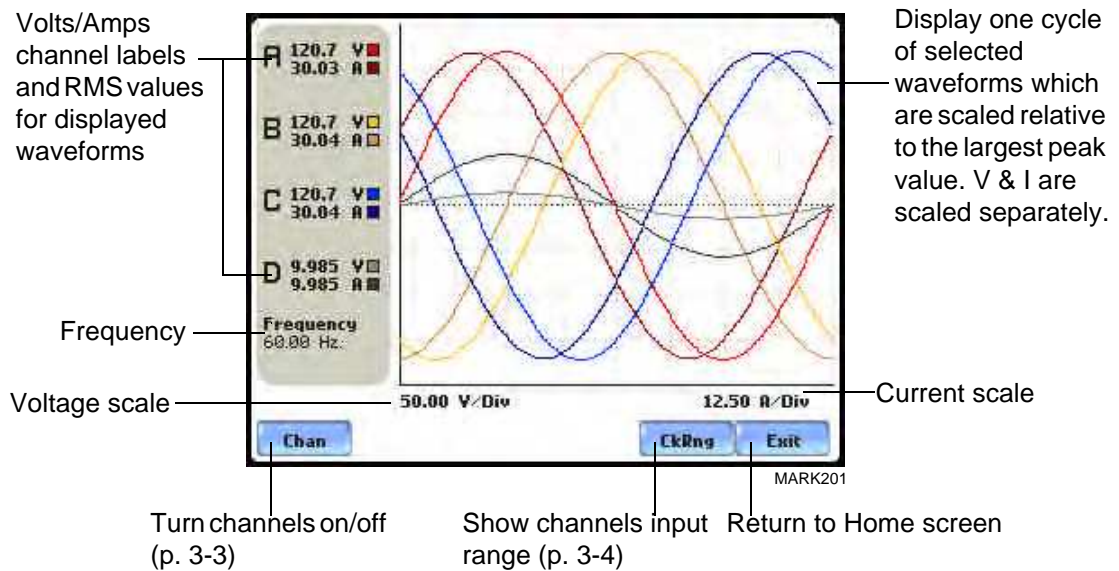

In this section The following topics are covered in this section.

Topic	See Page
Turning Channels On/Off	3-3
Checking Input Range	3-4

Turning Channels On/Off

Select channels to display From the Scope mode screen, press Chan to turn Volts/Amps channel selection on/off.

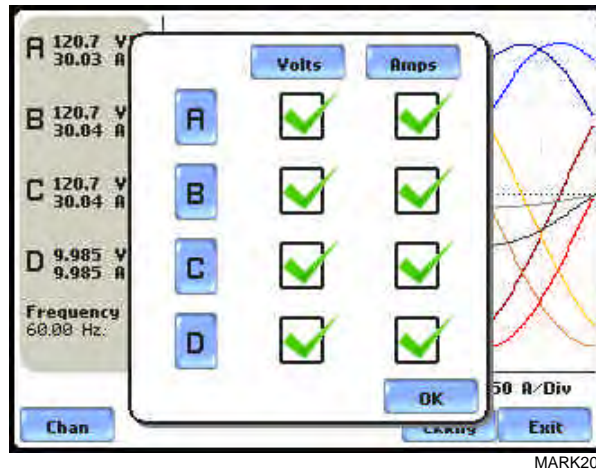

Any of the following will turn channels on/off:

- Press the desired Volts/Amps channel to turn it on/off.
- Press Volts or Amps button to turn on/off all channels of that parameter.
- Press A, B, C, D to turn on/off both the Volts and Amps for that channel.

Press OK to accept channel selection.

Checking Input Range

Input range

The Input Range screen is displayed by pressing the CkRng key on the Scope mode screen. Input Range shows the detected range for all channels. The number after the status shows the percentage of the input of the instrument's full range.

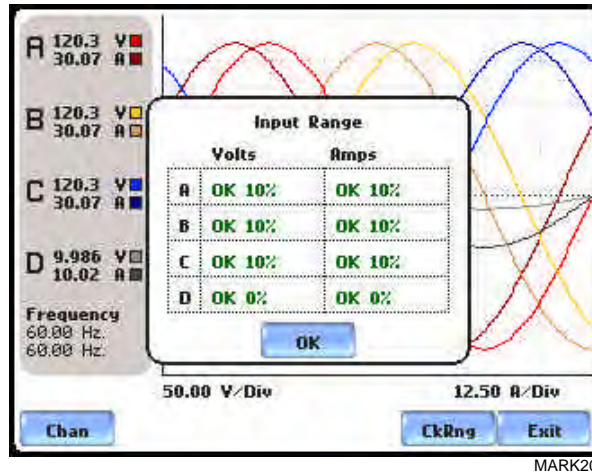

MARK205

The input range can only be viewed, not changed. Press OK when done viewing the input range.

Input range description

The following table describes the messages that may register on the Input Range screen. The instrument is able to detect the input range for voltage and current channels A, B, C, and D.

Input Range	Description
OK	Within Range
OVER	Over Range
UNDER	Under Range
N/A	Channel Disabled
CLIP	Clipping

If input range is OVER, UNDER, or CLIP, then the rms readings will not be accurate. Using CTs below 10% of Full Scale may also cause inaccuracies in amplitude, phase and harmonic distortion readings.

Section B

Meter Mode

Overview

Introduction Meter mode allows you to view real-time meter data. The metered parameters available are logically separated into Standard and Distortion tabs. Meter screens are displayed in tabular form.

NOTE: Meter mode operation does not interfere with any of PowerVisa's other monitoring or recording functions. The individual voltage and current channel meter readings are not affected by the monitoring setup. Turning monitoring of individual channels off does not affect meter readings. Meter and Scope data is NOT available if you are viewing a stored file from the data card.

Metered parameters display

The PowerVisa is designed to provide setup as well as data display. Metered parameters are available for display regardless if they are being journalled under Setup New Circuit > Advanced Options > Journal Limit Setup. Users can trend journal entries by limits (Very High, High, Low, Very Low) or by time (users can set the time interval of how often rms and waveform snapshots will be recorded even when no disturbances occur). For the procedure on how to set entries under journal parameters, go to Chapter 6 Advanced Setup Options - Journal Limit on page 6-15.

In this section The following topics are covered in this section.

Topic	See Page
Standard Meter Tab	3-6
Distortion Meter Tab	3-8

Standard Meter Tab

Standard meter list Meter mode can be displayed by pressing the Meter icon on the Home screen. At start-up, meter mode defaults in the Standard tab featuring the basic power quality parameters available. The standard metering properties include Voltage, Computed Basic, Power, Demand, Energy, Harmonics and Flicker as shown below.

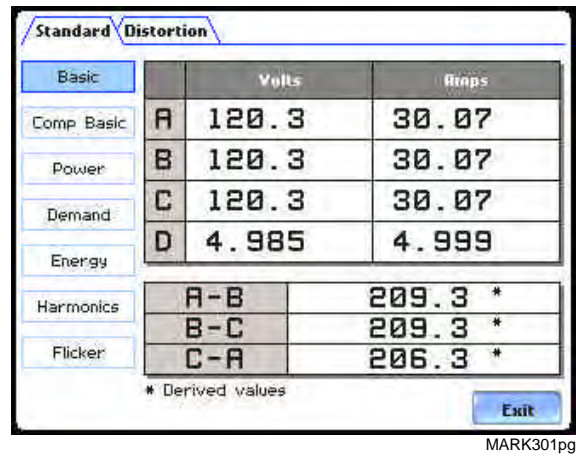

Standard Tab	Parameter Name	Label
Basic (for A, B, C, D)	Volts NOTE: Some voltage channel meter values are derived based on the circuit type selection. The values will change depending on the wiring configuration setup.	Volts
	Ampere	Amps
Computed Basic	Vector Displacement Power Factor	Vector Displacement PF
	Arithmetic Displacement Power Factor	Arithmetic Displacement PF
	Residual Current	Residual Current
	Net Current	Net Current
Power (for A, B, C, D, Total)	Watts	W
	Volts Ampere	VA
	Volts Ampere Reactive	VAR
	True Power Factor	TPF
	Displacement Power Factor	DPF

NOTE: See Appendix B Technical Specifications - Computed Parameters on page B-6 for definition of parameters.

Continued on next page

Standard meter list (continued)

Standard Tab	Parameter Name	Label
Demand	Active Power Demand	Active Power Demand
	Apparent Power Demand	Apparent Power Demand
	Reactive Power Demand	Reactive Power Demand
	RMS Current Demand Phase A	RMS Current Demand Ph A
	RMS Current Demand Phase B	RMS Current Demand Ph B
	RMS Current Demand Phase C	RMS Current Demand Ph C
	RMS Current Demand Average	RMS Current Demand Avg
Energy (for A, B, C, D, Total)	Watt Hours	Watt Hrs
	Volts Ampere Hours	VA Hrs
	Volts Ampere Reactive Hours	VAR Hrs
Harmonics (for A, B, C, D)	Voltage Total Harmonic Distortion	V THD
	Current Total Harmonic Distortion	I THD
	RMS Harmonic Current	RMS I Harm
	Harmonic Power Unsigned	Harm Pwr Unsigned
Flicker (for A, B, C)	Short Term Flicker	Pst
	Long Term Flicker (Sliding)	Plt (Slide)
	Long Term Flicker	Plt

Distortion Meter Tab

Distortion meter list The PowerVisa is able to meter distortions or uncharacteristic changes in the waveform of original signals. Distortion calculations measure the deviation of complex waveshapes from pure sine waves. Harmonics are measured in accordance with IEC 61000-4-7 Class I.

The screenshot shows a software interface with a 'Standard' dropdown menu set to 'Distortion'. On the left, there is a list of parameters: THD (selected), TID, TIF, Crest Factor, Power, and Transformer. The main area displays a table with the following data:

	VTHD fund	ITHD fund	VTHD RSS	ITHD RSS
A	0.098	1.000	0.201	0.213
B	0.016	0.998	0.016	0.212
C	0.098	1.000	0.201	0.213
D	0.104	0.841	<0.01	0.537

An 'Exit' button is located at the bottom right of the interface.

MARK311pg

Distortion Tab	Parameter Name	Label
THD (for A, B, C, D)	Voltage Total Harmonic Distortion Fundamental	V THD fund
	Current Total Harmonic Distortion Fundamental	I THD fund
	Voltage Total Harmonic Distortion Root Sum of Square	V THD RSS
	Current Total Harmonic Distortion Root Sum of Square	I THD RSS
TID (for A, B, C, D)	Voltage Total Interharmonic Distortion Fundamental	V TID fund
	Current Total Interharmonic Distortion Fundamental	I TID fund
	Voltage Total Interharmonic Distortion Root Sum of Square	V TID RSS
	Current Total Interharmonic Distortion Root Sum of Square	I TID RSS

Continued on next page

**Distortion meter
list (continued)**

Distortion Tab	Parameter Name	Label
TIF (for A, B, C, D)	Voltage Telephone Influence Factor Fundamental	V TIF fund
	Current Telephone Influence Factor Fundamental	I TIF fund
	Voltage Telephone Influence Factor RMS	V TIF RMS
	Current Telephone Influence Factor RMS	I TIF RMS
	Telephone Influence Factor Product	TIF Prod
Crest Factor (for A, B, C, D)	Voltage Crest Factor	Volts Crest Factor
	Current Crest Factor	Amps Crest Factor
Power (for A, B, C, D)	Signed Phase Harmonic Power	Signed
	Unsigned Phase Harmonic Power	Unsigned
Transformer (for A, B, C, D)	Transformer Derating Factor	Derating Factor
	K Factor	K Factor

Section C

Harmonics

Overview

Harmonics display

The PowerVisa allows users to view voltage and current harmonics/interharmonics in graphical or in list form. Harmonics are waveform distortion, a steady-state deviation from an ideal power frequency sinusoid and is characterized by the spectral content of the waveform. Interharmonics are frequency components between the harmonic frequencies. The IEC 61000-4-7 Standard dictates that harmonic analysis is done using a synchronous window of 10 cycles for 50 Hz, or 12 cycles for 60 Hz. This results in bins which are nominally 5 Hz wide. The actual width of the bins is equal to the actual frequency divided by 10 if the nominal frequency is 50 Hz, and 12 if 60 Hz. For example, if actually operating at 49.9 Hz, the bin is 4.99 Hz, but is labelled “5 Hz” as specified by the standard.

Use the respective touch screen buttons to display the next Channel (Channels A, B, C, D) and the next Parameter (V, I, W) of harmonic data. The number of harmonics/interharmonics displayed is up to the 60th. Summary values of odd, even and total distortion are displayed. A summary of harmonic distortion as well as interharmonic distortion values per phase/parameter are also available on display.

Users can determine the number or range of harmonic frequencies to trend and view in detail. There is also the option to select how to plot harmonic/interharmonic data and specify the units of measure by which harmonic data is calculated.

Harmonic Graph: Harmonics are measured in accordance with IEC 61000-4-7 Class 1. Users can choose the unit of measure by which harmonic data is calculated and graphed, based on a Percentage of the fundamental value or in Engineering units (volts and amps). Frequency components of harmonic graphs can be displayed either in Hertz or in Harmonic Number. The graphs can be zoomed and rescaled.

Harmonic List: The list gives a textual display of the following for each of the measured values: frequency and harmonic number; magnitude in Engineering units and percent of fundamental; phase in degrees (for harmonics only). This list is displayed in order of ascending frequency, and can also be sorted in order of descending magnitude.

In this section

The following topics are covered in this section.

Topic	See Page
Harmonic Graph	3-11
Harmonic Detail	3-12
Harmonic Options	3-13
Harmonic List	3-15

Harmonic Graph

Harmonic graph display The harmonic graph can be displayed by pressing Harmonics on the Home screen. The screen defaults to a graphical spectrum display, although users have the option to choose between the graph and list form. The screen will show a spectral graph featuring the amplitude of the harmonics relative to the fundamental frequency.

Use the properties under the Options button to select the vertical and horizontal measurement scale. The percent magnitude of the first 60 harmonics are graphed relative to the fundamental.

Total harmonic distortion (THD) on Odd contribution and Even contribution based on 127 harmonics*

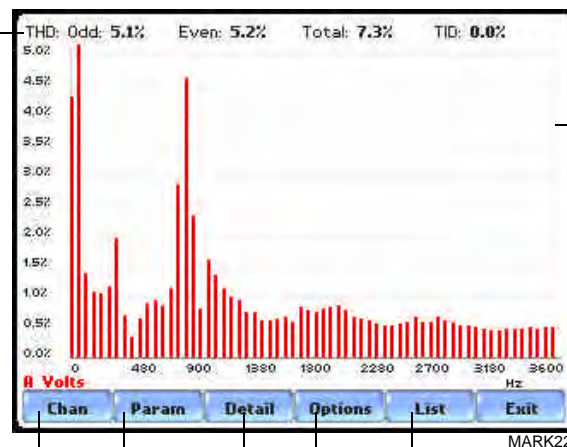

Display is updated approximately once per second

Switch channel display

Switch to V, I, or W

Magnify harmonic graph (p. 3-12)

Show harmonics text (p. 3-14)

Set harmonic options (p. 3-13)

*The odd contribution is the square root of the sum of the squares of the relative amplitudes of harmonics 3, 5, and 7 through $N-1$, where N is a function of sampling frequency. The even contribution is similar for harmonics 2, 4, and 6 through N . Total value is the square root of the sum of the squares of the odd and even distortions.

Harmonic Detail

The PowerVisa allows users to determine the numbers or the range of harmonic frequencies to trend. A blue box showing the default zoomed area appears once the Detail button is pressed. Touch any side of the zoom box to activate the drag function. Touch and drag the sides of the zoom box to expand or narrow in on a select number of harmonic/interharmonic graphs. The zoom box moves horizontally only. The vertical scale will autoscale when zoomed.

NOTE: To select whether the vertical is scaled to the fundamental or the greatest harmonic, use the Options key (see page 3-13).

Fundamental exceeds square so bar extends past top

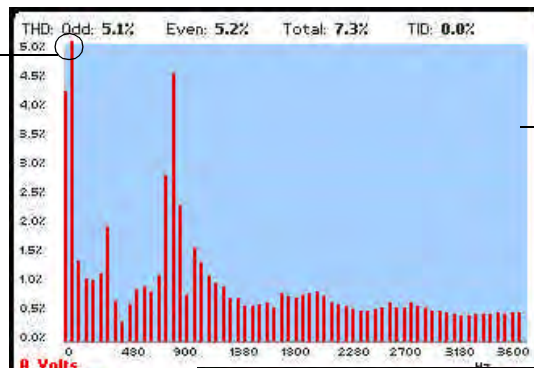

touch and drag zoom box to desired magnification scope

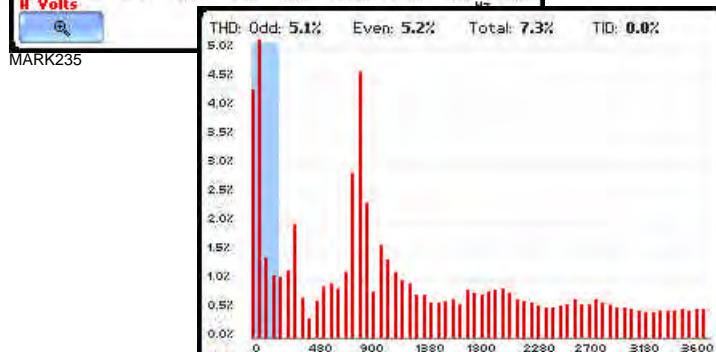

harmonic data plot (shown in channel color)

interharmonic data plot (shown in gray)

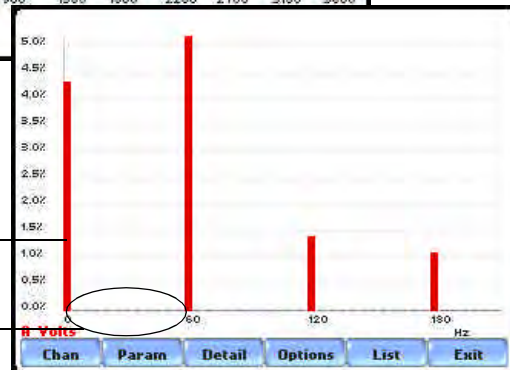

The magnify buttons serve as zoom function keys, each of which feature a plus sign or a minus sign within. Press **Zoom+** to display the zoomed area and view harmonic graphs in greater detail. Users may repeatedly zoom in on a plot for up to seven (7) levels. Press **Zoom-(n)** to unzoom graph display one increment at a time, where n is the counter of how many times the harmonic graphs have been magnified.

Harmonic Options

Harmonic/ Interharmonic data plots

The voltage and current harmonics and/or interharmonics for each phase channel can be trended using the Options button. The properties specified under Harmonic Options apply when harmonic/interharmonic data is viewed in either graph or list form.

Properties under **Show Harmonics...** pertain to both the graph and the list, and determine how the harmonics and interharmonics are used.

If **Show Harmonics... only** is enabled, then only the actual harmonics are shown.

If **Show Harmonics... and Interharmonics** is enabled, the spectrum will include all the (nominal) 5 Hz bins, which includes the actual interharmonics as well. On the graph, the harmonics are shown in the channel color, while interharmonics are shown in gray color. On the text, the harmonics are shown in boldface.

If **Show Harmonics... calculated including adjacent interharmonics** is enabled, the interharmonics are not explicitly shown but the harmonic values include the adjacent interharmonic values in their calculation, as specified by IEC 61000-4-7.

The IEC 61000-4-7 Standard specifies that the interharmonic bins adjacent to the harmonic be included in the computation of that harmonic. For example, if there was a 3rd harmonic (150 Hz) of 10%, and the value of the 145 Hz bin was 1%, and the value of the 155 Hz bin was 2%, then the value reported in the bin labelled “150 Hz” would also include contributions from the 145 Hz and 155 Hz bins. This would give

$$\sqrt{10^2 + 1^2 + 2^2} = 10.2\%, \text{ not } 10\%.$$

The following graphs illustrate harmonic computation as per IEC 61000-4-7 Standard.

Harmonic Computation for 50 Hz

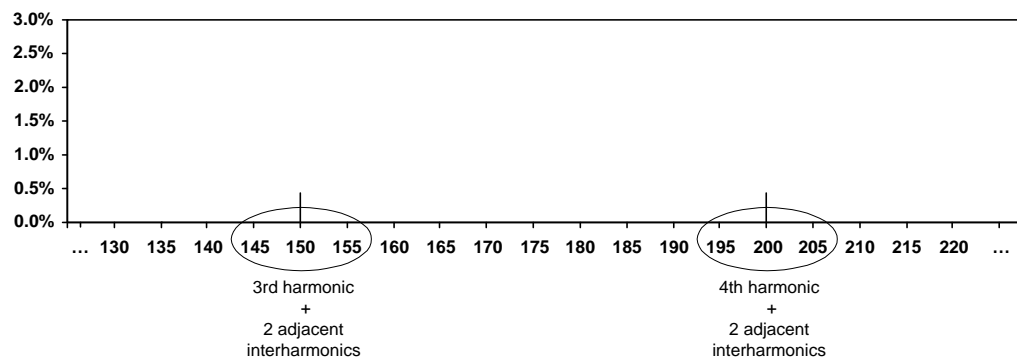

Continued on next page

**Harmonic/
Interharmonic
data plots
(continued)**

Harmonic Computation for 60 Hz

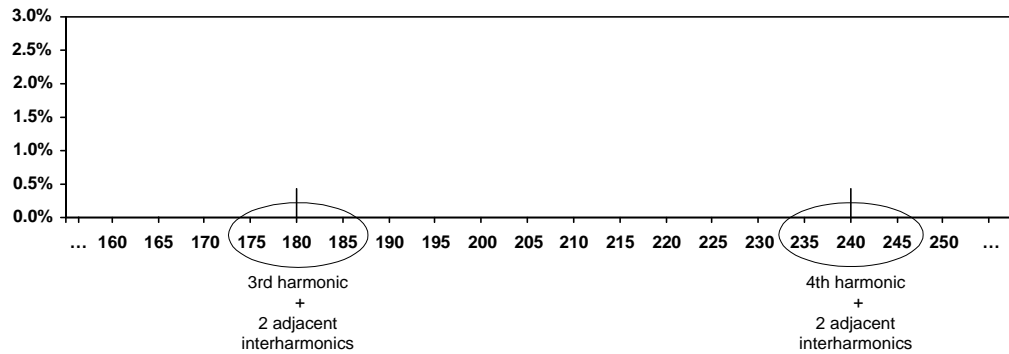

Properties under **Graph Units** pertain to the way the graph (not the list) is labelled. The vertical scale can be in **Percent** or **Engineering** units, and **Scale to Fund** (full scale) can be chosen to be the fundamental at 100% or the largest component. The engineering unit for voltage is volts and for current is amperes. The horizontal axis can be in **Hz** or **Harmonic Number**.

harmonic data display

measurement scale for frequency (x axis) and amplitude (y axis) of harmonics

full scale graph relative to fundamental frequency

THD: Odd 5.1% Even 5.2% Total 7.3% THD 0.0%

5.0%

4.5%

4.0%

3.5%

3.0%

2.5%

2.0%

1.5%

1.0%

0.5%

0.0%

Volts

3600

OK Cancel

Chan Param Detan Options List Exit

MARK236

Harmonic List

Harmonic text display

To view the harmonics magnitude text display, press List from the Harmonic graph screen on page 3-11. The harmonic parameters displayed on list include: (from leftmost column) the harmonic/interharmonic frequency in Hz, frequency in number, voltage rms or maximum load of current (depending on parameter selected), percent amplitude of harmonics, and harmonic phase angle value.

By default, harmonic and interharmonic frequency values are arranged per increment of 5Hz. Use the Sort button to organize harmonic text display according to percent magnitude of the first 60 harmonics relative to the fundamental, followed by the interharmonic values.

Harmonic phase degree values from 1 to 60 are displayed for voltage and current; while phase degree values from 1 to 50 are displayed for harmonic watts. Harmonic phase angle values can be normalized to the phase of the fundamental of the displayed channel. Use the Norm button to show the normalized phase angle values.

Hz	Volts	Harmonics Details	Phase Degrees
DC	5.059	4.2%	
5	0	0.0%	
10	0	0.0%	
15	0	0.0%	
20	0	0.0%	
25	0	0.0%	
30	0	0.0%	
35	0	0.0%	
40	0	0.0%	
45	0	0.0%	
50	0	0.0%	
55	0	0.0%	
60	1	119.8	100.0%
65	0	0.0%	0.9'
70	0	0.0%	
75	0	0.0%	
80	0	0.0%	

MARK237

Display is updated approximately once per second

Toggle between Normal and UnNormal phase values

Hz	Volts	Harmonics Details	Phase Degrees
60	119.8	100.0%	
900	15	5.418	4.5%
DC	0	5.059	4.2%
840	14	3.386	2.8%
960	16	2.750	2.3%
360	6	2.321	1.9%
1080	18	1.910	1.6%
120	2	1.647	1.4%
1140	19	1.621	1.4%
300	5	1.398	1.2%
1200	20	1.352	1.1%
780	13	1.350	1.1%
180	3	1.300	1.1%
240	4	1.243	1.0%
1260	21	1.204	1.0%
1320	22	1.126	0.9%
660	11	1.116	0.9%

MARK237b

Section D

Voltage and Current Phasor

Overview

Phasor display The phasor screen displays a graph that indicates the phase relations between the voltage and current based upon the angles of the fundamentals, as determined by Fourier analysis.

Phasor screen shows eight phasors autoscaled with zero degrees to the right (normally channel A voltage) for clockwise rotation and with synchronized channels. Users are allowed to display up to four channels at any one time for either volts or amps, or a single channel for both volts and amps, depending on the phases being monitored.

A touch screen Demo button presents an animated phasor demo rotation for resistive, capacitive and inductive loads.

In this section The following topics are covered in this section.

Topic	See Page
Phasor Screen	3-17
Phasor Rotation	3-18
Phasor Parameter/Channel Selection	3-20

Phasor Screen

Phasor screen display

The Phasor screen is displayed by pressing Phasor on the Home screen.

The Phasor screen shows eight phasors autoscaled with zero degree to the right for clockwise rotation and with synchronized channels. The left sidebar shows rms values for Volts/Amps for channels A, B, C and D; zero, positive and negative values for Volts/Amps; zero, positive and negative sequence component values for Volts/Amps.

Depending on the phases being monitored, up to four channels may be displayed at any one time for either Volts or Amps, or a single channel for both Volts and Amps. An arrow head and channel label are displayed on the vector.

Correct rotation is clockwise from 0°

If a channel is less than 20% of the maximum voltage (or current), the phasor is not displayed

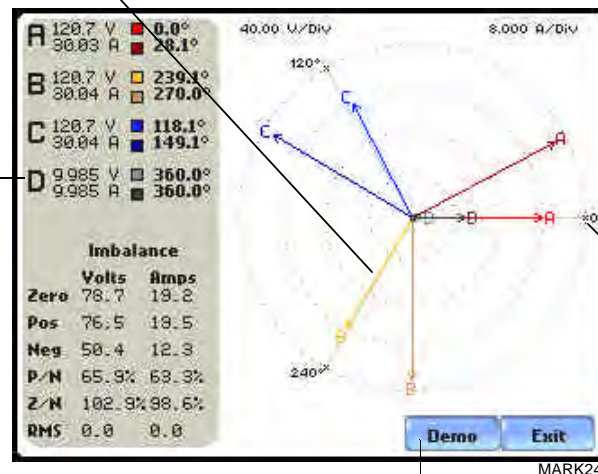

Sync channel is displayed at 0° - normally channel A voltage

Show animated phasor demo rotation for Resistive, Inductive and Capacitive loads (p. 3-18)

Phasor Rotation

Animated phasor rotation

Graphic illustration in the form of rotating phasors relative to the sine wave graph of a four wire wye circuit is available by pressing the Demo button on the Phasor screen (see page 3-17). The Demo button will be replaced by Start/Stop once phasor rotation has been viewed. Press Start to replay animated phasor rotation. Users can choose to Stop the phasor demo rotation at any time.

Phasor vectors are displayed using a clockwise rotation from the zero degrees reference. Animated phasor demo for Resistive, Inductive and Capacitive loads is available for viewing.

Sample 3-Phase, three wire delta rotation

The following diagrams describe the positive phase rotation of voltage and current phasors (for Resistive, Inductive and Capacitive loads) for a three phase, three wire delta connection. An arrow head on the line indicates direction pointing toward the load.

Three phase vectors are displayed as three lines, 120 degrees apart in a Resistive load

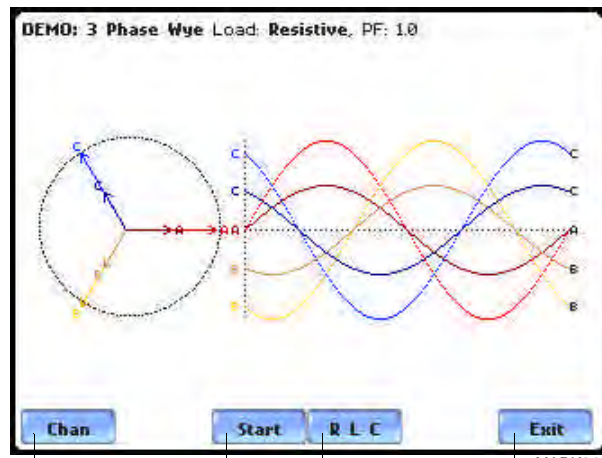

Display parameter/channel selection (p. 3-20)

Start/Stop demo plot waveforms as rotate phasors; press any time

Switch phasor demo rotation between Resistive, Inductive and Capacitive load effects; press any time (p. 3-19)

Return to Phasor screen

Continued on next page

**Sample 3-Phase,
three wire delta
rotation
(continued)**

The following diagrams describe the positive phase rotation of voltage and current phasors (for Resistive, Inductive and Capacitive loads) for a three phase, three wire delta connection. An arrow head on the line indicates direction pointing toward the load.

Three phase vectors are
displayed as three lines, 120
degrees apart in an Inductive
load

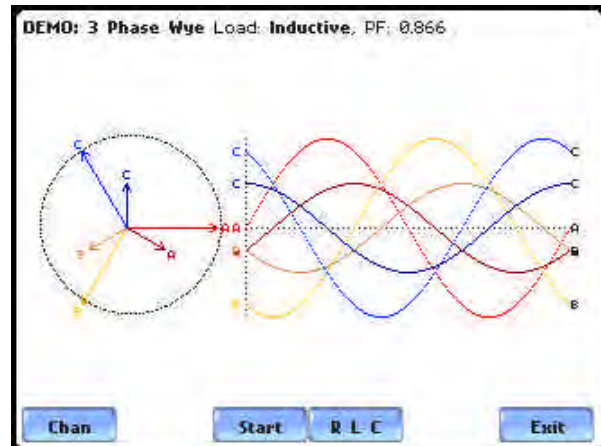

MARK243

Three phase vectors are
displayed as three lines, 120
degrees apart in a Capacitive
load

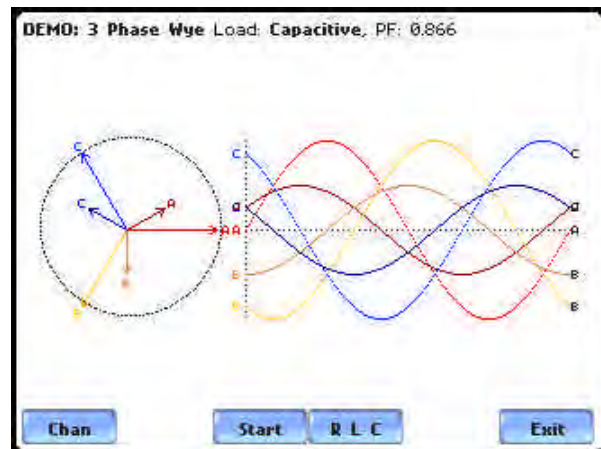

MARK244

**Phasor
diagrams**

Refer to Appendix E for the diagrams that describe the voltage and current phasors for the standard type of power connections.

Phasor Parameter/Channel Selection

Parameter/Channel display The Parameter/Channel selection screen is displayed by pressing Chan on the phasor Demo screen. Depending on the phases being monitored, up to four channels may be displayed at any one time for either Volts or Amps, or a single channel for both Volts and Amps.



MARK245

Press to enable/disable the parameter/channel for display in the animated phasor rotation. Any of the following will turn channels on/off:

- Press the desired Volts/Amps channel to turn it on/off.
- Press Volts or Amps button to turn on/off all channels of that parameter.
- Press A, B, C, D to turn on/off both the Volts and Amps for that channel.

Press OK to accept channel selection. The phasor Demo rotations will display the parameters/channels enabled.

CHAPTER 4



Instrument Settings

Overview

Introduction This chapter describes the miscellaneous tasks that users can perform to keep the PowerVisa running efficiently. These are tasks that users might perform only occasionally.



In this chapter The following topics are covered in this chapter.

Topic	See Page
Access Instrument Settings Menu	4-2
Time and Date Settings	4-3
Select Language	4-5
Set Display Preferences	4-6
Touch Screen Calibration	4-7
Turn Threshold Beeper On/Off	4-9
Communications	4-10
Data Card	4-12
Reset to Factory Configuration	4-14

Access Instrument Settings Menu

Preferences menu screen

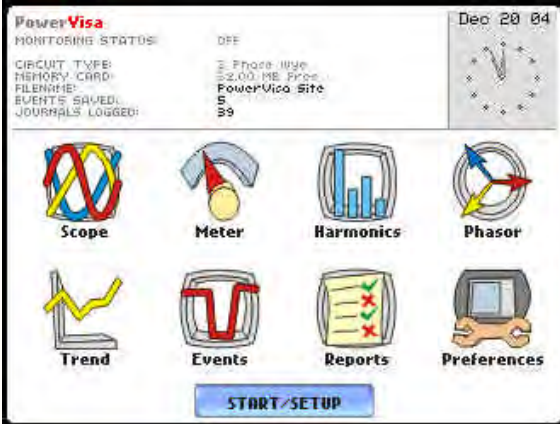
All functions in this chapter are found under the Instrument Settings menu. Follow these steps to display the Instrument Settings menu screen.

Action...	Result...
<p>STEP 1: Press the PowerVisa On/Off power button to turn the unit on. The Home screen will be displayed.</p>	
<p>STEP 2: Press Preferences. The Instrument Settings Setup Menu will be displayed.</p>	

Time and Date Settings

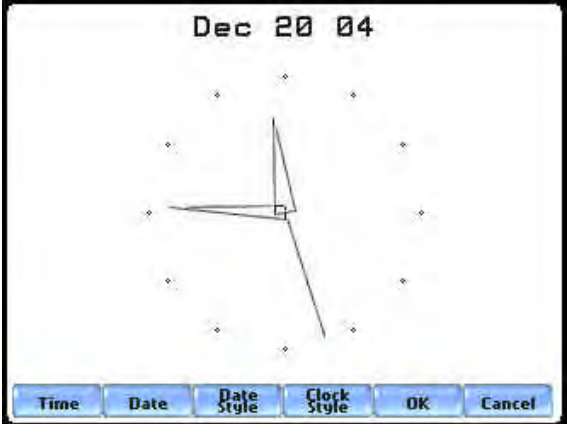

Time and Date display

Users have the option not only to set the exact time and date, but also to select the format of how time and date will appear on screen.

Action...	Result...
<p>STEP 1: From the Instrument Settings Setup Menu screen, press Time and Date.</p> <ul style="list-style-type: none"> • Press Time if you want to change the time settings. Proceed to Step 2 on page 4-4. • Press Date if you want to change the date settings. Proceed to Step 3 on page 4-4. • Press Date Style to select the format in which you want date displayed on screen. View the three different date format selections each time you press Date Style. <ul style="list-style-type: none"> • mm/dd/yy format • dd/mm/yy format • yy/mm/dd format • Press Clock Style to select the format in which you want time displayed on screen. View the three different time format selections each time you press Clock Style. <ul style="list-style-type: none"> • analog • digital using 1 to 12 hr format (AM/PM) • digital using 1 to 24 hr format • Press OK to accept new time/date settings and return to Instrument Settings menu. • Press Cancel to discard changes in time/date settings and return to Instrument Settings menu. 	 <p style="text-align: right; font-size: small;">VISA152</p>

Continued on next page

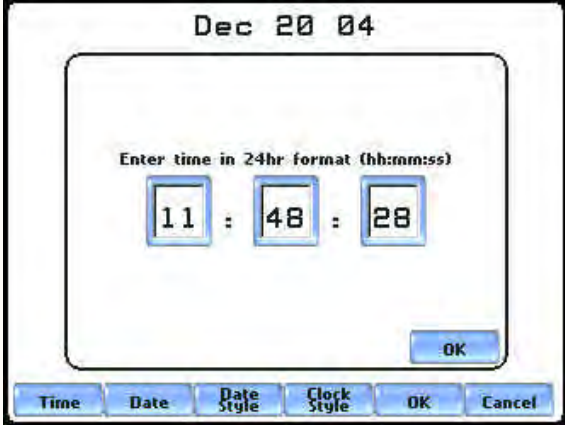
Time and Date Display (continued)

Action...	Result...
<p>STEP 2: Press the field representing hours, minutes, and seconds to change time settings. Use the numeric keypad to enter new time settings. Time should be entered in a 24-hour format (example: 16:00:00 for 4:00 PM).</p> <ul style="list-style-type: none"> • Press OK to accept changes in time settings. • Press Cancel to discard changes in time settings. <p>NOTE: Clock time and format can be changed anytime following this same procedure.</p>	 <p style="text-align: right; font-size: small;">VISA153</p>
<p>STEP 3: Press to select the month, day, and year. Enter the year using numbers from the keypad.</p> <ul style="list-style-type: none"> • Press OK to accept changes in date settings. • Press Cancel to discard changes in date settings. <p>NOTE: Date settings and format can be changed anytime following this same procedure.</p>	 <p style="text-align: right; font-size: small;">VISA154</p>

Select Language

Select Language The PowerVisa menu screens appear in the English language by default.

Action...	Result...
<p>STEP 1: From the Instrument Settings Setup Menu screen, press Language.</p> <ul style="list-style-type: none">• Check to select the desired language in which you want display screens to appear.• Press OK to accept language selection. The screen will return to Instrument Settings menu.• Press Cancel to retain present language.	 <p>PVISA155</p>

Set Display Preferences

LCD settings

User programmable settings for the LCD screen include the backlight timer, contrast, password protect, parameter/channel colors, and touch screen calibration.

Action...	Result...
<p>STEP 1: From the Instrument Settings Setup Menu screen, press Display Preferences.</p> <ul style="list-style-type: none"> Automatic backlight shutoff timer is provided for the LCD display. Press Backlight Timer to automatically turn off backlight after 1, 2, 5, 10 or 15 minutes of no user activity. Set the Backlight Timer to Always On if you do not want the backlight to shut off. <p>NOTE: The auto-shutoff feature extends the life of the battery and should be duly considered.</p> <ul style="list-style-type: none"> Press Contrast to brighten/dim screen display to preferred percentage. Press Password Protect to enable/disable password log in code to the PowerVisa. When password protect is enabled and the user reactivates the unit from auto-shutoff (see Backlight Timer setting), the keypad screen used to enter the password will appear. The user will have to enter the correct password to continue using the PowerVisa. The message Invalid Password! will appear when an incorrect password is entered. Press Channel Colors to change the color of the parameter/channel display. Select desired color from a 28 color selection grid. Press Calibrate Touch Screen to calibrate the unit's touch screen functionalities. Proceed to page 4-7. Press Exit to return to Instrument Settings menu. 	 <p>MARK156</p>



Touch Screen Calibration

Calibration procedure

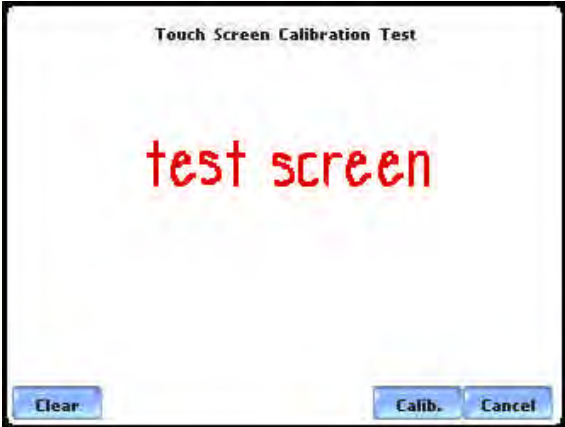
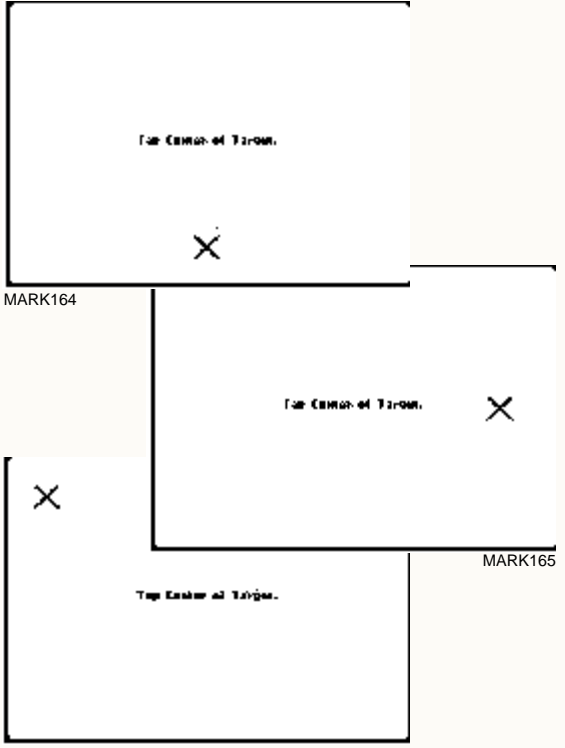
The PowerVisa is able to perform calibration to ensure the proper operation of the unit's touch screen functionalities. The calibration procedure will correct the problem of out of tolerance touch screen malfunction. Note that errors corrected by this calibration procedure are specific only to touch screen operation.

Action...	Result...
<p>STEP 1: From the Display Setup Menu (see page 4-6) screen, press Calibrate Touch Screen. Test if touch screen recognition operates properly by applying pressure on the LCD screen.</p> <ul style="list-style-type: none"> • Press Clear to reset LCD screen and delete display markings. • Press Calib to begin touch screen calibration procedure. Proceed to Step 2. • Press Cancel to end calibration test and return to Display Setup. 	 <p>MARK164b</p>
<p>STEP 2: Follow the instruction Tap Center of Target to begin calibration. Target object X is initially located in the lower middle section of the screen.</p> <ul style="list-style-type: none"> • A series of screens will flash showing movement of the target object: from the lower middle section to mid-right and finally to upper left section of the screen. • To end touch screen calibration, tap the center of the target object X now located in the upper left section of the screen. Proceed to Step 3 on page 4-8. 	 <p>MARK164</p> <p>MARK165</p> <p>MARK166</p>

Calibration procedure (continued)

Action...	Result...
<p>STEP 2: Once touch screen calibration is done, a message will appear to indicate Touch screen was successfully calibrated.</p> <ul style="list-style-type: none"> • Press OK to continue on with calibration test verification. Proceed to Step 3. 	 <p>MARK167</p>
<p>STEP 3: Test if touch screen recognition operates properly by applying pressure on the LCD screen.</p> <ul style="list-style-type: none"> • Press Clear to reset LCD screen and delete display markings. • Press Accept to complete the touch screen calibration procedure. Accepting will save and store new touch screen calibration data in memory. Once the new data is stored, the old touch screen calibration data is lost. The screen will return to the Display Setup Menu. • Press Cancel to discontinue the touch screen calibration procedure. Pressing Cancel will retain the previous touch screen calibration constants, no new calibration data will be stored in memory. The screen will return to the Display Setup menu. 	 <p>MARK168</p>

Turn Threshold Beeper On/Off

Audible alarm When set to ON, the unit will beep when threshold limits are crossed and other event triggers occur. The beep that provides audible feedback to pressing touch screen key is not affected by this setting.

Action...	Result...
<p>STEP 1: From the Instrument Settings Setup Menu screen, press Turn Beeper On/Off.</p> <ul style="list-style-type: none">• The unit can provide audible alarm signals when triggered. Press Threshold Beeper to turn the alarm On or Off.• Press Exit to return to Instrument Settings menu.	 <p>The screenshot shows a screen titled "Set: Threshold Beeper". It features a blue square icon on the left and the text "Threshold Beeper: ON" in the center. At the bottom right, there is a blue button labeled "Exit".</p> <p>MARK157</p>

Communications

Communication interface setup

Communications Settings is where instrument-specific information is entered to allow the PowerVisa to communicate to external devices using the optional Isolated Communications Module assemblies or modem (see related information on Chapter 9 Downloading Events).

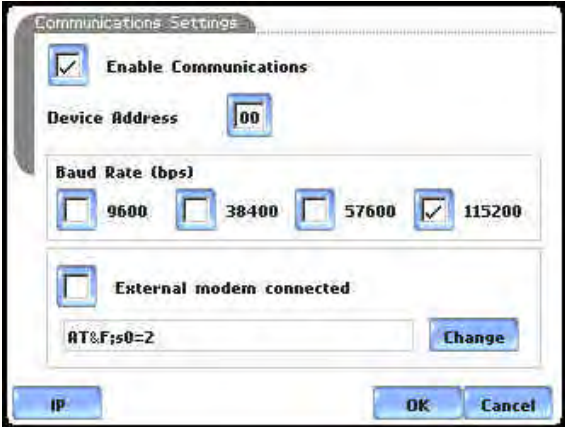
Action...	Result...
<p>STEP 1: From the Instrument Settings Setup Menu screen, press Communications.</p> <ul style="list-style-type: none"> • Press Enable Communications to activate/deactivate the communications port. External communication devices connect to the PowerVisa mainframe via the optical serial data port. The optical serial data port connector is located on the left side of the instrument. • Press to enter the communications Device Address from 01 to 32 for use with the optional Fiber Optic to Ethernet adapter. • Select the corresponding Baud Rate to set connection speed. Default baud rate is 11520. • Press External Modem Connected if you want to activate communications via an external modem. Press Change to modify the modem initialization string. The string must begin with “AT”. Dranetz-BMI recommends using the same brand and model of modem at both ends of the communications link. See Chapter 9 Downloading Events for instructions on modem connections. • Press IP to configure your Ethernet settings and allow the PowerVisa to operate on the network. Proceed to Step 2 on page 4-11. • Press OK to accept changes in communications settings. • Press Cancel to discard changes in communications settings and return to Instrument Settings menu. 	 <p style="text-align: right; font-size: small;">MARK159</p> <p>NOTE: For instructions on how to physically connect to NodeLink using the external communications devices, see Chapter 9 Downloading Events.</p>

Communication interface setup (continued)

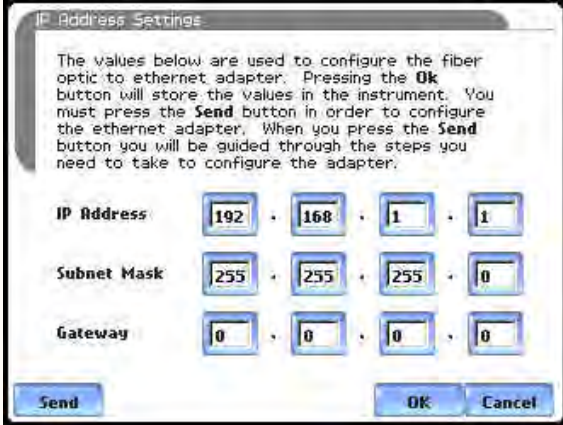
Action...	Result...
<p>STEP 2: Entering the correct IP address settings will enable the PowerVisa to communicate with the network.</p> <p>Prior to entering the IP settings, make sure that the PowerVisa is connected to the computer network via the Fiber optic to Ethernet Adapter (P/N COMM-OEA).</p> <p>After you have determined the proper IP address and settings, proceed as follows:</p> <ul style="list-style-type: none"> • Type in your Ethernet IP Address in the appropriate fields. Use the numeric keypad to enter the IP setting. • Type in your Ethernet Subnet Mask in the appropriate fields. Use the numeric keypad to enter the Subnet Mask setting. • Type in your Gateway in the appropriate fields. Use the numeric keypad to enter the Gateway setting. <p>When done entering IP settings, press OK. Pressing OK will store the values in the instrument.</p> <p>Press Send to configure the Ethernet adapter using the new IP address settings. Follow the instructions that appear on screen to complete the IP setting configuration procedure.</p> <p>Press Cancel to ignore changes and retain the previous IP settings, no new values will be stored in the instrument.</p>	 <p style="text-align: right; font-size: small;">MARK159b</p>

Data Card

Format/View data card

The Memory Card screen displays information on the card inserted in the data card slot, including the amount of total space, available space, and used space in card. The Memory Card screen also prompts users to set filename and format card in preparation for monitoring and writing of data.

Action...	Result...
<p>STEP 1: From the Instrument Settings Setup Menu screen, press Memory Card.</p> <ul style="list-style-type: none"> • Card Status indicates status condition of the card inserted in the data card slot. The following messages may appear under Card Status (refer to pages 5-20 to 5-21 for a detailed description of each card status message): <ul style="list-style-type: none"> • Not Inserted • Contains File • Empty • Fragmented • Unformatted • Invalid Card • Card size indicates the full storage capacity of the data card. The amount of remaining space and used space in data card are also displayed on screen. • Press Format to format the data card. Proceed to Step 2 on page 4-13. • Press View to display files stored in data card. Proceed to Step 3 on page 4-13. • Press Exit to discard changes and return to Instrument Settings menu. 	<div data-bbox="857 596 1421 1024" style="border: 1px solid black; padding: 5px;"> <p style="text-align: right; font-size: small;">MARK160</p> </div> <p>NOTE 1: The PowerVisa does not support file fragmentation. When creating a file, it will take the largest continuous block and use that size block for data storage. Deleting files from data card is not recommended. Whenever possible, transfer the files to a computer and then reformat the card using the PowerVisa when there is no more space available to begin new data storage.</p> <p>NOTE 2: Refer to Chapter 5 Start Menu - Site Name/Memory Card on pages 5-20 to 5-23 for more information on data card operation.</p>

Continued on next page

Format/View data card (continued)

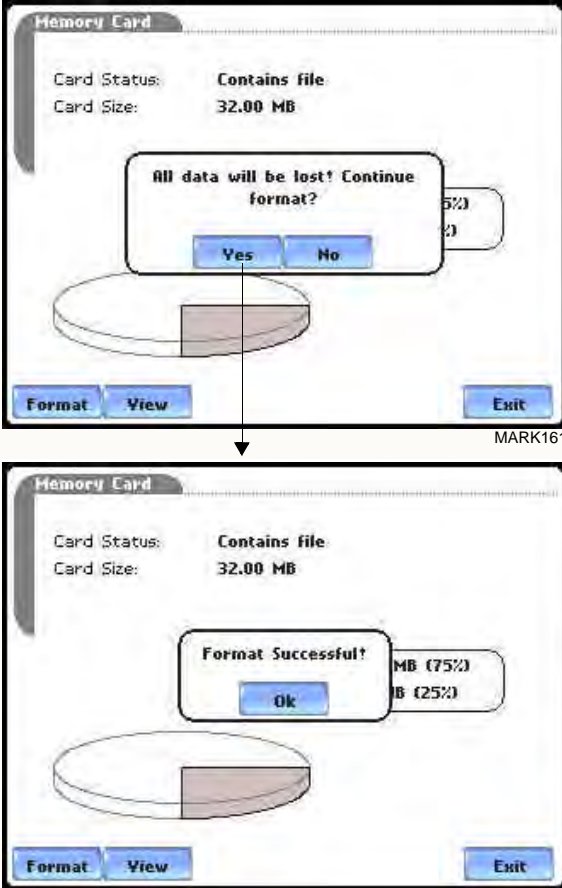
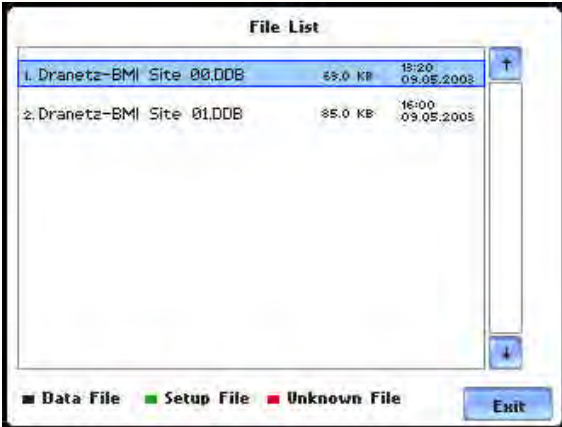
Action...	Result...
<p>STEP 2: All data and setups stored in data card will be lost when you format the card.</p> <ul style="list-style-type: none"> A confirmation message verifies whether you want to continue with data card format or not. <p>Press Yes to continue data card format. Press No to cancel data card format.</p> <ul style="list-style-type: none"> The message Format Successful! indicates that data card format has been completed. Press OK to exit card format procedure and return to the Memory Card screen. 	 <p>MARK161</p> <p>MARK162</p>
<p>STEP 3: The PowerVisa lists data file names stored in card, along with file size, time and date when data was recorded. The text color indicates the type of file: black is for data file (.ddb), green is for setup file (.set), and red is for an unknown file.</p> <ul style="list-style-type: none"> Press Up/Down arrow keys to scroll the page up or down by one line. Press and drag the scroll bar to move the page up or down. Press Exit to quit and return to Memory Card screen. 	 <p>MARK163pg</p>

Reset to Factory Configuration

Definition Factory configurations are the default settings of all programmable features of the PowerVisa as it left the factory.

Procedure Follow these steps to reset the PowerVisa to its factory configuration.

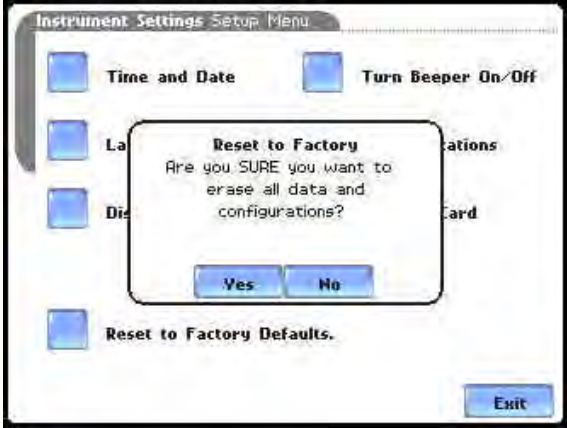
Action...	Result...
<p>STEP 1: From the Instrument Settings Setup Menu screen, press Reset to Factory Defaults.</p> <p>A confirmation message verifies if you want to reset the instrument to factory configuration and lose all new data and settings.</p> <ul style="list-style-type: none">• Press Yes to erase existing settings and reset the instrument to factory-configured setups. The screen will return to the Instrument Settings menu.• Press No to cancel.	 <p>The screenshot shows the 'Instrument Settings Setup Menu' with a central dialog box titled 'Reset to Factory'. The dialog box asks, 'Are you SURE you want to erase all data and configurations?' and has 'Yes' and 'No' buttons. The background menu includes options like 'Time and Date', 'Turn Beeper On/Off', 'La...', 'Di...', and 'Reset to Factory Defaults.' with an 'Exit' button at the bottom right. The text 'MARK158' is visible in the bottom right corner of the screenshot area.</p>

Factory default settings

Dranetz-BMI has set the default values for the various parameters of the PowerVisa.

Current Probes: *TR2500/TR2500A for A, B, C; TR2510/TR2510A for D*

Scale Factors: *1:1 for V and I, channels A, B, C, D*

Circuit Type: *three phase wye*

Mode of Operation: *monitor*

Nominal Value: *measured V, I, frequency*

Monitoring Mode: *Standard Power Quality*

Advanced Operations: *individual limit setups*

Transient Limits: *instantaneous peak = 3X nominal V, waveshape = 10% ,
rms dev = 10%*

RMS Variation Limits: *10% Very Low, 90% Low, 110% High for voltage; none for current*

Journal Limit: *journalling By Time for the various parameters*

Triggers: *all V trigger; all V and I channels*

Journal Interval

Power Values:

Power Values Interval: *15 minutes*

Waveform Snapshot: *On*

Demand and Energy:

Demand Sub-Interval: *5 minutes*

Sub-Intervals per Interval: *3*

Harmonics Journal Interval: *15 minutes*

Flicker:

Pst (Short Term) Interval: *10 minutes*

Plt (Long Term) Interval: *2 hours*

Site Name: *PowerVisa Site*

Clock Type: *Analog*

Date: *mm/dd/yy*

Language: *English*

Display

Backlight Timer: *1 minute*

Contrast: *70%*

Password Protect: *OFF*



CHAPTER 5



Start Menu

Overview

Start menu options

The Start Menu allows users to perform the following: set up the PowerVisa for monitoring of an electrical system, load previously saved setups from card, and load data from card.

There are three ways to set up the instrument for monitoring. The length of time to monitor a circuit can vary from a few hours to a few weeks depending on the user application.

- Automatic Setup automatically configures the instrument's circuit type, voltage and current channels, and parameter thresholds. The auto-configured setup enables users to proceed directly with data monitoring.
- Wizard Setup takes the user through a series of screens prompting for information about the circuit to be monitored. The unit automatically turns on the correct voltage and current channels when user selects a circuit type. Parameter thresholds are automatically set based on the line voltage and current values that the user enters. Threshold limits for capturing events are also set according to the monitoring mode selected.
- Advanced setup options (see Chapter 6) allow the user to modify trigger parameters and intervals that were previously set up through Automatic or Wizard setups. Under advanced setup, each channel must be turned on individually, but any combination can be used. Threshold limits can be set to any value within the acceptable range. The user can turn on any available parameter. Users have wider control over all setup functions when using advanced setup options.



Selection of setup method typically depend on user application and extent of familiarity with the operation of the instrument.

Monitor same circuit makes use of the existing setup for monitoring. If a template of setups has been previously saved to the card, you may load it using the menu below.

Load setup template from card enables you to use previously saved setups. If you wish to load a previously saved data file from the card, use the menu below.

Load data from card allows you to transfer saved events from data card to the PowerVisa.

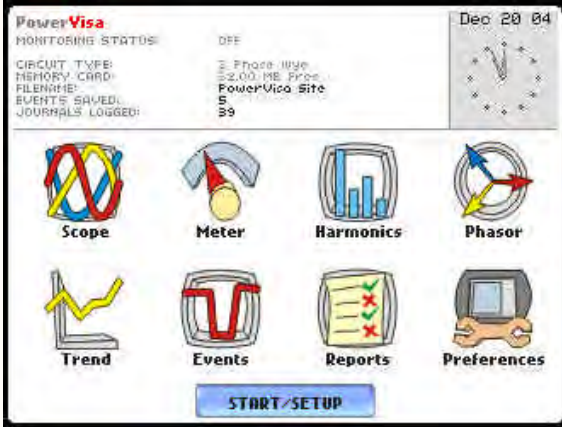
Displaying Start Menu Follow these steps to display the Start Menu.

Action...	Result...
<p>STEP 1: Press the PowerVisa On/Off power button to turn the unit on. The Home screen will be displayed.</p>	 <p style="text-align: right;">PVISA001</p>
<p>STEP 2: Press Start/Setup. The Start Menu will be displayed.</p>	 <p style="text-align: right;">MARK100</p>

In this chapter This chapter is divided into five sections:

Section	Title	See Page
A	Automatic Setup	5-3
B	Wizard Setup	5-5
C	Monitor Same Circuit	5-24
D	Load Setup Template from Card	5-34
E	Load Data from Card	5-35

Section A

Automatic Setup

Overview

Automatic Setup procedure Automatic Setup is a one-stop process using pre-defined settings to set the unit automatically. Users have the option to view the list of parameter settings, change probe types if current will be monitored, and/or proceed directly with data monitoring. Follow these steps to perform Automatic Setup.

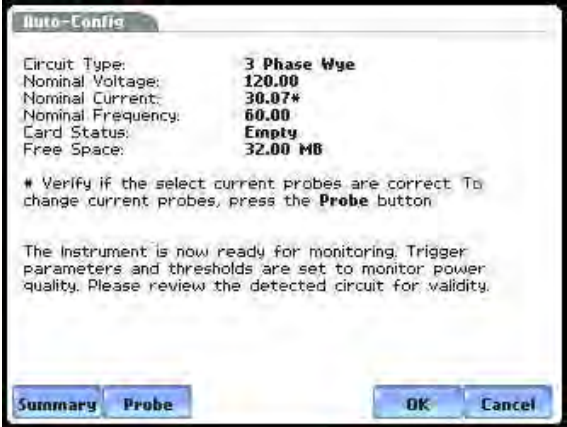
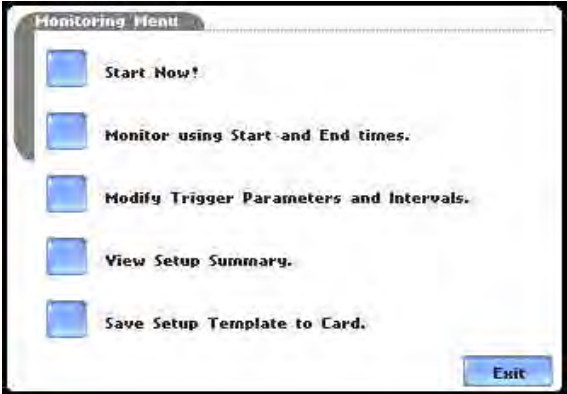
Action...	Result...
<p>STEP 1: From the Start Menu, press Automatic Setup. The auto-configured circuit type, nominal voltage, current and frequency values appear on screen. Data card status and available space in card are also displayed.</p> <ul style="list-style-type: none"> • To continue Automatic Setup and begin data monitoring, press OK. Proceed to Step 2. • To view the list of parameter settings for Automatic Setup, press Summary. Proceed to Step 3 on page 5-4. • To display/change probe types for current monitoring, press Probe. Proceed to Step 4 on page 5-4. • Press Cancel to quit and return to Start Menu. 	 <p style="text-align: right; font-size: small;">MARK101a</p>
<p>STEP 2: The Monitoring Menu screen allows users to begin monitoring immediately or at a specified time and date.</p> <ul style="list-style-type: none"> • To start monitoring, press Start Now! <p>Proceed to Section C Monitor Same Circuit - Turning Monitoring On/Off on page 5-24.</p>	 <p style="text-align: right; font-size: small;">MARK123b</p>

Continued on next page

Automatic Setup procedure (continued)

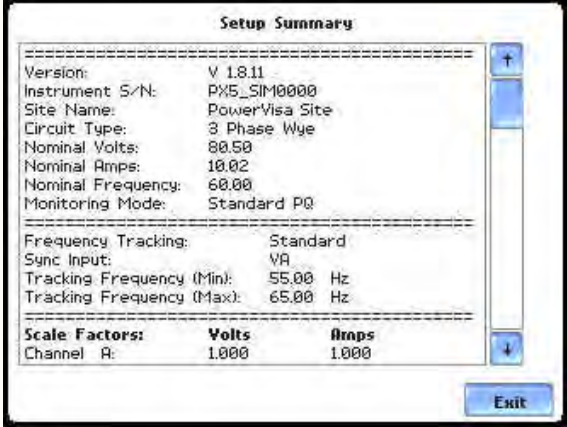
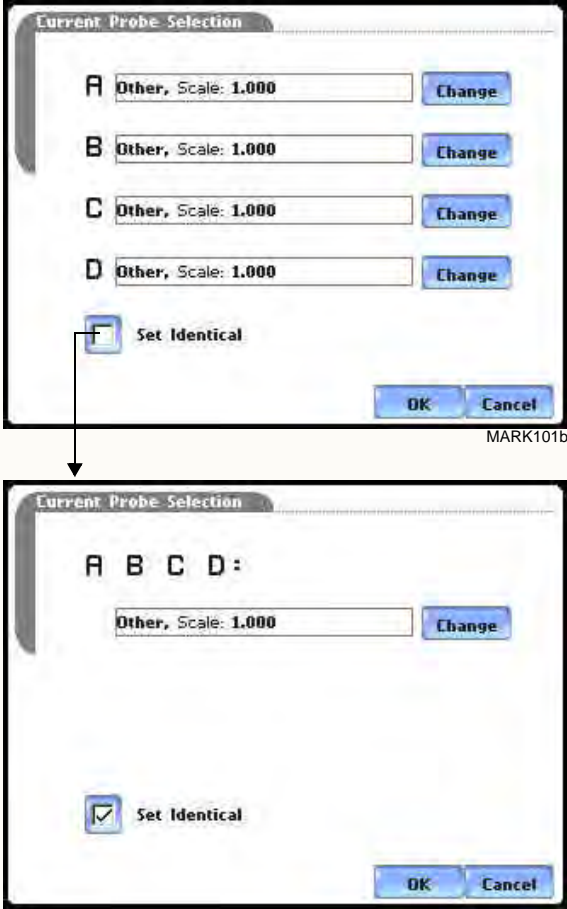
Action...	Result...
<p>STEP 3: Summary displays the list of auto-configured parameter settings for auto setup. The setup summary is available for review before, during and after monitoring.</p> <ul style="list-style-type: none"> • Press Up/Down arrow keys to scroll the page up or down by one line. • Press and drag the scroll bar to move the page up or down. • When done reviewing the Setup Summary, press Exit. The screen will return to Auto-Config. 	 <p>VISA123</p>
<p>STEP 4: Various probe types are available for each channel for current monitoring.</p> <ul style="list-style-type: none"> • Press Change to display the probe types available for each channel. Proceed to Step 5 on page 5-5. • If using identical probe type for all Channels, press to enable Set Identical. The display will change to show only one probe selection for all channels. Press Change to display the probe types available. Proceed to Step 5 on page 5-5. • Press OK to accept probe selection and return to Auto-config screen. • Press Cancel to disregard probe selection and return to Auto-config screen. 	 <p>MARK101B</p> <p>MARK103B</p>

Continued on next page

Automatic Setup procedure (continued)

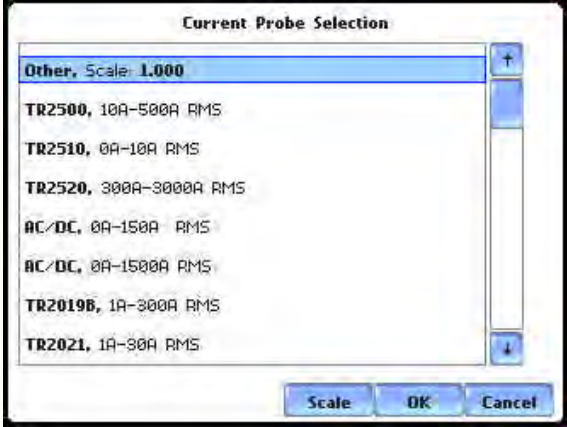
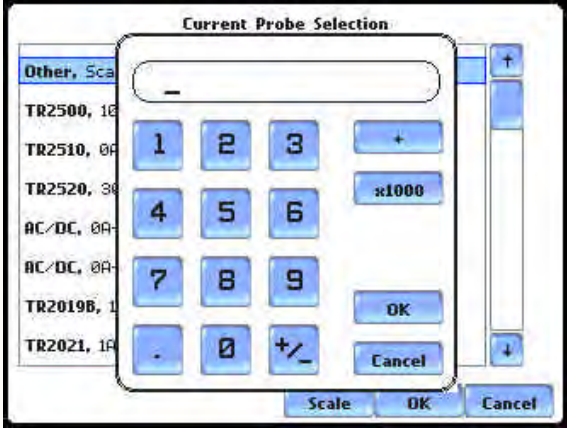
Action...	Result...
<p>STEP 5: Select your desired probe type.</p> <p>NOTE: Use the same probes for the following: TR2500 for TR2500A, TR2510 for TR2510A, TR2520 for TR2520A.</p> <ul style="list-style-type: none"> • If the current probe that you are using is not on the list, select Other. Then press Scale to define the CT scale factor on the current probe. Proceed to Step 6. • Press OK to accept probe selection and monitor current. • Press Cancel to retain previous probe settings and return to previous screen. 	 <p>MARK123bpg</p>
<p>STEP 6: You need to set the CT scale factor when using a current probe that is not on the list. Pressing Scale will show the numeric window to enter the CT scale factor on the current probe. Use the keypad to set the CT scale factor. See sample scale factor calculation on page 5-10.</p> <ul style="list-style-type: none"> • Press OK to accept the CT scale factor value. The Current Probe Selection screen will be displayed. • Press ← if you want to clear and retype numeric values. • Press x1000 to multiply the value by 1000. • Press Cancel to discard changes and return to the previous screen (screen shown on Step 5). 	 <p>MARK101b</p>

Section B

Wizard Setup

Overview

Introduction

Wizard Setup guides the user through the circuit setup step-by-step, via a series of screens prompting for information about the circuit to be monitored. The unit automatically turns on the correct channels, sets the parameter thresholds and waveform capture settings depending on the detected circuit type, nominal voltage and current values, and monitoring mode specified by the user.

Monitoring modes

The PowerVisa allows users to monitor events in the following setup categories: Standard Power Quality, Long-term Timed Recording, Continuous Data Logging, and EN50160 Power Quality mode. Selecting any setup category automatically sets trigger and capture conditions. Advanced users are free to mix and match settings (see Chapter 6 Advanced Setup Options).

Standard Power Quality, Demand, Energy: The PowerVisa algorithms automatically evaluate existing rms and waveform conditions to optimize setups to reliably capture data. This feature ensures that the first-time user gets the expected results, while providing the experienced user with the ability to tweak settings for specific applications. Either way, the necessary data used to identify critical events and optimize mitigation solutions is recorded into the data card as it occurs.

Long-term Timed Recording, Demand, Energy: Performing a statistically valid power quality energy survey requires the capture of a set of basic data over an extended period of time. The PowerVisa is designed to facilitate long-term monitoring by collecting min/max/avg data at each pre-determined interval in order to perform post-process harmonic and other events analysis. It is also designed to be left unattended in the field, recording statistically representative data for long-term analysis. Using the Dranetz-BMI lockable portable case option or other available enclosures, power quality studies can be carried out in harsh weather environments.

Continuous Data Logging, Demand, Energy: This logs the rms and power values once per second for totally gapless logging. Cyclic triggers are disabled. No waveforms are recorded in this monitoring mode.

Continued on next page

Monitoring modes (continued)

EN50160 Power Quality: EN50160 monitors and reports Quality of Supply (QOS) compliance as specified by the EN standard. The seven parameters required by EN50160 to determine QOS compliance are: Power Frequency, Supply Voltage Variations, Flicker, Supply Voltage Unbalance, Harmonic Voltage, Interharmonic Voltage, and Mains Signalling. A full discussion on EN50160 is found on Chapter 8 Reports.

In this section

The following topics are covered in this section.

Topic	See Page
Current Probe Selection	5-8
Scale Factor Setup	5-10
Circuit Type Selection	5-12
Nominal Values	5-14
Mode of Operation	5-17
Monitoring Mode	5-18
Advanced Options	5-19
Site Name/Memory Card	5-20

Current Probe Selection

Selecting current probe

Follow these steps to monitor current and select probe type.

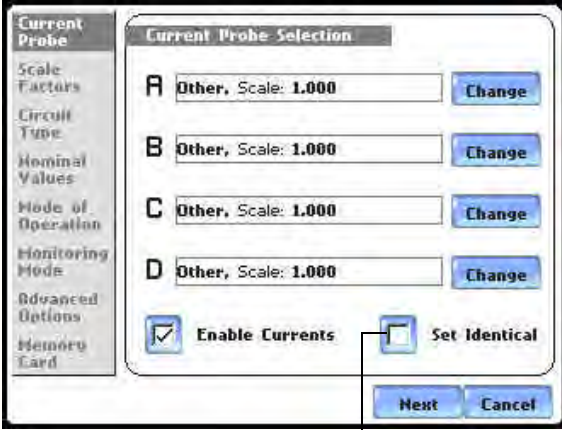
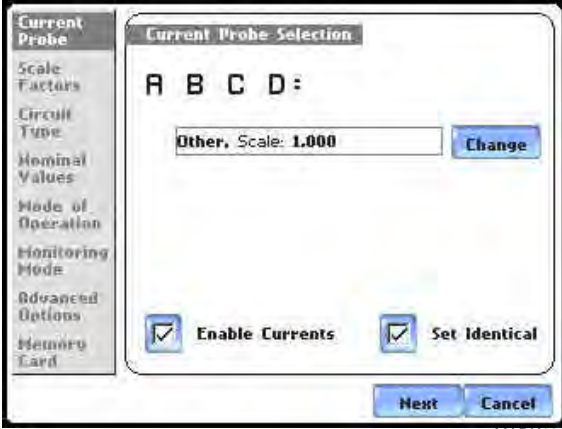
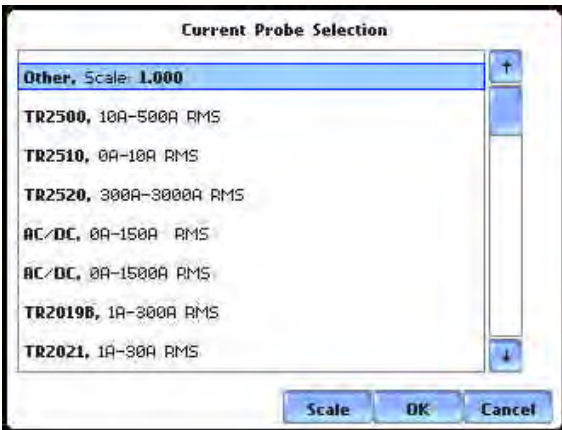
Action...	Result...
<p>STEP 1: From the Start Menu, press Setup new circuit.</p> <ul style="list-style-type: none"> • If current will not be monitored, press Next. Go to page 5-10. • If current will be monitored, press Change to display the probe types available for each channel. Proceed to Step 2. • If using identical probe type for all channels, press to enable Set Identical. The display will change to show only one probe selection. Press Change to display the probe types available. Proceed to Step 2. • If you want to enable/disable current channels, press to select/deselect Enable Currents. • Press Cancel to quit and return to Start menu. 	 <p>MARK101</p>  <p>MARK103</p>
<p>STEP 2: Select your desired probe type.</p> <p>NOTE: Use the same probes for the following: TR2500 for TR2500A, TR2510 for TR2510A, TR2520 for TR2520A.</p> <ul style="list-style-type: none"> • If the current probe that you are using is not on the list, select Other. Then press Scale to define the CT scale factor on the current probe. Proceed to Step 3 on page 5-9. 	 <p>MARK104</p>

Continued on next page

Selecting current probe (continued)

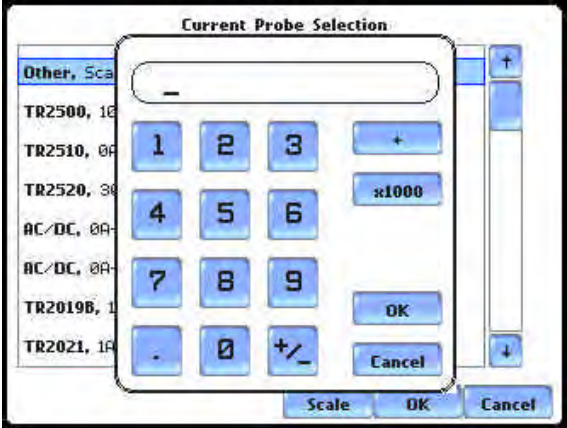
Action...	Result...
<p>STEP 2: (continued)</p> <ul style="list-style-type: none"> Press OK to accept probe selection and monitor current. Press Cancel to retain previous probe settings and return to previous screen. 	
<p>STEP 3: You need to set the CT scale factor when using a current probe that is not on the list. Pressing Scale will show the numeric window to enter the CT scale factor on the current probe. Use the keypad to set the CT scale factor. See sample scale factor calculation on page 5-10.</p> <ul style="list-style-type: none"> Press OK to accept the CT scale factor value. The screen shown in Step 2 will be displayed. Press ← if you want to clear and retype numeric values. Press x1000 to multiply the value by 1000. Press Cancel to discard changes and return to the previous screen (screen shown on Step 2). 	 <p>MARK104B</p>

Other relevant information on current probes

Refer to Chapter 2 Voltage Measurement Cable and Current Probe Connections for illustrations of typical current probes and for guidelines on how to connect current probes.

Refer to Appendix A for descriptions and part numbers of probes and adapter cables.

Refer to Appendix B for Dranetz-BMI current probes technical specifications.

Scale Factor Setup

What is a scale factor?

A scale factor is the ratio of the input to output for a particular current transformer (CT) or potential transformer (PT). A scale factor is entered in the unit and then multiplied automatically by the measured voltage or current so the unit displays the correct values, as referenced to the primary side, rather than the secondary side of the PT or CT.

NOTE: If voltage and current connections are made without using any of the above named devices, the scale factor should be set to 1.

When to use

Scale factors must be entered for the following conditions:

- A Dranetz-BMI current probe is connected to a permanently installed CT.
- The current connections are made using a Dranetz-BMI ISO box.
- The voltage connections are made using a PT.

Non-Dranetz equipment

Refer to the CT name plate or to the manufacturer's literature to determine the scale factor.

Sample calculation

The scale factor for a single CT or PT is calculated from its step-up or step-down ratio.

Example of step-down ratio

If a current transformer has a step-down ratio of 1000A:5A, therefore:
Scale Factor = $1000/5 = 200$

Example of step-up ratio

If a potential transformer has a step-up ratio of 1V:10V, therefore:
Scale Factor = $1/10 = 0.1$

Scale factor setup screen

After setting up current probe configurations, the Scale Factor screen is displayed.

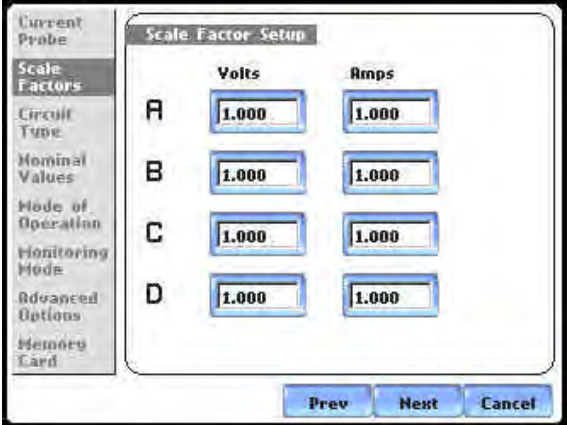
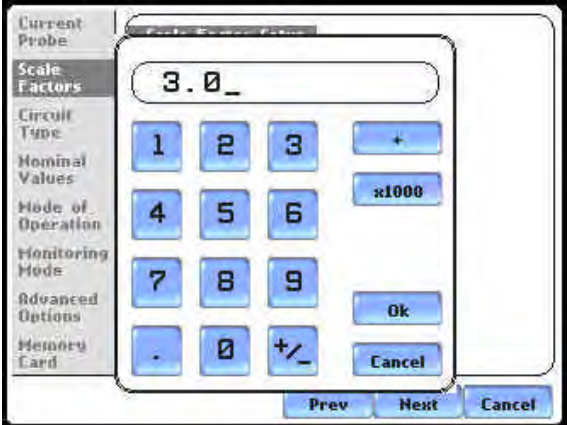
Action...	Result...
<p>STEP 1: From the Current Probe Selection screen, press Next to display the Scale Factor Setup.</p> <ul style="list-style-type: none"> • If voltage and current connections are made without using any current or potential transformer devices, the scale factor is set to the default value of 1. Press Next and go to page 5-11. • To enter new scale factors, press the numeric field of the Volts/Amps channel where you want to enter new scale factors. Proceed to Step 2. • Press Cancel to quit and return to Start menu. 	 <p>MARK105</p>
<p>STEP 2: Enter a new scale factor value using the numeric keypad. Press OK to accept the new scale factor.</p> <ul style="list-style-type: none"> • Press ← to clear and retype numeric values. • Press x1000 to multiply the value by 1000. • Press Cancel to discard changes and retain previous scale factor value, and return to Scale Factor Setup screen. 	 <p>MARK105B</p>

Circuit Type Selection

Circuit setup

The PowerVisa is able to display wiring diagrams from which users can select the circuit type appropriate to their application. The instrument will display the detected circuit configuration and compare the detected voltages, currents, and phase sequence (if applicable) to the selected circuit type. Refer to Appendix E for the descriptions of common circuit connections.

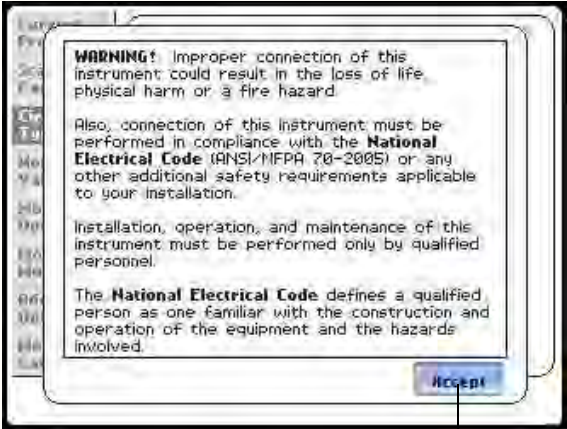
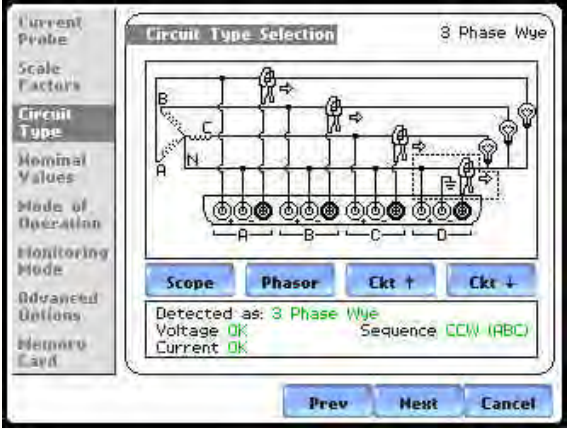
Action...	Result...
<p>STEP 1: From the Scale Factor Setup screen, press Next to display Circuit Type Selection. Read the Warning advisory, then press Accept to display the menus for circuit selection.</p> <ul style="list-style-type: none"> To select a circuit configuration, press the Ckt arrow keys until the desired configuration is displayed. <p>An auto circuit detection window is displayed to show if selected circuit type and the detected voltages, currents, and phase sequence match (text in green) or do not match (text in red).</p> <p>When done with Circuit setup, press Next. Go to page 5-14.</p> <ul style="list-style-type: none"> Real-time Scope and Phasor screens are available. These functions help verify if the wiring configuration matches the circuit being monitored. Press Scope to check if the waveforms look correct for the specified wiring setup. Proceed to Step 2 on page 5-13. Press Phasor to view if phasor display match those expected from the specified wiring diagram. Proceed to Step 3 on page 5-13. Press Cancel to discard changes and return to Start menu. 	 <p style="text-align: right;">MARK107</p>  <p style="text-align: right;">MARK108</p>

**Circuit Setup
(continued)**

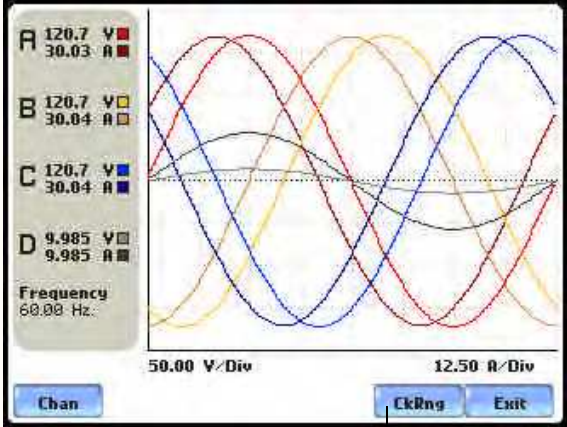
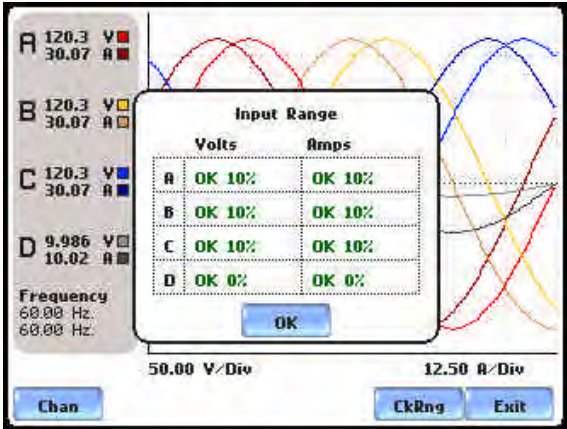
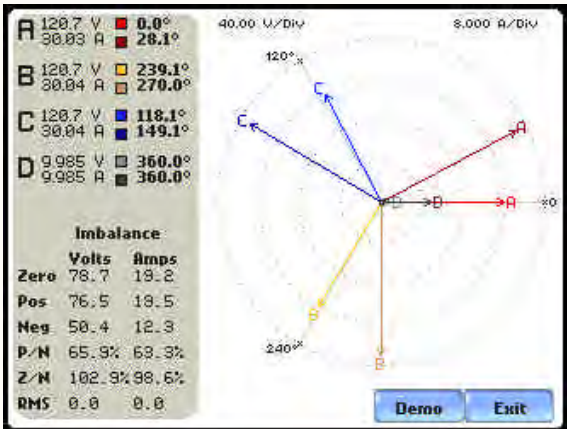
Action...	Result...												
<p>STEP 2: Scope mode allows users to verify if waveforms look correct for the specified wiring setup.</p> <ul style="list-style-type: none"> To check input range, press CkRng. The Input Range screen displays the detected range for voltage and current channels A, B, C, and D. The instrument registers a message on the Input Range screen that corresponds to the detected input range for each channel: <table border="1"> <thead> <tr> <th><u>Input Range</u></th> <th><u>Description</u></th> </tr> </thead> <tbody> <tr> <td>OK</td> <td>Within Range</td> </tr> <tr> <td>OVER</td> <td>Over Range</td> </tr> <tr> <td>UNDER</td> <td>Under Range</td> </tr> <tr> <td>N/A</td> <td>Channel Disabled</td> </tr> <tr> <td>CLIP</td> <td>Clipping</td> </tr> </tbody> </table> <ul style="list-style-type: none"> When done checking the input range, press OK to return to the Scope mode screen. Once in Scope mode screen, press Exit to return to Circuit Type Selection screen. 	<u>Input Range</u>	<u>Description</u>	OK	Within Range	OVER	Over Range	UNDER	Under Range	N/A	Channel Disabled	CLIP	Clipping	 <p>MARK201</p>  <p>MARK205</p>
<u>Input Range</u>	<u>Description</u>												
OK	Within Range												
OVER	Over Range												
UNDER	Under Range												
N/A	Channel Disabled												
CLIP	Clipping												
<p>STEP 3: Phasor display shows a graph that indicates phase relations between voltage and current.</p> <p>For more information on phasors, refer to Chapter 3 View Real Time Data - Section D Voltage and Current Phasor.</p> <ul style="list-style-type: none"> Press Demo to show animated phasor rotations. Press Exit to return to Circuit Type Selection screen. 	 <p>MARK241</p>												

Nominal Values

Frequency, voltage and current settings

The Nominal Values screen allows users to enter values for frequency nominal line voltage and current, or use the computed nominal values displayed on screen.

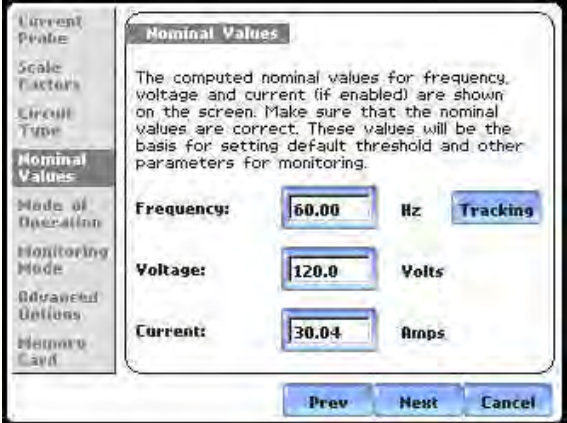
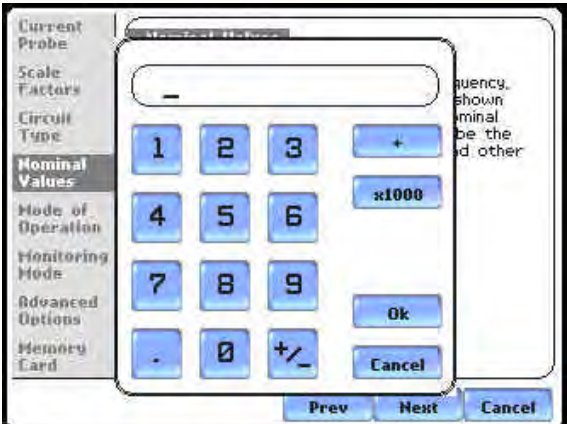
Action...	Result...
<p>STEP 1: Nominal Values screen appears as users prepare the instrument to record data. From the Circuit Type Selection screen, press Next to display Nominal Values.</p> <ul style="list-style-type: none"> • If the computed nominal values are accepted without change, press Next. Go to page 5-16. • To enter a new nominal Frequency, Voltage and/or Current value, press the corresponding button and proceed to Step 2. • To set the properties to track frequency of a monitored system, press Tracking. Proceed to Step 3 on page 5-14. • Press Cancel to quit and return to Start menu. 	 <p>NOTE: Make sure that the nominal values computed by the PowerVisa are correct. Nominal values are used as basis for setting default thresholds and other parameters for circuit monitoring.</p>
<p>STEP 2: Enter a new nominal Frequency/Voltage/Current value using the numeric keypad. Press OK to accept the new value.</p> <ul style="list-style-type: none"> • Press ← to clear and retype numeric values. • Press x1000 to multiply the value by 1000. • Press Cancel to retain previous nominal values and return to Nominal Values screen. 	

Continued on next page

**Frequency,
voltage and
current settings
(continued)**

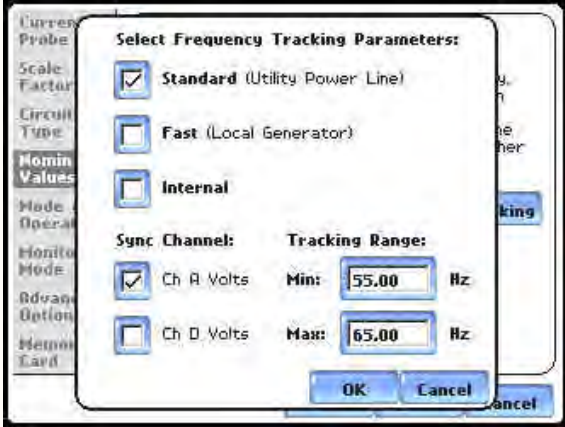
Action...	Result...
<p>STEP 3: Tracking allows users to set parameters to monitor changes in frequency.</p> <p><u>Voltage Class:</u> Check to select the power system that define the voltage range of distribution of the monitored system.</p> <ul style="list-style-type: none"> • Standard voltage range is 16- PowerVisa Hz. • Fast voltage range is 16-65 Hz. • Internal uses the nominal frequency when making measurements where no reference signal is available. <p>NOTE: Always enter a nominal frequency that matches your line frequency. This ensures that if the PowerVisa loses external sync, it will have a corresponding internal sync.</p> <p><u>Sync Channel:</u> Check to specify the external sync mode to show which channel the signal is connected to. See page 5-16 for more details on frequency synchronization.</p> <ul style="list-style-type: none"> • Ch A Volts: When set to Ch A, the PowerVisa attempts to sync to an incoming voltage signal. • Ch D Volts: When set to Ch D, the PowerVisa only attempts to sync to voltage Ch D. <p><u>Tracking Range:</u> The Min and Max refer to the range of frequencies that the phase locked loop will “hunt” if sync is lost. See page 5-16 for more details on frequency tracking.</p> <ul style="list-style-type: none"> • Press OK to accept new frequency tracking settings. • Press Cancel to quit and return to Nominal Values screen. 	 <p>MARK110c</p>

Frequency synchronization

Normal frequency synchronization (sync) of the PowerVisa analog signal processing circuits is controlled by analyzing the external AC voltage signal input on channel A. Loss of external sync causes the PowerVisa to poll other valid voltage channels (A, B, or C) for an alternate external sync. If none exists, then internal sync is automatically selected. The frequency used for internal is entered under Frequency on the Nominal Values screen (see page 5-14).

Depending on the type of circuit configuration, the instrument will attempt to autosearch to sync to any valid voltage channel. The autosearch function will be disabled when users specify sync mode Ch D Volts. Typically, external sync on Ch D is specified if it is known that signals on A, B or C are inappropriate for use as a sync source (i.e. the frequency is unstable or DC). A low distortion 50, 60 or 400 Hz signal can be input to Ch D and used as a sync signal.

NOTE: Failure to connect an external sync or to select an internal sync during current monitoring will result in erroneous data being collected and displayed.

Frequency Tracking

Tracking determines how the phase locked loop circuitry responds to sudden changes in frequency.

Standard mode: On a normal power quality application [Standard], the system is designed to “ride through” voltage changes to keep tracking the fundamental frequency even in the absence of voltage.

Fast mode: When operating on a local generator [Fast], the frequency will vary more as loading changes occur. The Fast mode allows the instrument to follow these changes more closely.

Internal mode: In cases where no reference signal is available (such as DC monitoring), the Internal setting is used to set the sample rate.

Mode of Operation

Basic meter setup

After entering the correct nominal values for circuit monitoring, users have the option to set the instrument to record data or use the instrument as a meter.

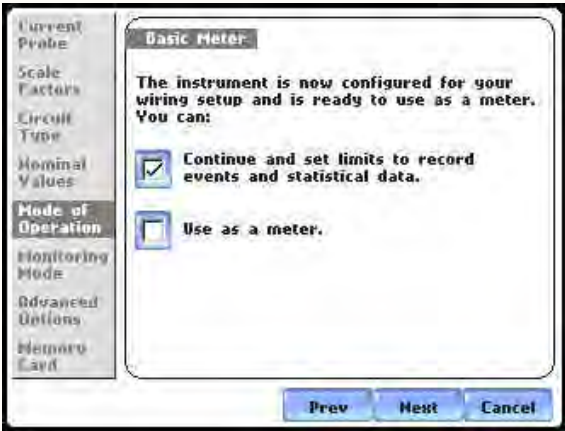
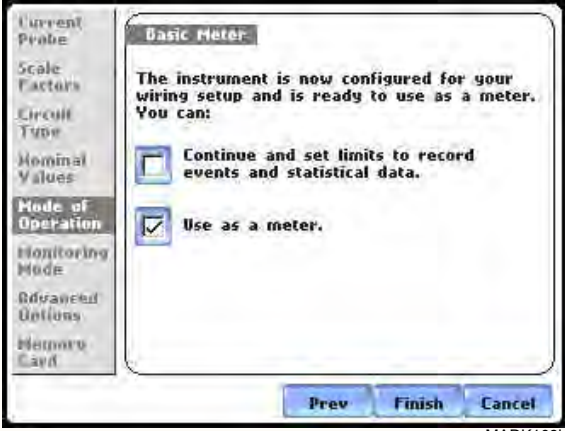
Action...	Result...
<p>STEP 1: From the Frequency Tracking screen, press Next to display the Mode of Operation.</p> <ul style="list-style-type: none"> To set up the instrument to record data, press to enable Continue and set limits to record events and statistical data. Press Next and go to page 5-18. To use the instrument as a meter, press to enable Use as a meter. Proceed to Step 2. Press Cancel to discard changes and return to Start menu. 	 <p>MARK109</p>
<p>STEP 2: The instrument is now configured for your specified wiring setup and is ready to use as a meter.</p> <ul style="list-style-type: none"> Press Finish to begin using instrument as a meter and return to Home screen. Press Cancel to discard meter mode operation and return to Start menu. 	 <p>MARK109b</p>

Monitoring Mode

Choose a monitoring mode

The PowerVisa provides four monitoring modes of operation from which to monitor and capture data relevant to user application.

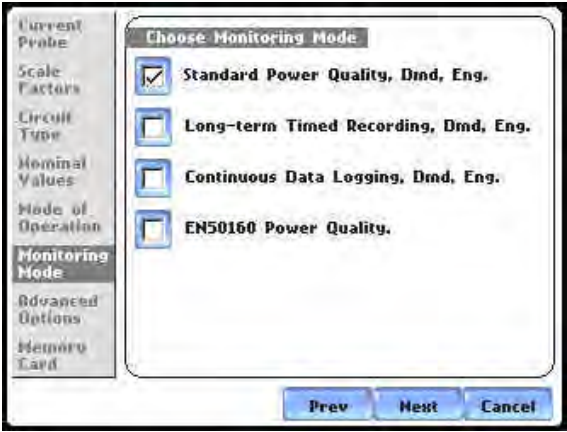
Action...	Result...
<p>STEP 1: From the Basic Meter screen, press Next to display the different Monitoring Mode setups.</p> <ul style="list-style-type: none"> • Check to select your desired monitoring mode setup. Press Next and go to page 5-19. • Press Cancel to quit and return to Start menu. 	

Monitoring mode descriptions

Standard Power Quality, Demand, Energy optimizes the instrument to collect data for troubleshooting using standard power quality parameters, with numerous trigger conditions set.

Long-term Timed Recording, Demand, Energy sets the instrument to use periodic measurements only. This setting is used for long-term statistical studies and benchmarking field-based equipment testing and evaluation. No triggers are set so only trended values are available.

Continuous Data Logging, Demand, Energy sets the instrument to log rms and power values once per second until memory is filled or for specified time period.

EN50160 Power Quality monitors and reports Quality of Supply (QOS) compliance as specified by the EN50160 standard. A full discussion on EN50160 is found on Chapter 8 Reports.



NOTE

Users can override the default settings to customize the instrument to their application. For the default settings of parameters in each monitoring mode, see Appendix B Technical Specifications - Parameter Settings in Each Monitoring Mode on page B-10.

Advanced Options

Advanced setup options

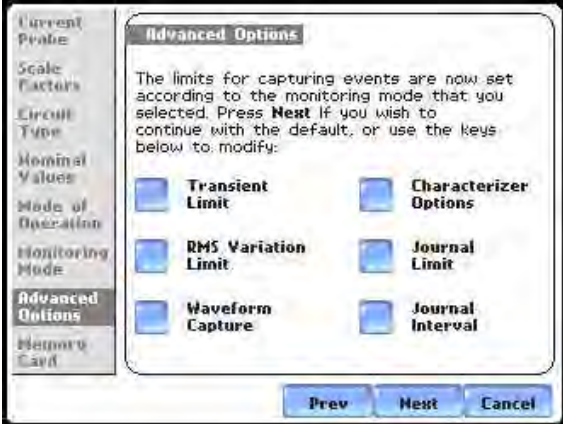
After selecting a monitoring mode, the system is now ready to begin monitoring and to record data in card. Prior to actual monitoring, users have the option to accept the default threshold settings and proceed with monitoring, or to review and/or modify monitoring settings.

Action...	Result...
<p>STEP 1: From the Choose Monitoring Mode screen, select monitoring mode, then press Next to display Advanced Options.</p> <ul style="list-style-type: none"> If the default settings for the specified monitoring mode are acceptable without change, press Next. Go to page 5-20. To review and/or modify default threshold settings, press the desired parameter on screen. Go to Chapter 6 Advanced Setup Options. Press Cancel to quit and return to Start menu. 	<p>The following screen will appear if the selected monitoring mode is non-EN50160:</p>  <p style="text-align: right;">MARK112</p>
	<p>The following screen will appear if the selected monitoring mode is EN50160 Power Quality:</p>  <p style="text-align: right;">MARK112B</p>

See Chapter 6 Advanced Setup Options for a detailed discussion of each threshold parameter displayed in the Advanced Options screen.

Site Name/Memory Card

Where you can save data

PowerVisa uses the Compact Flash data card as primary storage for data. It automatically saves data in the card when monitoring is on. The Compact Flash card must be installed in either data card Slot 1 or Slot 2 in order to record data.

NOTE: Although the unit is able to detect availability of data card in either slot, Dranetz-BMI strongly recommends the use of only one card slot (one data card) at a time.

Data card size

PowerVisa requires a Compact Flash data card with minimum storage capacity of 32MB, maximum of 128MB. See Appendix A Optional Accessories for the part numbers of Compact Flash cards supplied by Dranetz-BMI.

NOTE: Dranetz-BMI Compact Flash data cards have been tested to work properly with PowerVisa. Non-Dranetz-BMI Compact Flash cards may not be compatible with the instrument and cannot be supported by Dranetz-BMI Customer Service in case problems arise. Users are advised to use only Dranetz-BMI parts and accessories.

Filename

The following files are created on the data card: *filename.set* for setups template and *filename.ddb* for saved events. The maximum allowable length for a site/file name is 32 characters.

Data card screen

Before monitoring begins, the Site Name/Memory Card screen is displayed. The screen reports the current operational status of the data card.

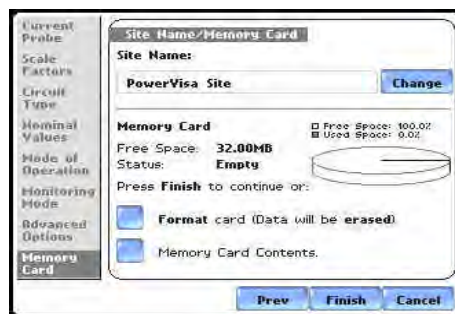

VISA113

Data card status messages

The following messages may appear in the data card status line.

Status Message	Description
Not Inserted	Data card not inserted or not detected. Insert a valid data card to proceed.
Empty	Data card is empty.
Contains File	Data card presently contains files.

Data card status messages (continued)

Status Message	Description
Fragmented	A fragmented FAT was detected. Monitoring cannot proceed with a fragmented data card. Either change the data card or format to continue.
Unformatted	Data card is not formatted. Format the data card or replace with a different card to continue.
Invalid Card	Data card is not valid for monitoring. Change the data card to proceed.

Data card operation

The data card screen prompts users to set filename and format card in preparation for monitoring and writing of data.

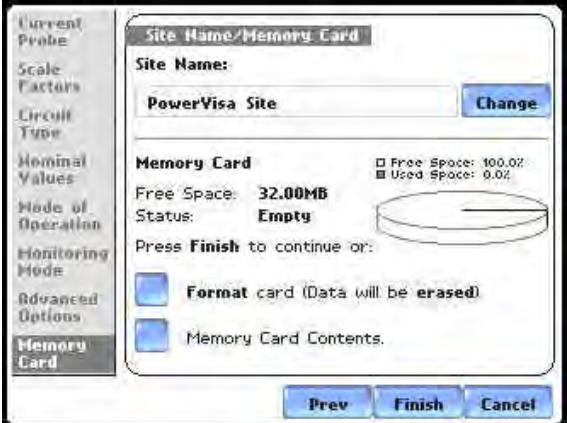
Action...	Result...
<p>STEP 1: From the Advanced Options screen, press Next to display data card status.</p> <ul style="list-style-type: none"> If the default filename is acceptable without change, and if the card is formatted to save data, press Finish. The system is ready to begin monitoring. Go to Section B Monitor Same Circuit - Turning Monitoring On/Off on page 5-24. Press Change to enter a new site/file name. Proceed to Step 2 on page 5-22. Press Format card to format the data card. <p>NOTE: All data and setups stored in data card will be lost when you format the card. Copy any files that you want to save to a computer first before formatting card.</p> <ul style="list-style-type: none"> Press Memory Card Contents to view list of data files stored in card. Press Cancel to discard changes and return to Start Menu. 	

Continued on next page

Data card operation (continued)

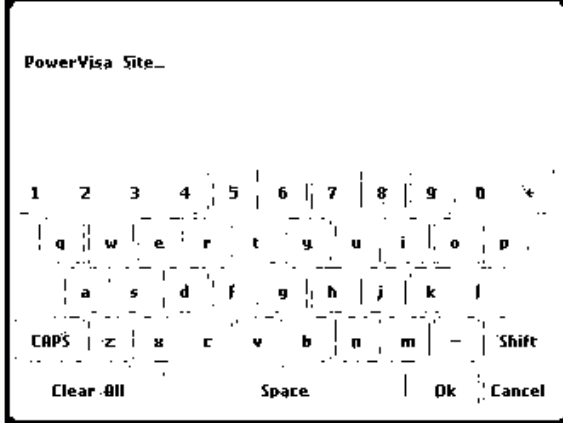
Action...	Result...
<p>STEP 2: Enter a new site/file name using the onscreen keyboard. Press OK to accept the new site/file name.</p> <ul style="list-style-type: none"> • Press Shift to enter a character in uppercase. • Press CAPS to enter all characters in uppercase. • Press Space to enter a space in between characters. • Press Clear All to delete the entire name on the space provided. • Press ← to erase a character. • Press Cancel to retain the default site/file name and return to Site Name/Memory Card screen. 	

Writing setup template to data card

Saving setups template means writing current configurations and threshold setups to the data card. Configurations and setups include the following:

- Present circuit type
- Present scale factors
- Thresholds
- Waveform capture settings
- Interval for timed readings
- Site name

NOTE: The filename extension for the setup template is SET, i.e. *filename.set*.

**Guidelines on
file data transfer**

The PowerVisa treats the Compact Flash card like a hard disk storing files in DOS format. For successful card data transfer, keep the following points in mind:

- PowerVisa supports a maximum DOS directory size of 128MB. Minimum required Compact Flash data card size is 32MB.
 - Compact Flash cards allow users to store multiple files in one card. The Site name will be used as the filename for record files (i.e. if the site name is PowerVisa Site, the filename will be PowerVisa Site 00.DDB). A number is automatically appended to the name such that filenames are automatically incremented every time the user starts monitoring with that same filename.
 - PowerVisa does not support file fragmentation. When creating a file, it will take the largest contiguous block and use that size block for data storage. Deleting files from the memory card is **NOT RECOMMENDED**. When there is no more space available to begin new data storage, reformat the card using the PowerVisa, after transferring data files to a computer.
-

Section C

Monitor Same Circuit

Overview

Introduction

Menu options for monitoring become available only after setting up the instrument or from reading a setup template from the data card. Users can monitor the same circuit, and configure combinations of setups unique to their task applications.

Monitoring options

Users have the option to begin monitoring immediately or at a specified time and date. The Monitoring Menu also allows users to do Advanced setups via the Modify Trigger Parameters and Intervals option. Unlike the Automatic and Wizard setup procedures, Advanced setup allows users to change parameters and enter new limits to capture events. A full discussion on modifying threshold settings is found in Chapter 6 Advanced Setup Options.

In this section

The following topics are covered in this section.

Topic	See Page
Turning Monitoring On/Off	5-25
Monitoring at a Specified Time and Date	5-28
Modify Trigger Parameters and Intervals	5-32

Turning Monitoring On/Off

Start/Stop monitoring

Follow these steps to start and end monitoring.

Action...	Result...
<p>STEP 1: From the Automatic Setup screen, press OK to start monitoring (see page 5-3). The Monitoring Menu screen will be displayed.</p> <p>OR</p> <p>STEP 1: From the Start Menu screen (see page 5-2), press Monitor Same Circuit.</p> <p>NOTE: Monitoring Menu screen will only be available after setting up the instrument or from reading a setup template from card.</p> <p>OR</p> <p>STEP 1: At the end of the Wizard Setup, the Site Name/Memory Card screen prompts users to press Finish so as to start monitoring (see page 5-21). The Monitoring Menu screen will be displayed.</p> <ul style="list-style-type: none"> • To start monitoring, press Start Now!. Proceed to Step 2 on page 5-26. • To set monitoring at a specified date and time, press Monitor using Start and End times. Go to page 5-28. • To modify parameter settings, press Modify Trigger Parameters and Intervals. Proceed to page 5-32. • To review the present setups, press View Setup Summary. Proceed to Step 5 on page 5-27. • Press Save Setup Template to Card to write setups to card as template for future use. • Press Exit to cancel and return to Home screen. 	

Start/Stop monitoring (continued)

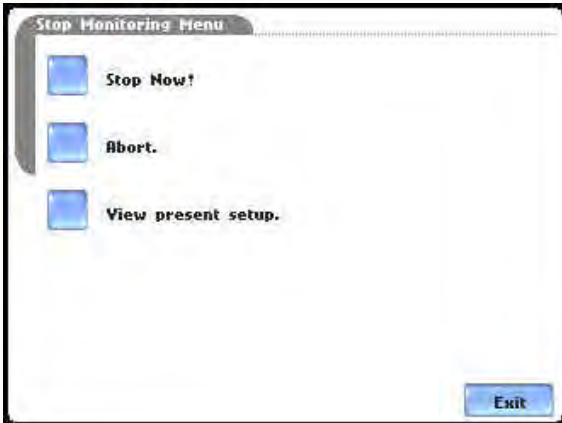
Action...	Result...
<p>STEP 2: While the instrument is actively monitoring data, the message MONITORING STATUS: ON appears on the top section of the Home screen (see NOTE).</p> <p>Users cannot change the time and date nor perform data card operations while the instrument is actively monitoring data. However, the rest of the function keys, including date style and clock style, are operable even while monitoring status is ON.</p> <ul style="list-style-type: none"> To end monitoring, press Stop. Proceed to Step 3. 	 <p>The screenshot shows the PowerVisa Home screen with the following information: <ul style="list-style-type: none"> MONITORING STATUS: ON START TIME: 20:31:46, Dec 20 04 CIRCUIT TYPE: 3 Phase Wye MEMORY CARD: 32.00 MB free FILENAME: PowerVisa Site EVENTS SAVED: 0 JOURNALS LOGGED: 40 The screen features several function keys: Scope, Meter, Harmonics, Phasor, Trend, Events, Reports, and Preferences. A blue STOP button is located at the bottom center. The date and time are displayed in the top right corner as Dec 20 04. <p style="text-align: right;">PVISA122</p> <p>NOTE: The following status messages are displayed after monitoring is turned on.</p> <p>MONITORING STATUS: ON (monitoring will continue until Stop is pressed or when specified end time is reached; START TIME and date are displayed while monitoring is on)</p> <p>CIRCUIT TYPE: xxxxxx (default or user specified)</p> <p>MEMORY CARD: x% (remaining space in the data card in percent)</p> <p>FILENAME: User specified or PowerVisa Site xx..ddb (where xx increments every time data is saved using the same file name)</p> <p>EVENTS SAVED: xx (counter on the number of events saved to the data card; CYCLES SAVED appears instead of Events Saved if characterizer is set to None (Raw Data) - see page 6-15)</p> <p>JOURNALS LOGGED: xx (counter on the number of timed readings recorded)</p> </p>
<p>STEP 3: Stop Monitoring Menu confirms whether users want to end monitoring, cancel monitoring, or view present setups.</p> <ul style="list-style-type: none"> To turn monitoring off, press Stop Now! This will save any pending data and close the file. Proceed to Step 4 on page 5-27. To cancel monitoring, press Abort. All data collected will be lost when monitoring is aborted. To view setups, press View present setup. This will not save any monitoring parameters. Proceed to Step 5 on page 5-27. To continue monitoring, press Exit. 	 <p>The screenshot shows the Stop Monitoring Menu with three options: Stop Now!, Abort, and View present setup. An Exit button is located at the bottom right corner. <p style="text-align: right;">MARK123</p> </p>

Start/Stop monitoring (continued)

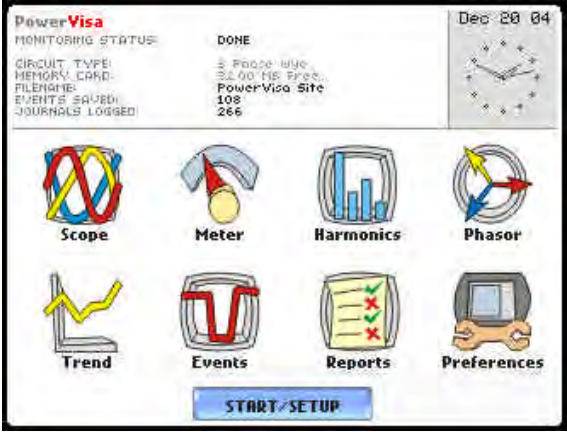
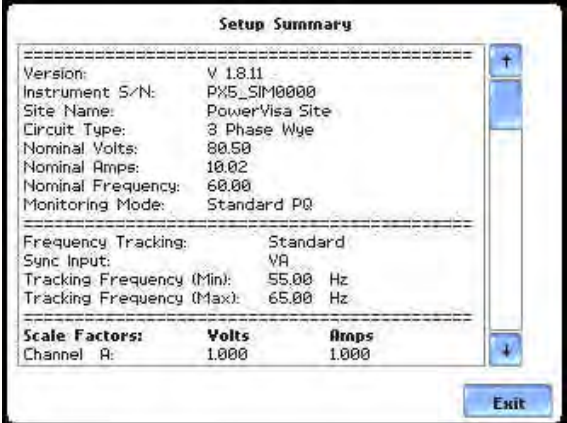
Action...	Result...
<p>STEP 4: When monitoring ends, the message MONITORING STATUS: DONE appears on screen (see NOTES).</p> <ul style="list-style-type: none"> To capture a new set of data or to edit threshold settings, press Start. The Start Menu screen will be displayed. Go to page 5-2. To view recorded data, press Trend, Events, or Reports. Go to Chapter 7 View Event Data. 	 <p style="text-align: right;">PVISA124</p> <p>NOTE 1: The message MONITORING STATUS: DONE appears to indicate that monitoring is completed and active recording is disabled.</p> <p>NOTE 2: The Events button will display data if periodic measurements at regular intervals are available or if thresholds have been crossed. See Chapter 7 View Event Data.</p>
<p>STEP 5: Press View present setup to display the parameter settings in effect. Setup summary is available for review before, during, and after monitoring.</p> <ul style="list-style-type: none"> Press Up/Down arrow keys to scroll the page up or down by one line. Press and drag the scroll bar to move the page up or down. When done reviewing the Setup Summary, press Exit. The screen will return to the Stop Monitoring Menu options on page 5-26. 	 <p style="text-align: right;">VISA123</p>

Monitoring at a Specified Time and Date

Schedule monitoring

Follow these steps to set monitoring at a specified time and date.

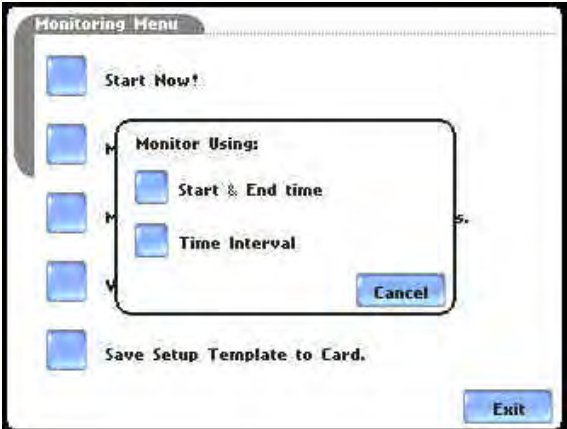
Action...	Result...
<p>STEP 1: From the Automatic Setup screen, press OK to start monitoring (see page 5-3). The Monitoring Menu screen will be displayed.</p> <p>OR</p> <p>STEP 1: From the Start Menu screen (see page 5-2), press Monitor Same Circuit.</p> <p>NOTE: The Monitoring Menu screen will only be available after setting up the instrument or from reading a setup template from the memory card.</p> <p>OR</p> <p>STEP 1: At the end of the Wizard Setup, the Site Name/Memory Card screen prompts users to press Finish so as to start monitoring (see page 5-21). The Monitoring Menu screen will be displayed.</p> <ul style="list-style-type: none"> To set monitoring at a specified date and time, press Monitor using Start and End times. Proceed to Step 2. <p>For functional descriptions of the other buttons, refer to Section C Monitor Same Circuit - Turning Monitoring On/Off on page 5-25.</p>	 <p>MARK121</p>
<p>STEP 2: The PowerVisa will monitor and collect data using either of the following monitoring schedules:</p> <ul style="list-style-type: none"> Press Start & End time to specify the date/time when the unit will begin and end monitoring. See page 5-29. Press Time Interval to specify the length of the recording interval for each file, and the time/date to start monitoring interval. See page 5-32. Press Cancel to quit and return to the monitoring menu. 	 <p>MARK125a</p>

Monitoring using start & end time

You can specify the date and time when the unit will begin and end monitoring.

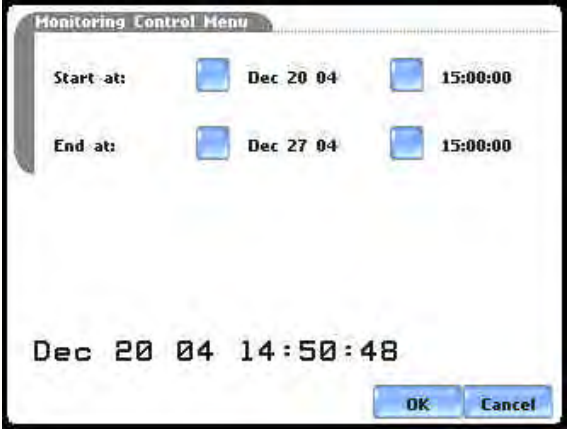
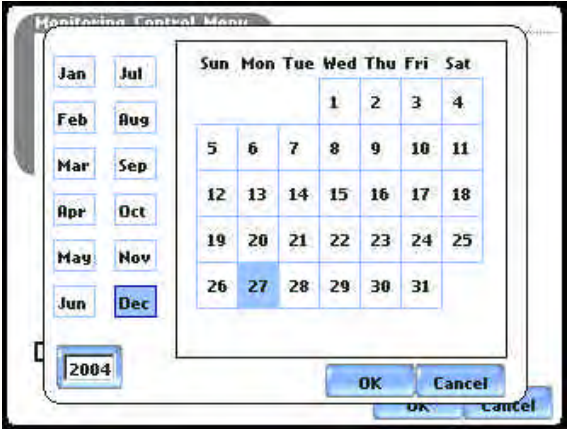
Action...	Result...
<p>STEP 1: When monitoring using the Start & End time schedule, the current date and time (set to the next full hour) are displayed on screen.</p> <ul style="list-style-type: none"> • Start at: indicates the date and time when the unit will begin data monitoring. • End at: indicates the date and time when the unit will stop data monitoring. <p>By default, the system will automatically end monitoring one week from the time/date monitoring starts. However, users are allowed to specify their own time/date when they want to stop monitoring.</p> <p><u>For example:</u> Set monitoring to - Start at: Oct. 27, 2004; 12:00:00 End at: Nov. 3, 2004; 12:30:00 Press the End at: Date and Time keys and proceed to Step 2.</p> <ul style="list-style-type: none"> • Press OK to accept the settings and return to Home screen. • Press Cancel to retain previous monitoring settings and return to Home screen. 	 <p>VISA125</p>
<p>STEP 2: Use the Date and Time function keys to set when monitoring will start and end.</p> <ul style="list-style-type: none"> • Press Date to enter desired month-day-year to start/end monitoring. Use the numeric keypad to enter the year. • Press OK to accept changes in date settings. Continue with Step 2 on page 5-30. • Press Cancel to discard changes in date and return to Monitoring Control Menu. 	 <p>VISA126</p>

Continued on next page

Monitoring using start & end time (continued)

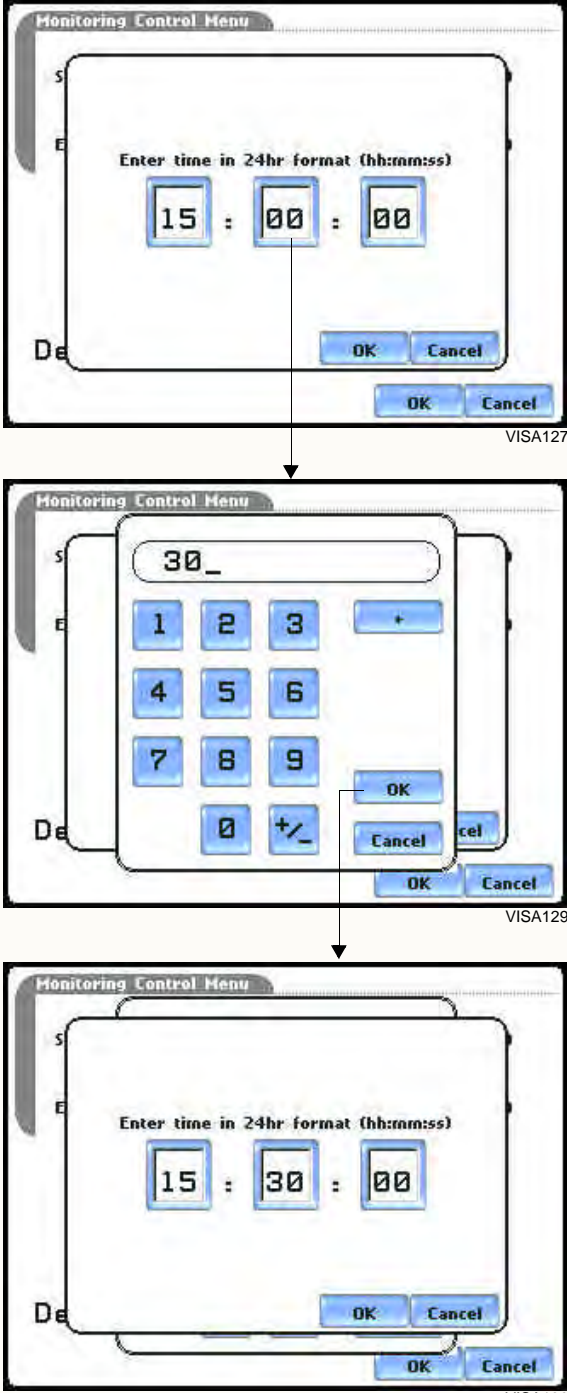
Action...	Result...
<p>STEP 2 (continued):</p> <ul style="list-style-type: none"> • Press Time to enter desired hour-minute-second to start/end monitoring. Press to select the hour/minute/second field to display the numeric keypad. Use the keypad to enter time settings. • Press OK to accept changes in time settings. Proceed to Step 3 on page 5-31. • Press Cancel to discard changes in time and return to Monitoring Control Menu. 	 <p>The result column contains three sequential screenshots of the 'Monitoring Control Menu' interface. The first screenshot (VISA127) shows the menu with the prompt 'Enter time in 24hr format (hh:mm:ss)' and the time '15 : 00 : 00'. The hour field is highlighted. The second screenshot (VISA128) shows the same menu with a numeric keypad overlaid. The number '30' is entered in the minute field, and the cursor is at the end of the input. The third screenshot (VISA130) shows the menu with the time updated to '15 : 30 : 00'.</p>

Continued on next page

Monitoring using start & end time (continued)

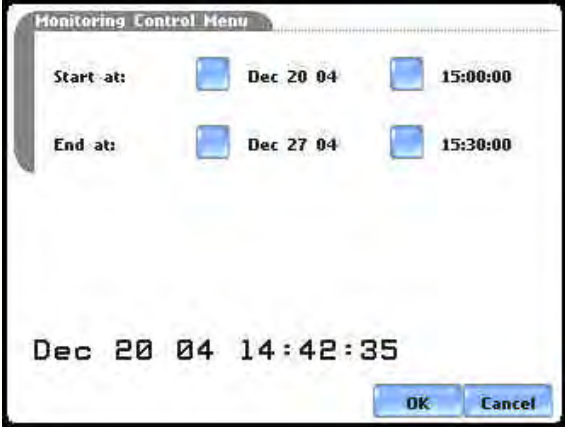
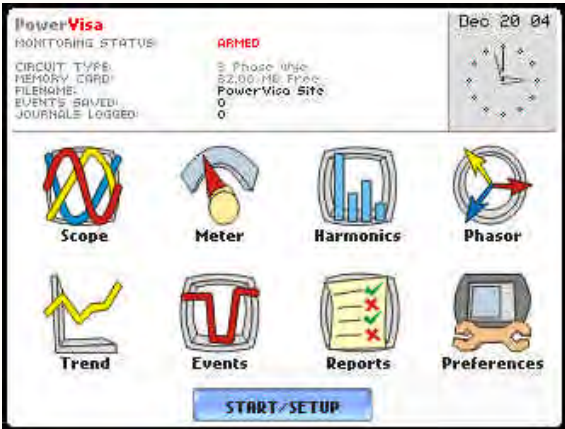
Action...	Result...
<p>STEP 3: The screen will display the new settings once the monitoring Start time/date and End time/date have been set.</p> <ul style="list-style-type: none"> • Press the time and date function keys when you want to change time/date monitoring settings. Refer back to Step 2 on page 5-29. • Press OK when done setting the Start and End monitoring time/date. Proceed to Step 5. • Press Cancel to discard the changes in time/date monitoring settings and return to Monitoring Menu. 	 <p>VISA131</p>
<p>STEP 4: After specifying the Start and End time/date of monitoring, the message MONITORING STATUS: ARMED appears on screen.</p> <p>Armed means that the system will automatically begin monitoring at the specified Start time and date.</p> <p>Once monitoring status is ON, follow the Start/Stop monitoring procedure found on page 5-26.</p>	 <p>PVISA132</p>

Monitoring at scheduled intervals

You can specify the date and time when the unit will begin monitoring, and choose from the following interval cycles when the unit will end recording and start a new file: daily, weekly, bi-weekly, or a customized number of days. Data monitoring will end when memory is full or when monitoring is stopped manually.

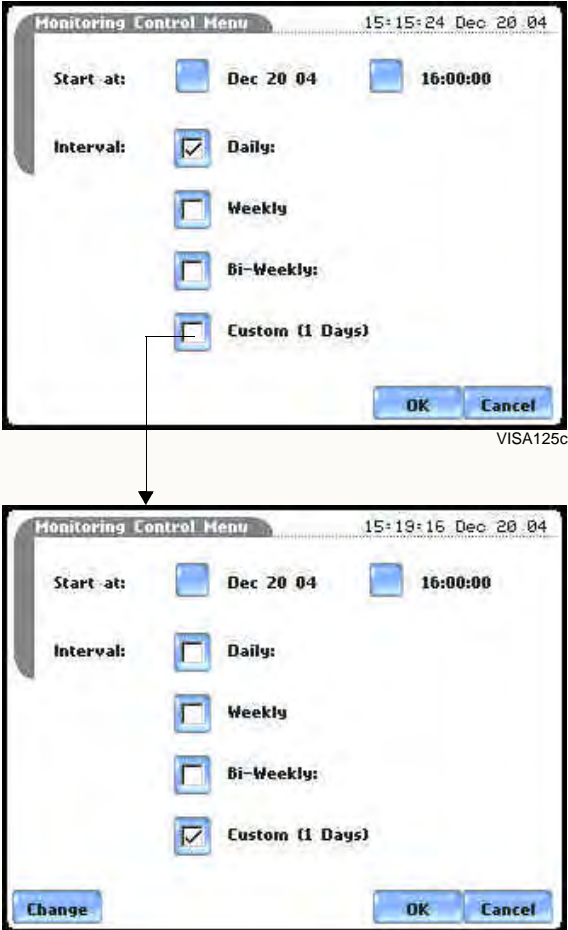
Action...	Result...
<p>STEP 1: When monitoring using Time Interval, the current date and time (set to the next full hour) are displayed on screen. Select the interval schedule on how often you want the unit to automatically end and start a new data file.</p> <ul style="list-style-type: none"> • Start at: Indicates the date and time when the unit will begin monitoring. • Interval: Indicates the time period when the unit will automatically collect and download event data. <ul style="list-style-type: none"> • Daily: Monitors data in 24-hour cycle and then starts a new file. The unit will append the filename for data collected every 24 hours. • Weekly: Monitors data in 7-day cycle and then starts a new file. The unit will append the filename for data collected every 7 days. • Bi-Weekly: Monitors data in 14-day cycle and then starts a new file. The unit will append the filename for data collected every 14 days. • Custom: The user specifies the time period (in days) when the unit will end recording interval. Press Change to set new time interval. • Press OK to accept the settings and return to Home screen. The message MONITORING STATUS: ARMED appears on screen. Armed means that the system will automatically begin monitoring at the specified Start time and date. • Press Cancel to retain previous monitoring settings and return to Home screen. 	 <p>The top screenshot, labeled VISA125c, shows the 'Monitoring Control Menu' with the 'Start at' field set to 'Dec 20 04' and '16:00:00'. Under the 'Interval:' section, the 'Daily' option is selected with a checked checkbox, while 'Weekly', 'Bi-Weekly', and 'Custom (1 Days)' are unselected. 'OK' and 'Cancel' buttons are at the bottom right.</p> <p>The bottom screenshot, labeled MARK125c, shows the same menu but with the 'Custom (1 Days)' option selected. A 'Change' button is now visible at the bottom left, and the 'OK' and 'Cancel' buttons remain at the bottom right. An arrow points from the 'Custom (1 Days)' option in the top screenshot to the 'Change' button in the bottom screenshot.</p>

Modify Trigger Parameters and Intervals

Advanced setups The Modify Trigger Parameters and Intervals screen allows users to turn on any available parameters and enter new threshold limits. Advanced Setup provides users wider control over all setup functions.

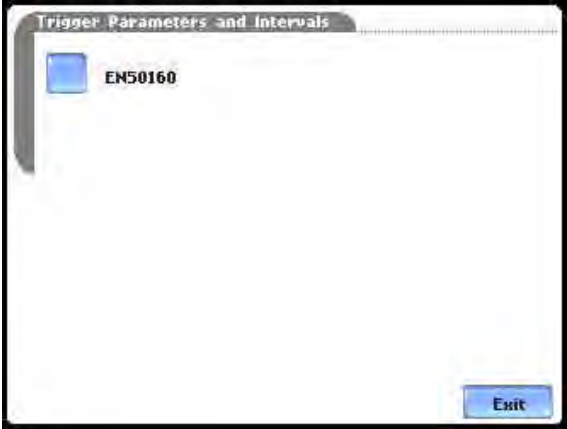
Action...	Result...
<p>STEP 1: From the Monitoring Menu screen, press Modify Trigger Parameters and Intervals.</p> <ul style="list-style-type: none"> Press the parameter whose default threshold settings you want to review and/or modify. Go to Chapter 6 Advanced Setup Options. <p>Press Site Name to set new filename prior to data monitoring. The onscreen keyboard will appear (see page 5-22 for instructions on how to use the keyboard).</p> <ul style="list-style-type: none"> Press Scale Factors to enter new scale factor values for Volts/Amps channels. The Scale Factor Setup screen will appear (see page 5-11 for instructions on how to enter a new scale factor value). Press Exit to quit and return to Monitoring Menu. 	<p>The following screen will appear if the selected monitoring mode is non-EN50160 (see page 5-17) :</p>  <p style="text-align: right; font-size: small;">MARK136</p> <p>The following screen will appear if the selected monitoring mode is EN50160 Power Quality (see page 5-18):</p>  <p style="text-align: right; font-size: small;">MARK137</p>

Refer to Chapter 6 Advanced Setup Options for a detailed discussion on modifying trigger parameters and intervals.

Section D

Load Setup Template from Card

Overview

Introduction

The PowerVisa enables users to load saved setup template files (.set) from the data card.

NOTE: Loading a setup template from the card will overwrite your existing setup.

Loading saved setups

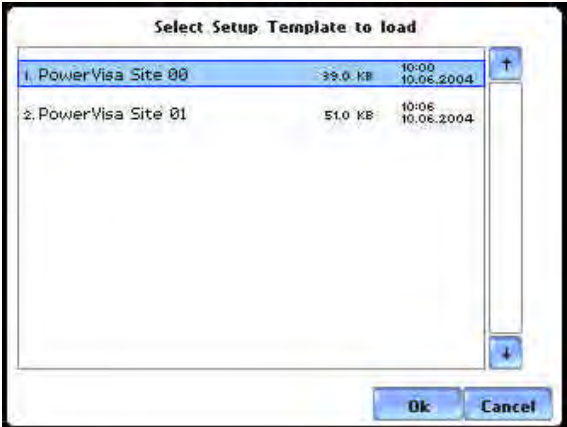
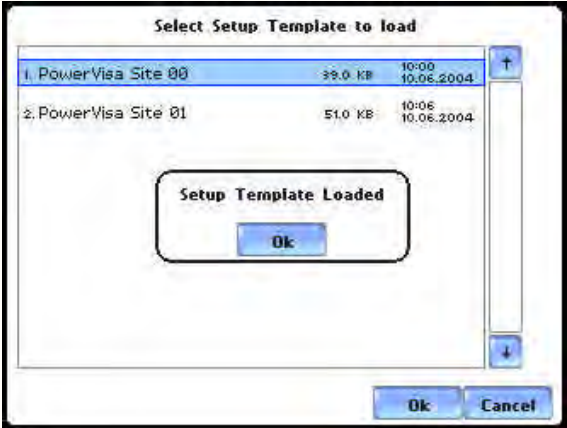
Action...	Result...
<p>STEP 1: From the Start Menu, press Load setup template from card. The PowerVisa lists the setup template files (.set) stored in data card, along with file size, time and date when the setup files were recorded. Setup files are arranged in the order of date and time they were recorded.</p> <ul style="list-style-type: none"> • Press Up/Down arrow keys to scroll the page up or down by one line. • Press to select (highlight) the desired setup template file. • Press OK to load setup template from card to the PowerVisa. Proceed to Step 2. • Press Cancel to quit and return to Start Menu. 	 <p style="text-align: right;">VISA138</p>
<p>STEP 2: The message Setup Template Loaded appears once the setup is successfully loaded from the data card to the PowerVisa.</p> <ul style="list-style-type: none"> • Press OK to exit. The Monitoring Menu screen will appear and users can begin monitoring. 	 <p style="text-align: right;">VISA139</p>

Section E

Load Data from Card

Overview

Introduction Data files (.ddb) consist of events that are saved to the data card while monitoring is on. The PowerVisa allows users to load stored data directly from card.

In this section The following topics are covered in this section.

Topic	See Page
Loading Data from Card	5-35
Card Error Messages	5-36

Loading data from card Follow these steps to load data from card.

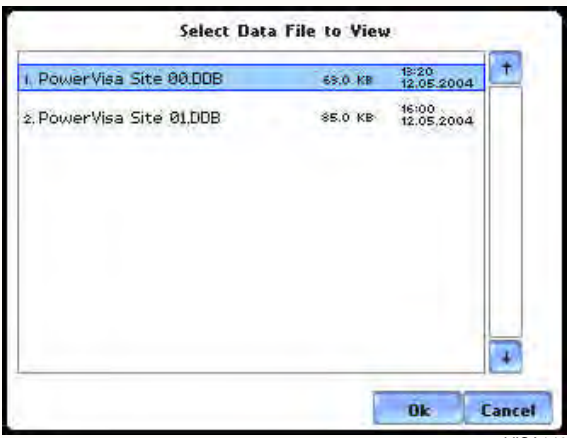
Action...	Result...
<p>STEP 1: From the Start Menu, press Load data from card. The PowerVisa lists the data files (.ddb) stored in card, along with file size, time and date when the data files were recorded. Data files are arranged in the order of date and time they were recorded.</p> <ul style="list-style-type: none"> • Press Up/Down arrow keys to scroll the page up or down by one line. • Press to select (highlight) the desired data file. • Press OK to load data from card to the PowerVisa and return to Home screen. • Press Cancel to quit and return to Start Menu. 	

NOTE If an error message is displayed, refer to Card Error Messages on page 5-36.

Card Error Messages

Error messages The following error messages may be displayed.

Error Message	Description
Card not inserted	No data card inserted or inserted improperly.
Card not ready	The Compact Flash data card controller is not ready. Try reinserting the data card.
Card read error	The data contains errors or the file has an invalid version.
No files on card	No valid data file on card.

CHAPTER 6



Advanced Setup Options

Overview

Introduction This chapter describes the options available to users with applications that require advanced setups. Although PowerVisa is designed to capture data no matter what the setup is, users are able to configure combinations of setups unique to their task applications.

Definitions Setup: A pre-set condition of parameter thresholds and waveform capture settings for each channel that determines what will constitute an event and what waveform data will be saved when this event occurs.

Event: An event occurs when a pre-set or programmed threshold is crossed. Events result in a contiguous collection of cycles that is saved into memory. An event consists of pre-trigger cycle(s), trigger cycle(s), and post-trigger cycle(s).

Parameter threshold: A value that the PowerVisa compares to a measurement to decide if an event occurs. Also called a limit. For example, if the input voltage is measured as 135 Vrms, and the parameter threshold for voltage is 132 Vrms, PowerVisa saves this limit crossing to memory as an event.

In this chapter This chapter covers the following topics:

Topic	See Page
Advanced Options Menu	6-2
Transient Limit	6-3
RMS Variation Limit	6-8
Waveform Capture	6-13
Characterizer Options	6-14
Journal Limit	6-15
Journal Interval for Timed Readings	6-18
EN50160 Power Quality (for strict EN50160 monitoring only)	6-20

Advanced Options Menu

Advanced menu settings Advanced Options lists the threshold parameters available for review or modification. The PowerVisa allows users to customize threshold settings according to their task applications.

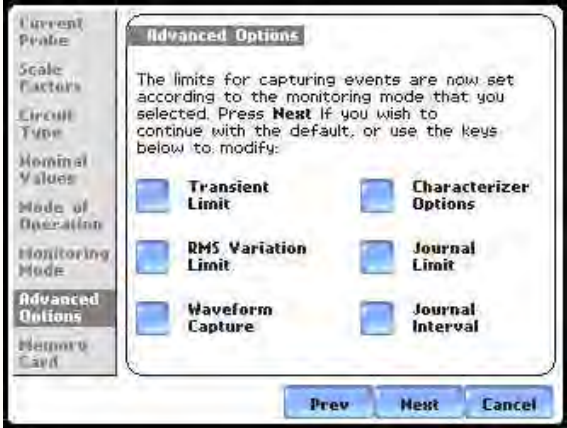
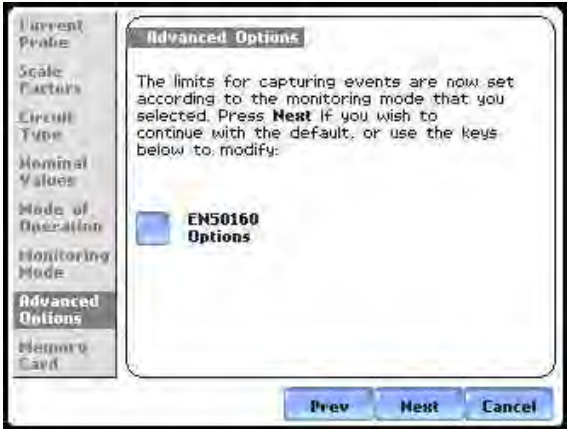
Action...	Result...
<p>STEP 1: From the Choose Monitoring Mode screen (see page 5-15), select monitoring mode, then press Next to display Advanced Options.</p> <ul style="list-style-type: none"> To review/modify limits for transient events, press Transient Limit. Go to page 6-3. To review/modify limits for rms variations, press RMS Variation Limit. Go to page 6-8. To review/modify trigger channels, press Waveform Capture. Go to page 6-13. To select event characterizer, press Characterizer Options. Go to page 6-14. To review/modify journal limit setups, press Journal Limit. Go to page 6-15. To review/modify journal interval settings, press Journal Interval. Go to page 6-18. To review/modify threshold settings for EN50160 monitoring, press EN50160 Options. Go to page 6-20. Press Next to accept threshold settings for advanced setups and to display memory card screen. Go to page 5-20. Press Prev to return to the Monitoring Mode screen. Go to page 5-18. Press Cancel to quit and return to Start Menu. 	<p>The following screen will appear if the selected monitoring mode is non-EN50160:</p>  <p style="text-align: right;">MARK112</p> <p>The following screen will appear if the selected monitoring mode is EN50160 Power Quality:</p>  <p style="text-align: right;">MARK112b</p>

Transient Limit

Transient detection	<p>Dranetz-BMI instruments label rms voltage or current variations as either sags (voltage or current decreases below low limit) or swells (voltage or current increases above high limit) as per IEEE 1159. Voltage disturbances which are shorter in duration than typical sags and swells are classified as transients. Two basic types of transients are: 1) impulsive transients characterized by very rapid changes in the magnitude of measured quantities and commonly caused by capacitors or inductors switching on line, loose wires, lightning, static, and power failures; and 2) oscillatory transients defined as a temporary, rapid discontinuity of the waveform. The PowerVisa has extensive recording capabilities for low and medium frequency transients using the following trigger mechanisms:</p> <ul style="list-style-type: none"> • RMS difference cycle-to-cycle • Crest or Absolute peak (Instantaneous) • Waveshape cycle-to-cycle magnitude/duration variation
RMS variations	<p>RMS stands for root mean square, a mathematical formula used to measure the average voltage and current behaviors. RMS variations result whenever voltage or current behaviors rise above or fall below the programmed thresholds. See RMS Variation Limit on page 6-8 for more information on rms variations.</p>
Absolute peak settings	<p>The crest factor or instantaneous peak is the absolute peak sample value within one cycle. The instantaneous peak triggers on the absolute peak value of the entire waveform.</p>
Waveform capture settings	<p>Oscillatory transients are types of disturbances usually captured as waveshape faults. The PowerVisa captures pre-trigger and post-trigger waveform cycles. The waveshape fault triggering algorithm essentially compares the samples for each cycle to the corresponding samples from the previous cycle. If the samples differ by more than the threshold tolerance for a length of time exceeding window percent of the power frequency cycle, a waveshape fault is registered. A trigger occurs when either waveshape or rms deviation rise above the programmed thresholds. Waveshape trigger values include the magnitude and duration of the difference between the present and previous cycle.</p> <p>Once a record trigger is detected, instantaneous waveform information is recorded for the prescribed voltage and current channel(s). Disturbance monitoring requires that voltage be continuously sampled, and recorded only if the signals exceed specified values. Waveshape changes are only triggerable for voltage transients as the current waveshapes are usually continually changing on a normally operating distribution system. However most types of disturbances require that current be recorded as well to help determine the source of the disturbance.</p>

Procedure to record transient disturbance

PowerVisa uses three different algorithms to detect and record transients:

- Peak or Instantaneous trigger magnitude
- Waveshape threshold duration or window
- Waveshape threshold magnitude or tolerance

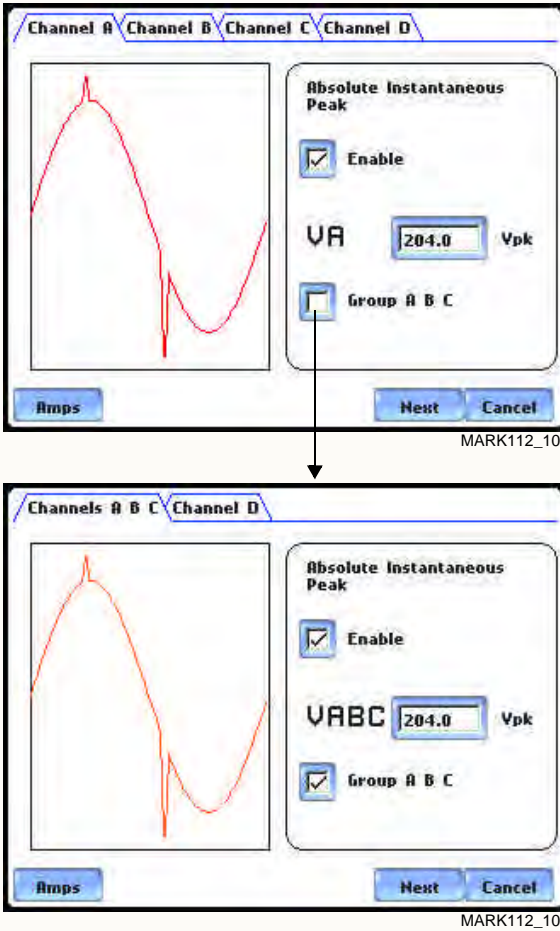
Action...	Result...
<p>STEP 1: From the Advanced Options screen, press Transient Limit.</p> <ul style="list-style-type: none"> • Press the limit field to change limit. Use the keypad to enter the instantaneous limit. This value is compared against the absolute value of each A/D sample of the V and I channel waveforms. <p>NOTE: Do not set this value to less than or equal to the peak of the normal waveform. For a sinusoidal waveform, the peak is 1.414 x the rms value. Failure to do this will result in continuous triggering.</p> <ul style="list-style-type: none"> • Enable toggles whether this limit is enabled or disabled. • Amps toggles between Volts and Amps. • Press Group A B C to set identical limit value for Channels A, B and C. • Press Next to set the waveshape threshold duration. Proceed to Step 2 on page 6-5. • Press Cancel to discard changes and return to Advanced Options menu. 	 <p>The top screenshot shows the 'Absolute Instantaneous Peak' settings for Channel A. The 'Enable' checkbox is checked. The limit value is set to 204.0 Vpk. The 'Group A B C' checkbox is unchecked. A button labeled 'Amps' is at the bottom left, and 'Next' and 'Cancel' buttons are at the bottom right. A watermark 'MARK112_101' is visible.</p> <p>The bottom screenshot shows the same settings but for Channels A, B, and C. The limit value is now 204.0 VABC. The 'Group A B C' checkbox is now checked. A watermark 'MARK112_102' is visible.</p>

Continued on next page

Procedure to record transient disturbance (continued)

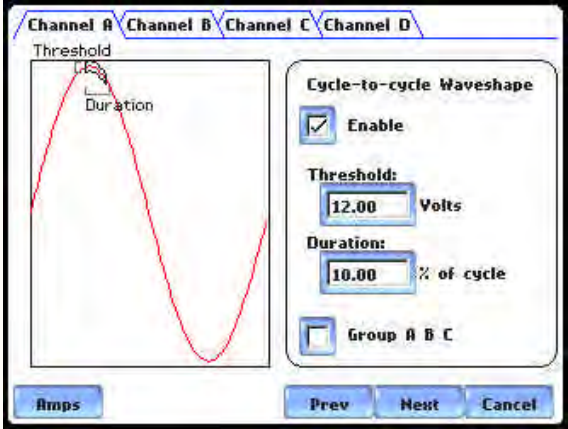
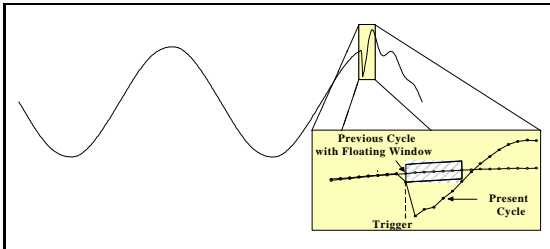
Action...	Result...
<p>STEP 2: PowerVisa shows the “floating window” algorithm used for waveshape fault detection.</p> <ul style="list-style-type: none"> • Press limit field under Threshold to change limit. Use the keypad to enter the threshold limit or tolerance. If the wave samples differ by more than the threshold tolerance for a time exceeding the duration or window percent of power frequency cycle, a waveshape fault is registered. • Press limit field under Duration to change limit. Use the keypad to enter the threshold duration or window. • Enable toggles whether this limit is enabled or disabled. • Amps toggles between Volts and Amps. • Press Group A B C to set identical waveform threshold duration values for Channels A, B and C. • Press Next to set the rms distortion waveshape limit. Proceed to Step 3 on page 6-6. • Press Prev to return to the instantaneous peak transient screen. • Press Cancel to retain previous threshold duration and return to Advanced Options menu. 	 <p>MARK112_104</p> <p>Brief explanation on floating window algorithm:</p>  <p>The figure above helps illustrate the “floating window” algorithm used for waveshape fault detection. This window is visualized on screen as sliding along a waveform, precisely one cycle behind the previous sample point, v_i. The height of the window defines a maximum allowable voltage deviation in magnitude. The width of the duration corresponds to a number of sample points, N. For each sample v_i, when compared to v_{i-1} cycle where the deviation in magnitude is outside the maximum allowable deviation, a counter is incremented. For each sample v_i that is within the maximum allowable deviation, the counter, if greater than 0, is decremented. If the count reaches N, a trigger occurs.</p>

Continued on next page

Procedure to record transient disturbance (continued)

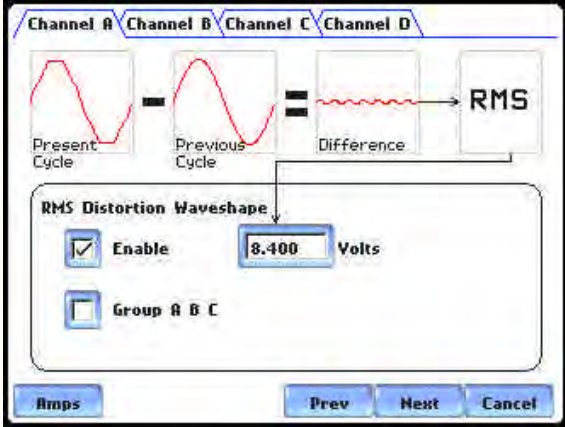
Action...	Result...
<p>STEP 3: PowerVisa allows users to set rms distortion waveshape limit.</p> <ul style="list-style-type: none"> • Press the limit field to change limit. Use the keypad to enter the treshold limit beyond which rms voltage variations occur. • Enable toggles whether this limit is enabled or disabled. • Amps toggles between Volts and Amps. • Press Group A B C to set identical rms threshold value for Channels A, B and C. • Press Next to set the transient waveform capture pre- and post-cycles setup. Proceed to Step 4 on page 6-7. • Press Prev to return to the cycle-to-cycle waveshape screen. • Press Cancel to retain previous rms limit and return to Advanced Options menu. 	 <p style="text-align: right; font-size: small;">MARK112_105</p>

Continued on next page

Procedure to record transient disturbance (continued)

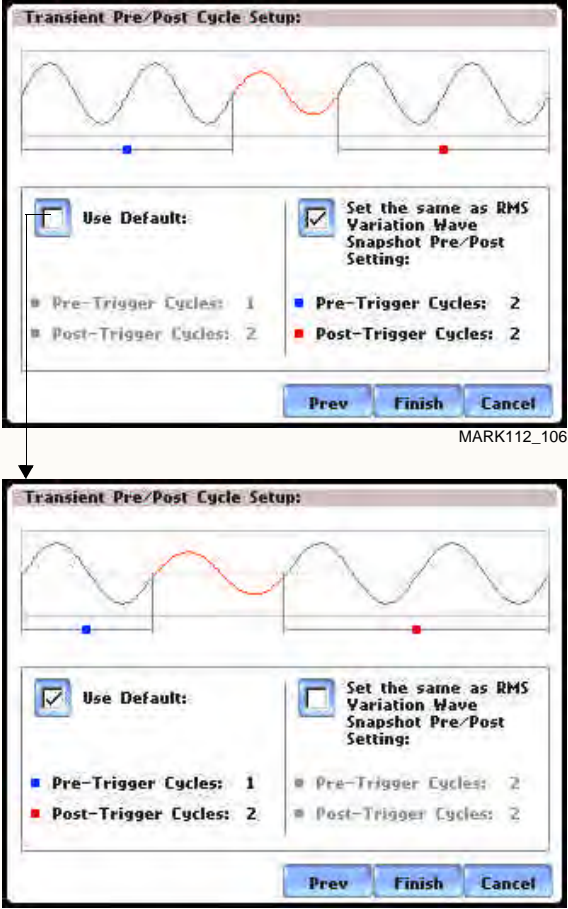
Action...	Result...
<p>STEP 4: Select how you want to specify the number of waveform cycles to record before (Pre-) and after (Post-) the trigger cycle.</p> <ul style="list-style-type: none"> • Enable Use Default if you want to use the default waveform trigger cycle counts for transient events (Pre-trigger cycles = 1, Post-trigger cycles = 2). • Enable Set the same as RMS Variation Wave Snapshot Pre/Post Setting if you want to use the same waveform trigger cycle counts to capture transient events and rms events (Pre-trigger cycles = 2, Post-trigger cycles = 2). See Step 3 of the Procedure to record rms variation on page 6-11. • Press Finish to accept the new waveform capture cycle settings. The screen will return to Advanced Options menu. • Press Prev to return to the rms distortion waveshape screen. • Press Cancel to retain previous cycle counts and return to Advanced Options menu. 	 <p>MARK112_106</p> <p>MARK112_107</p>

Note on phase settings

Phase settings depend upon the wiring configuration or circuit type selected under Setup New Circuit. For example, for wye circuits, Line-Neutral (L-N), Neutral-Ground (N-G), and Line-Line (L-L) voltage limits can be set. For delta circuits, only L-L limits can be set.

RMS Variation Limit

RMS variation setup properties

RMS stands for root mean square, a mathematical formula used to compute the equivalent value of the voltage and current. Voltage and current changes are measured and checked against the programmed limits. Thresholds are set as high limits (threshold above the programmed limit) and low limits (threshold below the programmed limit). RMS variations result whenever voltage or current rms value rise above or fall below the programmed threshold limits. The limits determine how sensitive the instrument should be (note that statistical and trending information is always captured regardless of the limit settings, so the user will never be without a data even if he/she did not set the limits to the ideal values).

The PowerVisa allows users to set the limits for each of the triggers, as well as the amount of rms sample (cycles) to record before and after trigger cycle.

RMS trigger parameters

In order for the instrument to trigger on rms variation, any one of the measured quantities for which a trigger is enabled must go above the High Limit or below the Low Limit for a period of at least one rms sample point (which are taken twice per cycle with a one cycle sliding integration window).

The disturbance end point is defined as the cycle when all channels for which triggers are enabled have come back within limits (plus hysteresis) for a minimum duration of Cycles specified in range to end event. Until this criteria is met, any subsequent excursions beyond the thresholds are considered part of the original disturbance. To minimize the number of triggers recorded for a sequence of closely spaced disturbances, hysteresis is employed in both voltage and time for the begin-event and end-event thresholds.

NOTE: Hysteresis values assigned to limits are set by the system and not programmable by the user.

Procedure to record rms variation

The following parameters are required to define how an rms variation is triggered:

- Low Limit
- High Limit
- Cycles in range to end event

Action...	Result...
<p>STEP 1: From the Advanced Options screen, press RMS Variation Limit.</p> <ul style="list-style-type: none"> • Press the threshold parameter (High, Low, Very Low) to change/enable or disable threshold values. See Appendix G Event Classification for definition of limit values. Proceed to Step 2 on page 6-10. • Press % of Nominal to display the base unit for entering thresholds. To enter limits in percent of nominal, check the % of nominal checkbox. If unchecked, limits are entered in absolute values. • Press Group A B C to set identical threshold values for Channels A, B and C. • Press Next to define the number of rms summary and rms waveform cycles to be saved. Proceed to Step 3 on page 6-11. • Press Cancel to discard changes and return to Advanced Options menu. 	<p>MARK112_201</p> <p>MARK112_202</p> <p>MARK112_206</p>

Continued on next page

Procedure to record rms variation (continued)

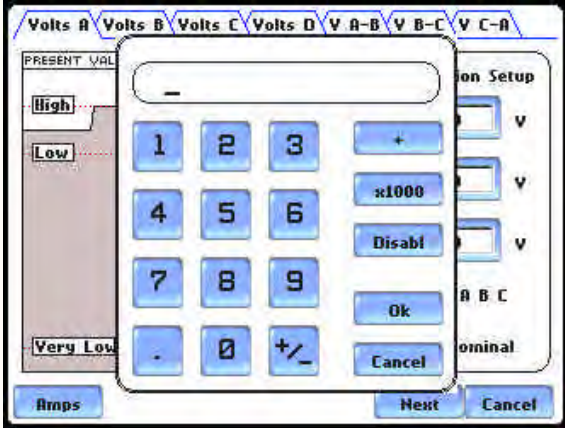
Action...	Result...
<p>STEP 2: Press the High limit, Low Limit, and/or Very Low Limit field to display the numeric keypad used to set threshold values. Use the keypad to enter limits for the corresponding phase in the High limit, Low Limit, and Very Low Limit fields. RMS variation event occurs at the time one or more phases of voltage or current goes outside of the programmed limits. The event ends when all channels for which triggers are enabled have come back within the limits for the duration of the cycles specified to end event.</p> <ul style="list-style-type: none"> • Press Disabl to deactivate the limit field. • Press OK to accept the new threshold limits for rms variation. • Press Cancel to discard changes and return to the rms Variations Setup screen. • When done entering limit values, close the keypad (press OK or Cancel). 	 <p>NOTE 1: Parameter thresholds are best left disabled unless you have an application that specifically calls for them.</p> <p>NOTE 2: The High limit must be set at least .1 higher than the Low limit for each active channel or the entered value will not be accepted.</p> <p>NOTE 3: Hysteresis values assigned to limits are set by the system and not programmable by the user.</p>

Continued on next page

Procedure to record rms variation (continued)

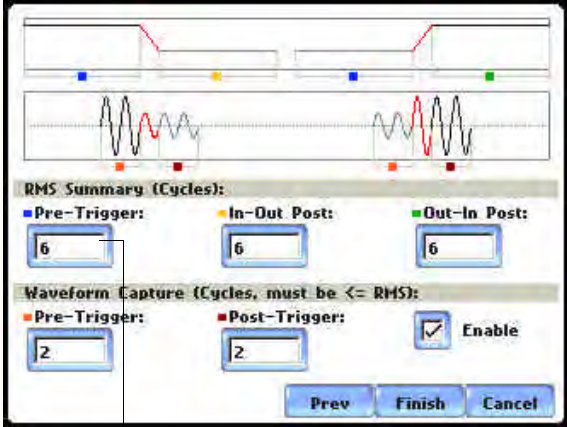
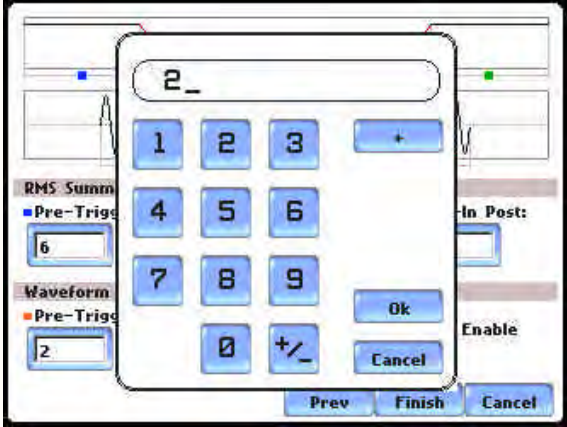
Action...	Result...
<p>STEP 3: Users can define the number of rms summary and waveform cycles to be saved before the start (pre-), after the start (post-start), and after the end (post-end) of the event.</p> <p>The Pre- and Post- trigger settings under Waveform Capture (Cycles) specify the number of waveform cycles to record before, during, and after the event. Although waveform cycle recording is enabled by default, users have the option not to record waveform cycles.</p> <ul style="list-style-type: none"> Press Enable to turn waveform cycle recording on/off. <p>Press any Pre- or Post- trigger cycle field. Use the numeric keypad to enter the cycle counts for corresponding rms sample/waveform cycle capture.</p> <p><u>RMS Summary (Cycles):</u></p> <ul style="list-style-type: none"> Press Pre-Trigger to set the number of cycles for Pre-event start rms samples. This setting is also used for Pre-event end cycles. Use the keypad to enter the number of cycles of rms samples to record before the event start trigger cycle. Press In-Out Post to set the number of cycles for Post-event start cycles. Use the keypad to enter the number of cycles to record after the event start cycle. The maximum number of cycles to record is 100 cycles. Press Out-In Post to set the number of cycles for Post-event end cycles. Use the keypad to enter the number of cycles to record after the event end point. The maximum number of cycles to record is 100 cycles. 	 <p>MARK112_209</p>  <p>MARK112_212</p>

Continued on next page

Procedure to record rms variation (continued)

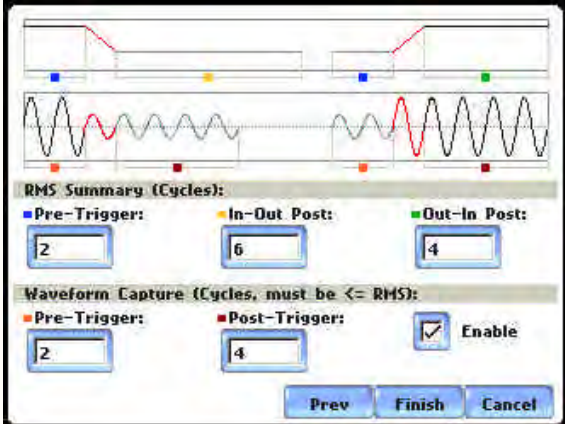
Action...	Result...
<p>STEP 3 (continued):</p> <p><u>Waveform Capture (Cycles):</u> These values can also be used for transient waveform capture.</p> <ul style="list-style-type: none"> • Press Pre-Trigger to set the number of cycles for Pre-event start waveform cycles. Use the keypad to enter the number of waveform cycles to be saved before the event start and event end cycles. • Press Post-Trigger to set the number of cycles for Post-event end waveform cycles. Use the keypad to enter the number of waveform cycles to be saved after the event start and event end cycles. <p>When done entering values, close the keypad by pressing OK to accept the new cycle count settings or Cancel to ignore changes and return to previous cycle settings.</p> <ul style="list-style-type: none"> • Press Finish to accept the new cycle count settings for rms variation. • Press Prev to return to the RMS Variation Limit screen. • Press Cancel to retain previous cycle count settings and return to Advanced Options menu. 	<p>Screen below shows sample changes in cycle settings:</p>  <p>MARK112_213</p>

NOTE

The number of pre-trigger cycles for waveform capture should be less than or equal to the number of pre-trigger cycles for rms summary. The same applies to the post-trigger cycles.

Waveform Capture

Trigger channel setup The PowerVisa allows users to set the trigger channels/parameters for waveform capture.

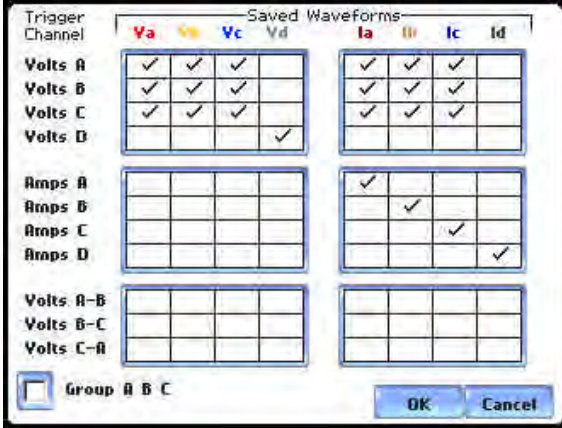
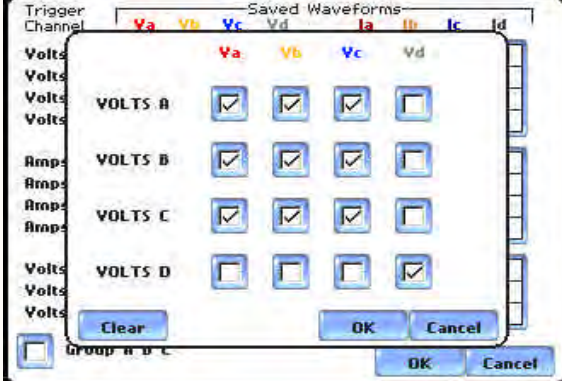
Action...	Result...
<p>STEP 1: The checked fields show the channels that will have waveforms recorded should a trigger occur. This cross-trigger function prevents recording of meaningless data from unused (disabled) channels.</p> <ul style="list-style-type: none"> Press to select the Volts or Amps channel matrix. The channels selected for the matrix will be displayed. Each matrix assigns a different group to trigger and save. See NOTE describing the characteristics of each channel matrix. <p>Check/Uncheck a channel field to enable/disable channel for waveform capture. Proceed to Step 2.</p> <ul style="list-style-type: none"> Press OK to accept new trigger channel settings and return to Advanced Options menu. Press Cancel to retain previous trigger channel settings and return to Advanced Options menu. Press Group A B C to set identical matrix for Channels A, B and C. 	 <p>NOTE:</p> <p>First row channel selection: When individual Volts (V_A, V_B, V_C, V_D) trigger, save waveform data for the checked channels under “Saved WaveForms”.</p> <p>Second row channel selection: When Amps (I_A, I_B, I_C, I_D) trigger, save waveform data for the checked channel under “Saved WaveForms”.</p> <p>Third row channel selection: When Volts phase-to-phase settings (V_{A-B}, V_{B-C}, V_{C-A}) trigger, save waveform data for the checked channels under “Saved WaveForms”.</p>
<p>STEP 2: Depending on the matrix selected, press to check/uncheck the trigger channel for waveform capture.</p> <ul style="list-style-type: none"> Press Clear to reset channel matrix. The previous channel settings will be cleared. 	

Characterizer Options

Event characterizer setup

Events will be characterized according to the measurement standard selected under the characterizer mode.

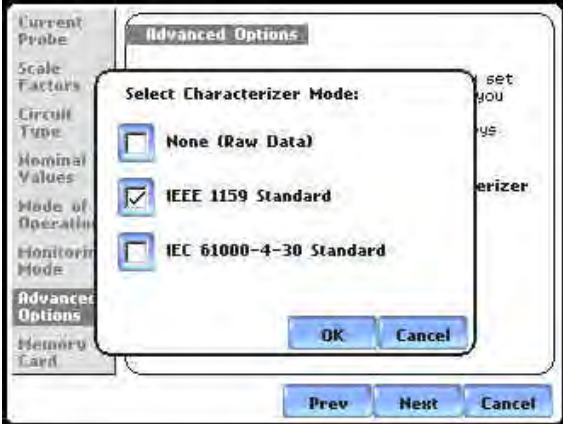
Action...	Result...
<p>STEP 1: From the Advanced Options screen, press Characterizer Options.</p> <p>The PowerVisa measures event data in compliance with the criteria set by IEEE 1159 or IEC 61000-4-30 Class A.</p> <ul style="list-style-type: none"> • Check to select IEEE 1159 Standard or IEC 61000-4-30 Standard to characterize event data. Check None (Raw Data) if you do not want to characterize event data according to any measurement standard. • Press OK to accept changes in characterizer setting and return to Advanced Options menu. • Press Cancel to retain previous characterizer setting and return to Advanced Options menu. 	 <p>MARK112_214</p>

Refer to Appendix F Event Classification for information on the range of variations as per IEEE and IEC Standards.

Journal Limit

Journal entry settings

PowerVisa allows power parameters to be trended using periodic readings that are stored in a journal. Statistical information is always captured regardless of the limit settings, so users will never be without a trend even if he/she did not set the limits correctly. The system collects data even when no disturbances occur by recording periodical statistical data (By Time).

Page 6-16 shows one example of how to set entries under the Standard - Basic parameter. The same procedure applies when setting entries under other journal parameters.

Page 6-17 features the list of journal parameters that can be trended.

Logging data by limits

Limit methods allow users to set the threshold units by which high and low limits of voltage trigger and current trigger are calculated. Thresholds are set in ranges with high limit (threshold above the normal range) and low limit (threshold below the normal range). The following threshold limits are used to trend journal parameters:

Very High: specifies an absolute limit for comparison that is higher than the high limit

High: specifies an absolute limit for comparison that is higher than the low limit

Low: specifies an absolute limit for comparison that is lower than the high limit

Very Low: specifies an absolute limit for comparison that is lower than the low limit

Deadband: specifies how much a value can change before another event is recorded

The Very high must be greater than High, Very low less than Low. Deadbands or sensitivity is used to record incremental changes in the parameter besides when limits are crossed. The hysteresis values assigned to limits are fixed and not programmable by the user. All limit values are used to determine if corresponding reporting or logging action should take place.

Logging data by time

PowerVisa is able to measure periodic samples as well as take snapshots of the voltage and/or current waveform. The Journal Interval menu (see page 6-19) allows users to set the time of how often the instrument will record power parameter values, demand and energy, harmonics, and flicker.

NOTE

Users can record data simultaneously by limits and by time. Make sure to enable the parameters to trend under Journal Categories and Journal Interval.

Sample journal parameter setup

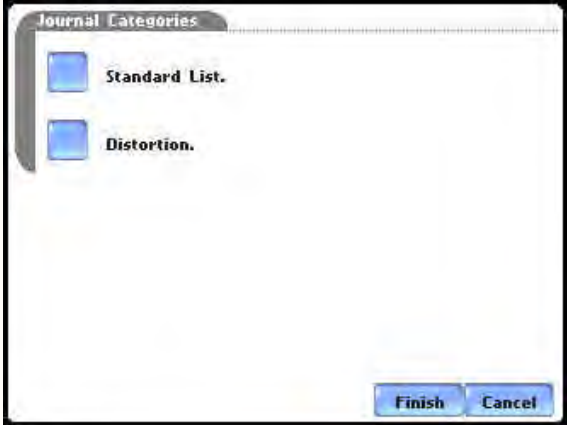
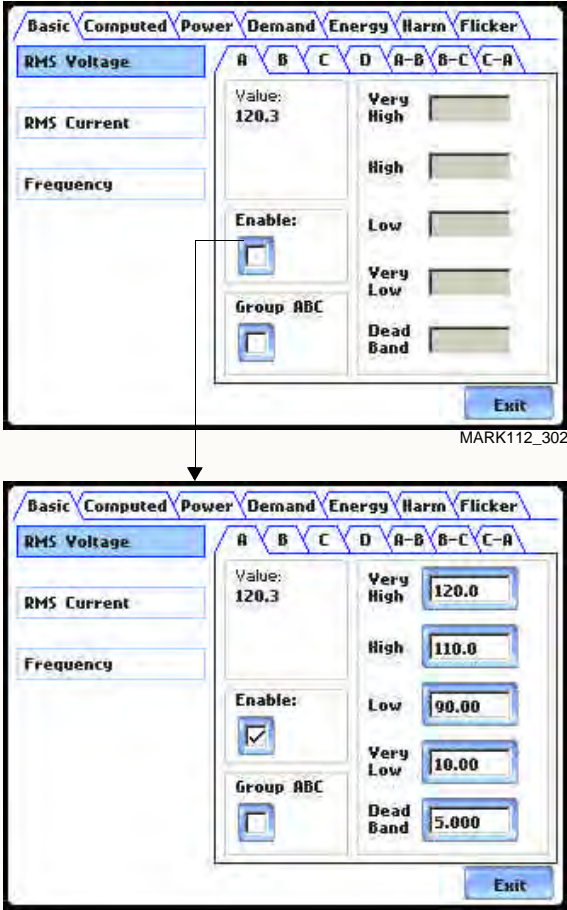
Action...	Result...
<p>STEP 1: From the Advanced Options screen, press Journal Limit. The Journal Categories screen will be displayed.</p> <p>Press a category to display journal parameters and the limit setup menu. For example, press Standard List to display the parameters under it. Proceed to Step 2.</p>	 <p>MARK112_301</p>
<p>STEP 2: Press to select the journal parameter you want to set up.</p> <ul style="list-style-type: none"> • Press to select the applicable phase (A, B, C, D) or phase-to-phase setting (A-B, B-C, C-A) where you want to set threshold limits. • If you want to set threshold limits to capture data, press to check Enable. The limit fields will be activated to allow you to enter threshold values. <p>Press the limit field (Very High, High, Low, Very Low, Dead Band) to display the numeric keypad. Use the keypad to enter the limits for the corresponding phase.</p> <ul style="list-style-type: none"> • Press Exit to accept the new threshold limits for the journal entry. • If you want to record periodical statistical data by time interval, select Journal Interval under Advanced Options screen. Refer to pages 6-18 to 6-19. 	 <p>MARK112_302</p> <p>MARK112_302b</p>

NOTE

Repeat the same procedure to set entries for other journal parameters.

**Journal
Parameter List**

The following parameters are available for trending under the Journal Limit Setup. Refer to Appendix B Technical Specifications - Computed Parameters for the definition of parameters.

Standard List						
Basic	Computed Basic	Power	Demand	Energy	Harmonics	Flicker
RMS Voltage	Vector Displacement PF	Active Power	Active Power Demand	Watt Hrs	Voltage THD	Short Term Flicker
RMS Current	Arithmetic Displacement PF	Apparent Power	Apparent Power Demand	VA Hrs	Current THD	Slide Long Term Flicker
Frequency	Residual Current	Reactive Power	Reactive Power Demand	VAR Hrs	Harmonic Power Unsigned	Long Term Flicker
	Net Current	True Power Factor	RMS Current Demand			
		Displacement Power Factor				

Distortion					
Total Harmonic Distortion	Total Interharmonic Distortion	Telephone Influence Factor	Crest Factor	Power	Transformer
Voltage THD (Fund)	Voltage TID (Fund)	Voltage TIF (Fund)	Volts Crest Factor	Harmonic Power Signed	Transformer Derating Factor
Current THD (Fund)	Current TID (Fund)	Current TIF (Fund)	Amps Crest Factor	Harmonic Power Unsigned	Transformer K Factor
Voltage THD (RSS)	Voltage TID - (RSS)	Voltage TIF (RMS)			
Current THD (RSS)	Current TID - (RSS)	Current TIF (RMS)			
		TIF Current Product			

Journal Interval for Timed Readings

Introduction

The Journal Interval screen allows users to define how often the PowerVisa saves data periodically, regardless of power quality disturbances and journal limits.

Definitions

Power Values

Power Values Interval - Power parameter values are based upon all cycles during a one second interval. Data is aggregated or summarized into min, max and avg values over the averaging period and stored at the end of the interval. Data measured include watts, power factors, as well as the one-second rms (not to be confused with the one cycle rms). Cyclic min, max and avg are based upon full cycle waveforms with a resolution of one half (1/2) cycle. They record the rms, crest, and waveshape parameters that are also used to capture a snapshot of the waveform. Note that if users did not set the thresholds for rms variations properly, the min, max and avg will still provide a record of what happened during the interval.

Waveform Snapshot- Contains properties that measure periodic sample or snapshot of the voltage and/or current waveform. Users are able to determine how often the instrument will record waveform snapshots by turning the function on or off.

Demand and Energy

Demand Sub-Interval and *Sub-Intervals per Interval* - Refer to the time interval used in calculating power demand values. Demand calculations are made every sub-interval on the values that occurred during the most recent Demand Interval. Values set for Demand Sub-Interval must be an integer-divisor of the Demand Interval since the former applies when updating certain parameters of the latter.

Harmonics

Harmonics Journal Interval - Various harmonic parameters such as total harmonic distortion (THD), total interharmonic distortion (TID), and telephone influence factor (TIF) can be trended using periodic readings that are stored in the journal. Depending on the harmonic journal interval set, the instrument records a sampling of the waveform synchronized to the fundamental frequency, to ensure accurate calculation of harmonic phase angles.

Flicker

Pst (Short Term) Interval - Pst is short term perceptibility, used to set the Pst calculation interval. Typical calculation is over a 10-minute interval, though users can specify Pst Interval under Flicker.

Plt (Long Term) Interval - Plt is long term perceptibility, used to set the Plt calculation interval. Typical calculation is over a 2-hour interval, though users can specify Plt Interval under Flicker.

The Plt interval must be an integer multiple of the Pst interval. Sliding Plt recalculates the Plt value at each Pst interval, rather than only at the Plt interval.

Timed settings menu

The intervals for timed readings are user programmable.

Action...	Result...
<p>STEP 1: From the Advanced Options screen, press Journal Interval. The Journal Interval menu will be displayed.</p> <p>Press the parameter that you want to change. Each journal interval must be pressed repeatedly to display the available selection values.</p> <ul style="list-style-type: none"> • Selections for Power Values: <u>Power Values Interval</u>: OFF, 1 SEC, 1 MIN, 2 MINS, 3 MINS, 5 MINS, 10 MINS, 15 MINS, 1 HR <u>Waveform Snapshot</u>: OFF, ON • Selections for Demand and Energy: <u>Demand Sub-Interval</u> (in MINUTES): OFF, 3, 5, 10, 15 <u>Sub-Intervals per Interval</u>: OFF, 1, 2, 3, 4, 5, 6 • Selections for Harmonics: <u>Harmonics Journal Interval</u>: OFF, 30 SEC, 1 MIN, 2 MINS, 3 MINS, 5 MINS, 10 MINS, 15 MINS, 1 HR • Selections for Flicker: <u>Pst (Short Term) Interval</u> (in MINUTES): OFF, 1, 2, 3, 5, 10, 15, 30 <u>Plt (Long Term) Interval</u> (in HOURS): OFF, 1, 2, 3, 4, 8 • Press Finish to accept the new timed settings. • Press Cancel to retain previous timed settings and return to Advanced Options menu. 	 <p>MARK112_401</p>

EN50160 Power Quality (for strict EN50160 monitoring only)

Advanced setup options for EN50160

EN50160 is a statistical analysis of power quality data based on the EN standard. The statistical package called Quality of Supply (QOS) is built into the PowerVisa, with monitoring and setup protocols set to determine voltage measurement compliance required for EN50160 monitoring. The EN50160-required measurement parameters include Power Frequency, Supply Voltage Variations, Rapid Voltage Changes, Supply Voltage Unbalance, Harmonic Voltage, Interharmonic Voltage, and Mains Signalling. The monitoring site is said to be IN COMPLIANCE if the statistical value over one (1) week for the specified parameters is 95% or greater.

EN50160 Options setup allows users to define up to five mains signalling frequencies below 3 KHz. Users can also select pre-defined values for main voltage characteristics of electricity supplied by Low Voltage (LV) and Medium Voltage (MV) public networks.

NOTE

EN50160 is defined for the electricity supplied at the supply terminals, and does not deal with the supply system or consumer's installation or electrical equipment itself. Since the standard deals with the voltage characteristics which can be expected in public distribution networks, other aspects essential for supply quality (i.e. short circuit power) are not treated within the scope of the standard. EN50160 standard is applicable only under normal operating conditions of the supply system.

EN50160 optional settings

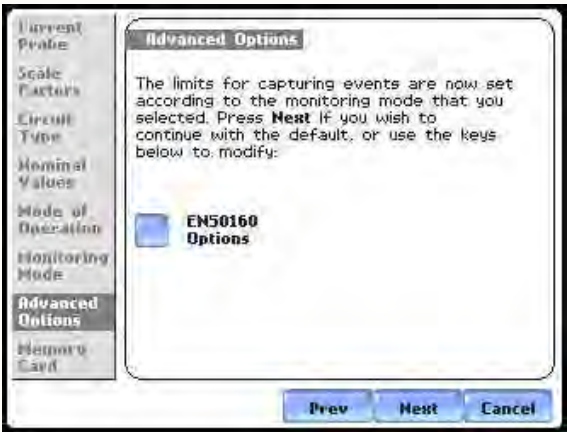
Action...	Result...
<p>STEP 1: From the Choose Monitoring Mode screen, select EN50160 Power Quality, then press Next to display Advanced Options for EN50160.</p> <ul style="list-style-type: none"> • If the default settings for the EN50160 PQ monitoring are acceptable without change, press Next. The Site Name/ Memory Card screen will appear. See pages 5-20 to 5-23. • To review and/or modify threshold settings for EN50160 monitoring, press EN50160 Options. Proceed to Step 2 on page 6-21. • Press Cancel to quit and return to Start menu. 	 <p style="text-align: right; font-size: small;">MARK112B</p>

Continued on next page

EN50160 optional settings (continued)

Action...

STEP 2: EN50160 Options allow you to define up to five frequency signals set in 5 Hz resolution.

Mains signalling compliance or non-compliance is determined by calculating/adding the status of each of the defined frequencies.

- To modify frequency settings for EN50160 monitoring, press the desired frequency field. Use the numeric keypad to enter new frequency values.
- Press to select from the following EN50160 monitoring voltage levels: **Leave as is (120 Vrms)**; **Low Voltage (230 Vrms, +/-10%)**; **Low Voltage (230 Vrms, +10/-6%)**; **Low Voltage (230 Vrms, +6/-10%)**; **Medium Voltage (11 kVrms)**. LV is defined as <1kV nominal. MV is 1kV to 35kV nominal.
- Press to enable/disable miscellaneous option **Islanded**. Islanded means isolated from the power grid. Islanded is disabled by default, indicating that the system being monitored is synchronized to grid.
- Press **Next** to accept changes in EN50160 setup and return to the EN50160 Advanced Options screen.
- Press **Cancel** to discard changes in EN50160 setup and return to the EN50160 Advanced Options screen.

Result...

MARK112c

MARK112c

Refer to Chapter 8 Reports for a detailed discussion of the EN50160 compliance bar charts and statistical reports.



CHAPTER 7



View Event Data

Overview

Types of data display

PowerVisa offers a graphical, information-packed, and easy to navigate display of event data. The firmware architecture of the PowerVisa is designed to engage in various stages of acquisition, characterization, communication, and visualization of event data and journalled data. It also does Quality of Supply or QOS compliance monitoring as specified by EN50160, which requires that measurement parameters must be within a specified percentage for 95% of the time.

Event: An event occurs when a programmed threshold is crossed. An event consists of pre-trigger cycle(s), trigger cycle (fault), and post-trigger cycle(s). A contiguous collection of cycles caused by events is recorded into memory. An event may also contain information about other channels depending on how the user sets up the application.

Trend: A trend is a graph of the value of one parameter and channel over time. Trends aim to show a macro view interface of timespan, trigger conditions, and channels of waveforms and rms that were recorded. Users can zoom in on trends for a more detailed view.

View data icons

The Events and Trend icons are used to view event data. Both icons are accessible at the Home page.

The Events button will display event activity graphs, waveform display, event Detail magnification, and Options to change and/or add parameters/channels to plot. Buttons to view previous/next event and waveform/rms cycle display are also available.

NOTE: Event data becomes available while the instrument is monitoring or by loading a previously saved file from the data card. Otherwise, a status message appears indicating that there are no event data available to view.

The Trend button displays time plots or trend visualizations of journalled data. The parameters to plot consist of journal entries under the Journal Limit Setup (see pages 6-18 to 6-20). The Trend screen can display up to four plots, with a maximum of two parameters per plot. One parameter can have multiple channels to plot. Users have the option to enable/disable plot display, where display area will resize according to the number of plots enabled for display. The Trend screen also features a Zoom box, where users can expand or narrow the zoomed area via touch and drag. Users can select the trend coordinates to view in detail.

**Downloading
and viewing
data on a
computer**

Event files stored in data card can also be viewed on the computer. Insert the card to a Compact Flash card reader connected to the computer. No communication software protocol between the PowerVisa and computer is necessary.

Dranetz-BMI NodeLink® and DranView® programs are required to retrieve event data in the computer. NodeLink® transfers stored data from the PowerVisa to a computer via standard RS-232 serial port, USB port, Ethernet, or modem connection. DranView® is a viewer and data analysis software that allows users to manage event data downloaded in the computer. See Chapter 9 - Downloading Events for more information on NodeLink® and DranView® applications.

NodeLink® and DranView® are owned and distributed by Dranetz-BMI. For pricing and availability, contact Dranetz-BMI Customer Service Department at (732) 287-3680 or 1-800-372-6832.

View data using Events, Trend

Follow these steps to display event data.

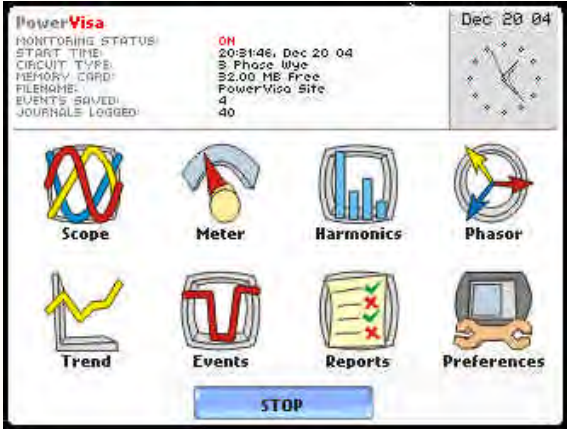
Action...	Result...
<p>STEP 1: Events and Trend are accessible from the Home screen. Note that event data will be available for display while monitoring or upon reading a stored file from the data card.</p> <p>A monitoring status message appears on the top section of the screen. Refer to Chapter 5 Start Menu - Section C Monitor Same Circuit on page 5-24 for the procedure on how to capture events by turning monitoring on.</p> <ul style="list-style-type: none"> • Press Events to view event list, graphs and waveform/rms display. Proceed to Section A - Events on page 7-4. • Press Trend to trend journal data and view time plots. Proceed to Section B - Trend on page 7-17. 	 <p>The screenshot shows the PowerVisa interface. At the top left, it displays 'PowerVisa' and monitoring status: 'ON', '20:31:46, Dec 20 04'. Below this, it lists 'CIRCUIT TYPE: 3 Phase Wye', 'MEMORY CARD: 32.00 MB Free', 'FILENAME: PowerVisa Site', 'EVENTS SAVED: 4', and 'JOURNALS LOGGED: 40'. A clock icon shows 'Dec 20 04'. The main area contains eight icons: 'Scope' (waveform), 'Meter' (gauge), 'Harmonics' (bar chart), 'Phasor' (3D vector), 'Trend' (line graph), 'Events' (waveform with red markers), 'Reports' (document with checkmarks), and 'Preferences' (hand with wrench). A 'STOP' button is at the bottom.</p> <p style="text-align: right;">PVISA002</p>

In this chapter This chapter covers the following topics.

Section	Topics	See Page
A	Events	7-4
B	Trend	7-17

Section A

Events

Overview

What is displayed?

The event screen displays actual voltage or current waveforms that occurred when a certain threshold parameter was crossed. Event activity graphs, event list, waveform display, rms display, and time plots are visually interfaced showing event patterns and behaviors over threshold limits and time. The event screen also enables users to customize data plots, allowing users to change and/or add parameters/channels for each of the four plot areas. Zoom box features, wherein users can expand or narrow the size of a zoomed area via touch and drag, are also available for more thorough data analysis and interpretation. Users can select the number of waveform and rms cycles to view, as well as display event textual summary as shown on pages 7-9 thru 7-13.

In this section

The following topics are covered in this section.

Topic	See Page
Event Data Display	7-5
Event Activity Graph	7-6
Event List	7-7
Event Detail	7-9
Event Options	7-14

Event Data Display

Event screen The event screen will display an event activity graph, waveform detail, and buttons like Detail magnification, Options to change and/or add parameters/channels to trend, buttons to view previous/next event, and RMS/Waveform toggle. From the Home screen, press Events. The following screen will be displayed:

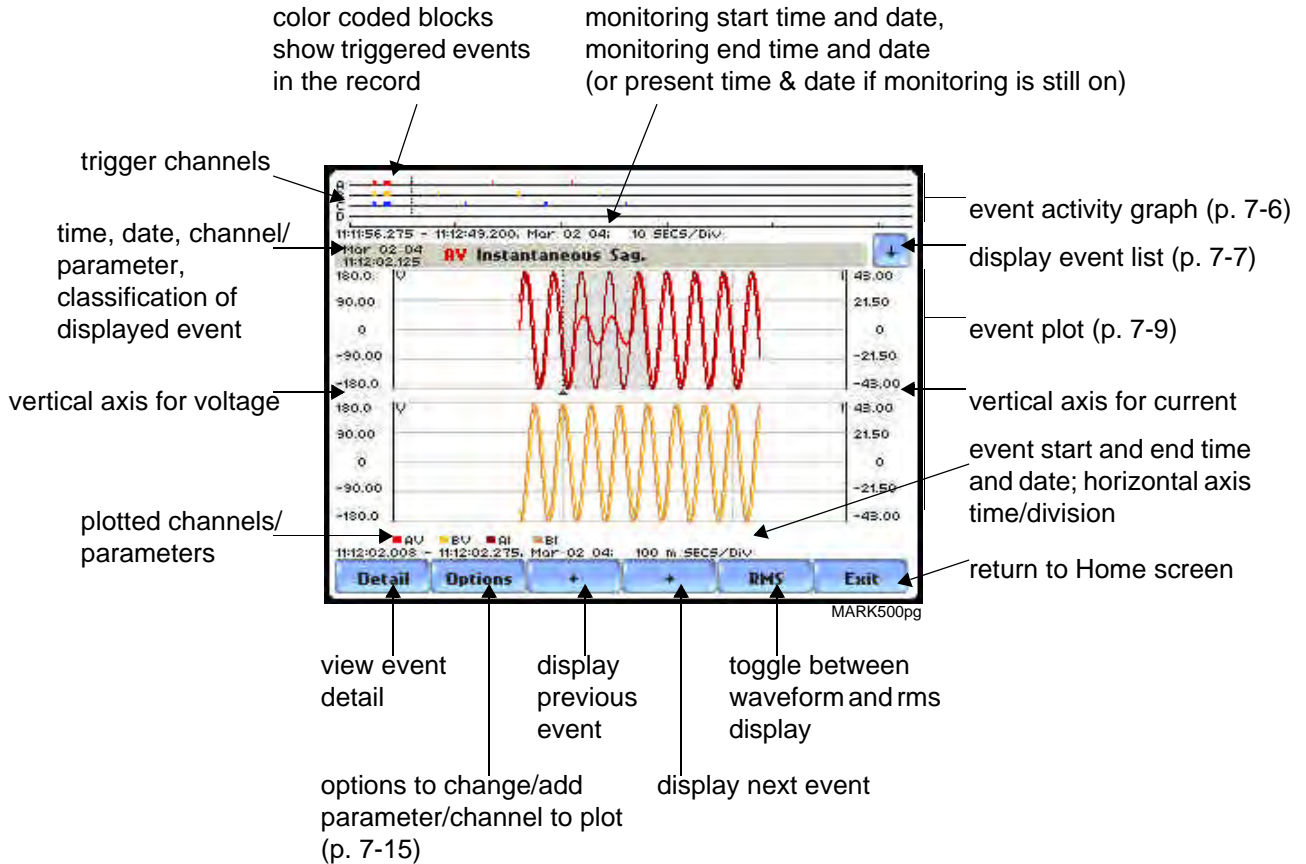

NOTE: Event data is displayed only while monitoring or upon reading a stored file from the data card.

Event Activity Graph

**Event graph
description**

The event graph is located on the top section of the event screen (see page 7-5). Four timelines represent all events recorded from the time monitoring started. Events for voltage channels are displayed above the grid and current channels are displayed below the grid.



Event List

Event list description

Event list presents a summary of all captured events in the order that they occurred. Each event contains a general heading indicating the time and date when the disturbance occurred, the disturbance category, disturbance classification, and number of cycles of duration.

View event list

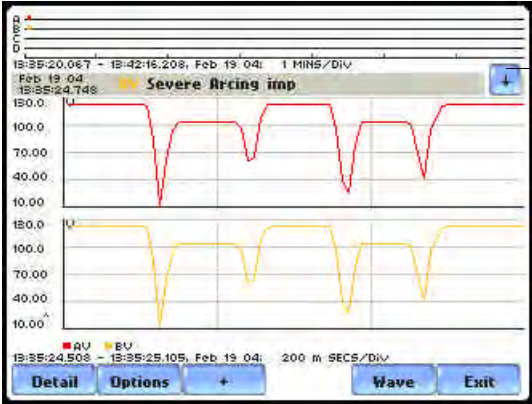
Follow these steps to access the event list. Note that event data becomes available only after monitoring has been turned on or upon reading a file from the data card.

Action...	Result...
<p>STEP 1: From the Home screen, press Events. The down arrow button located on the top right section of the screen is used to access the Event List.</p> <ul style="list-style-type: none"> Press the down arrow button to view the Event List screen. <p>The top section of the Event List screen features a summary description of the selected event (in highlight).</p> <p>Each entry is identified by the time and date when the event was captured, the color coded channel/parameter of captured event, and the event classification.</p> <ul style="list-style-type: none"> Press Up/Down arrow keys to scroll the page up or down by one line or press and drag the scroll bar to move the page up or down. Press to select (highlight) the desired event entry. Proceed to Step 2 on page 7-8. 	 <p>MARK501</p>  <p>MARK502</p>

Continued on next page

View event list (continued)

Follow these steps to access the event list. Note that event data is displayed only while monitoring or upon reading a file from the data card.

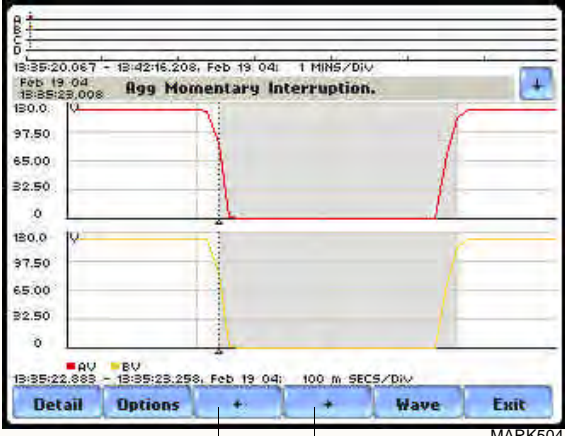
Action...	Result...
<p>STEP 2: The highlighted field indicates that the particular event entry has been selected.</p> <ul style="list-style-type: none"> • Press OK to view details of the selected event. • Press Cancel to ignore event entry selection and return to the default event screen. 	 <p>MARK503</p>  <p>MARK504</p> <p>NOTE: The left and right arrow keys can be used to display previous/next event.</p>

Event Detail

Event details PowerVisa allows users to view events in graphic waveform/rms display. The Detail screen features zoom buttons to magnify event cycles, and a zoom box that users can resize via touch and drag. The Detail screen also allows viewing of events alternately in rms or waveform.

Horizontal axis Auto-scaled to display all waveforms in file until range is narrowed by zoom in.

Vertical axis Auto-scaled to the minimum and maximum value within time range.

View event detail An event detail screen is generated for each event. The detail screen shows events in rms by default. Follow these steps to view event details.

Action...	Result...
<p>STEP 1: From the Home screen, press Events. Events must already be loaded into memory to be available for display.</p> <p>Use the event list to scroll through event entries OR use the left and right arrow keys to view previous/next event display.</p> <ul style="list-style-type: none"> Press Wave/RMS to toggle between waveform and rms display. <p>NOTE: The gray area marks the duration of the event displayed. The dotted black lines indicate the start of event.</p> <ul style="list-style-type: none"> Press Detail to use the zoom features and view waveform/rms in detail. Proceed to Step 2 on page 7-10. 	<p>The top screenshot shows the 'Wave' view for an event titled 'Agg Instantaneous Sag'. It displays three waveforms (AU, BU, CU) with a gray shaded event duration and a dotted vertical line at the start. The bottom screenshot shows the 'RMS' view for the same event, displaying the root mean square values for the three channels. Both screens have a control bar at the bottom with buttons for 'Detail', 'Options', zoom in (+), zoom out (-), 'Wave/RMS', and 'Exit'.</p>

Continued on next page

View event detail (continued)

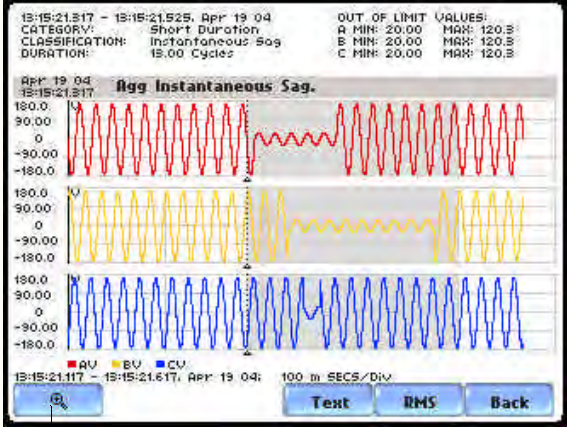
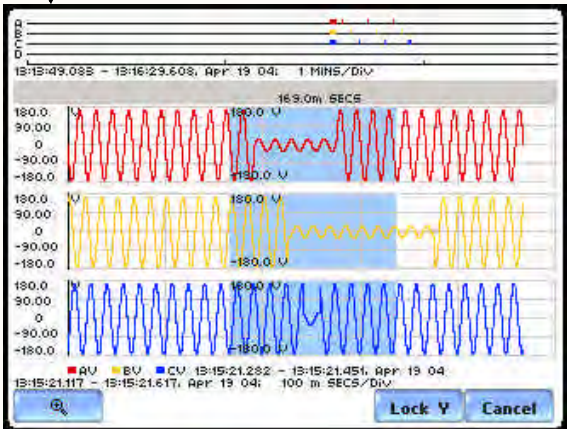
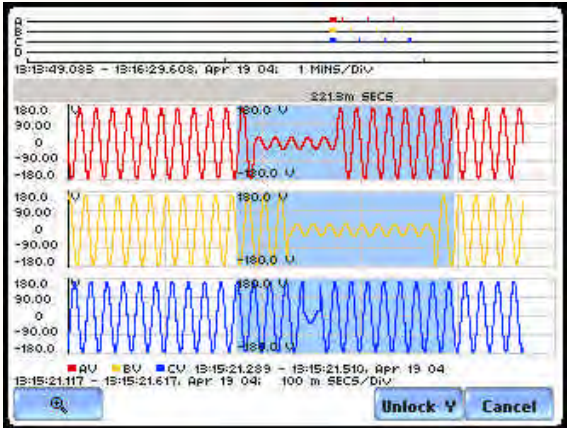
Action...	Result...
<p>STEP 2: Once the magnify button is pressed, a blue box showing the default zoomed area appears. The touch screen zoom functionality allows users to select the number of waveform/rms cycles that they can zoom in.</p> <p>Touch any side of the zoom box to activate the drag function. Touch and drag the sides of the zoom box to expand or narrow in on the waveform/rms cycle. The cycle duration (in seconds) of event covered in the zoom box is also displayed.</p>	 <p>MARK506cpp</p>
<p>NOTE: The horizontal drag is locked between all graphs. This means the horizontal drag will apply consistently to all data plots. The vertical drag is independent by axis. Users have the option to lock/unlock the vertical drag.</p>	 <p>MARK507bpg</p>
<ul style="list-style-type: none"> • Press Lock Y if you want the vertical axis to apply consistently to all data plots. • Press Unlock Y if you want to adjust the vertical axis differently for each data plot. • Once the zoom area is determined, press the Magnify button once. Proceed to Step 3 on page 7-11. 	<p>Resize/move zoomed area by touching and dragging the sides of the zoom box.</p>  <p>MARK508bpg</p>

Continued on next page

View event detail
(continued)

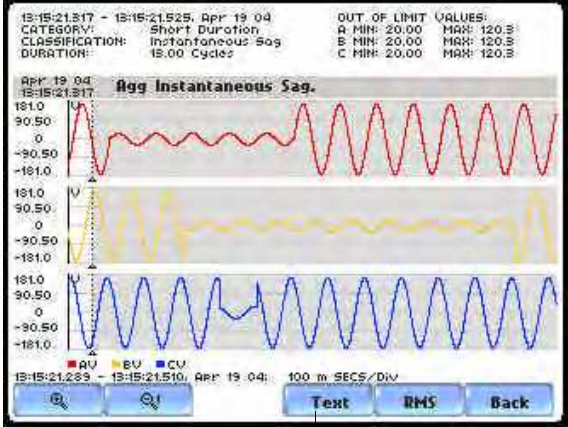
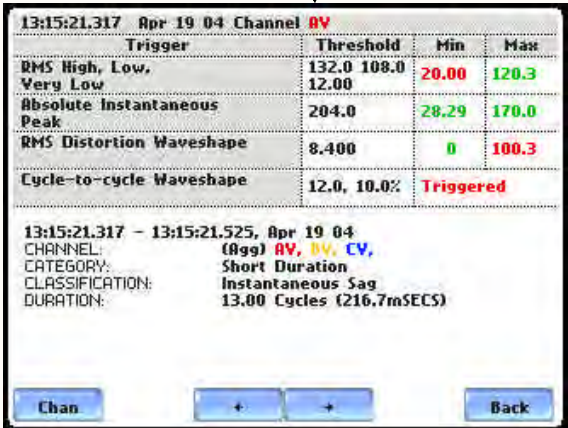
Action...	Result...
<p>STEP 3: The magnify buttons serve as zoom function keys, each of which feature a plus sign or a minus sign within.</p> <ul style="list-style-type: none"> Press Zoom+ to display the zoomed area and view the event cycles in greater detail. Users may repeatedly zoom in on a plot for up to seven (7) levels. To further zoom in on an event cycle, simply repeat the procedure on Step 2. Press Zoom-(n) to unzoom cycles display one increment at a time, where n is the counter of how many times the event cycles have been magnified. Use Wave/RMS to toggle between rms and waveform display. <p>NOTE: Pressing Wave will only display waveform data for channels that are enabled to record waveforms. For channels that do not have associated waveform data, the screen will maintain the format, but will leave the plot blank.</p> <ul style="list-style-type: none"> Use the Text button to display the event threshold values and other details pertaining to the disturbance that occurred. Pages 7-12 and 7-13 show examples of useful event detail included in the textual summary (for select event types only). Press Back to return to the event screen. 	 <p>MARK510bp</p>  <p>MARK519b</p> <p>NOTE: The event textual summary is color coded. Red indicates the threshold value(s) and parameter(s) that are out of limits. Green indicates the measurement parameters that are within limits.</p>

Event text detail: Sag Directivity

PowerVisa is equipped with the algorithm that determines the origin of a 3-phase voltage sag event. The sag origin or directivity can be Upstream or Downstream from the monitoring point. The direction is displayed in the Event Text Detail screen.

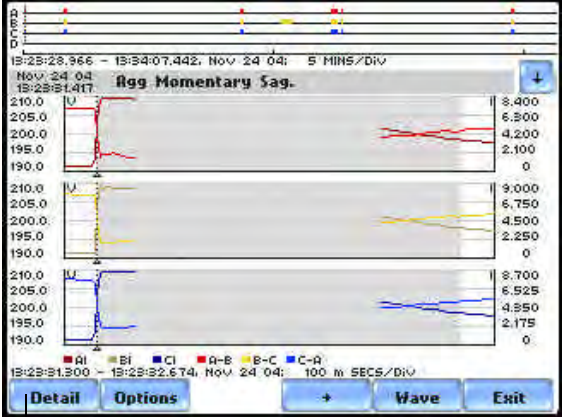
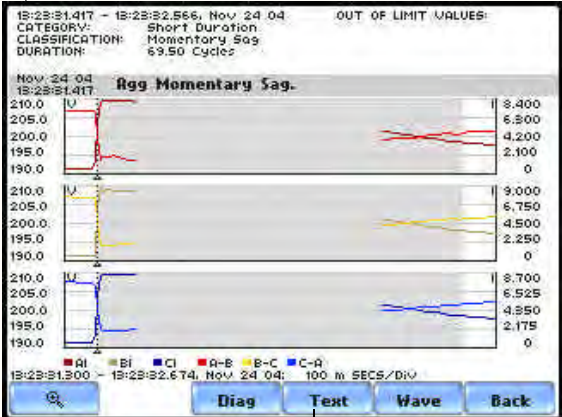
Action...	Result...																												
<p>Once events are available for display, press Detail to display the functions that can be used to further analyze the waveform/rms i.e. the Text button.</p> <p>Press Text to display the event threshold values and textual summary.</p> <ul style="list-style-type: none"> Only events generated by 3-phase voltage and current waveforms will include information on Directivity in the text summary. Directivity shows the origin of the sag whether Upstream or Downstream from the monitoring point if the voltage and current signals are adequate to detect. 	 <p>MARK620</p>  <p>MARK621</p> <table border="1"> <thead> <tr> <th colspan="4">13:23:31.417 Nov 24 04 Channel A-B</th> </tr> <tr> <th>Trigger</th> <th>Threshold</th> <th>Min</th> <th>Max</th> </tr> </thead> <tbody> <tr> <td>RMS High, Low, Very Low</td> <td>228.8 198.0</td> <td>193.8</td> <td>201.0</td> </tr> <tr> <td>Absolute Instantaneous Peak</td> <td>353.6</td> <td>282.9</td> <td>292.3</td> </tr> <tr> <td>RMS Distortion Waveshape</td> <td>14.56</td> <td>594.4m</td> <td>15.93</td> </tr> <tr> <td>Cycle-to-cycle Waveshape</td> <td>20.8, 10.0%</td> <td colspan="2">Not Triggered</td> </tr> <tr> <td>Integrated High Frequency Trigger</td> <td>208.0</td> <td colspan="2">Not Triggered</td> </tr> </tbody> </table> <p>13:23:31.417 - 13:23:32.566, Nov 24 04 CHANNEL: A-B, B-C, C-A CATEGORY: Short Duration CLASSIFICATION: Momentary Sag DURATION: 69.50 Cycles (1.158 SECS) DIRECTIVITY: Downstream</p> <p>MARK622</p>	13:23:31.417 Nov 24 04 Channel A-B				Trigger	Threshold	Min	Max	RMS High, Low, Very Low	228.8 198.0	193.8	201.0	Absolute Instantaneous Peak	353.6	282.9	292.3	RMS Distortion Waveshape	14.56	594.4m	15.93	Cycle-to-cycle Waveshape	20.8, 10.0%	Not Triggered		Integrated High Frequency Trigger	208.0	Not Triggered	
13:23:31.417 Nov 24 04 Channel A-B																													
Trigger	Threshold	Min	Max																										
RMS High, Low, Very Low	228.8 198.0	193.8	201.0																										
Absolute Instantaneous Peak	353.6	282.9	292.3																										
RMS Distortion Waveshape	14.56	594.4m	15.93																										
Cycle-to-cycle Waveshape	20.8, 10.0%	Not Triggered																											
Integrated High Frequency Trigger	208.0	Not Triggered																											

**Event text detail:
Capacitor Switch Analysis**

In addition to determining directivity, PowerVisa is also able to detect if 3-phase voltage and current waveforms experience a capacitor switching event. The result of the analysis is displayed in the Event Text Detail screen.

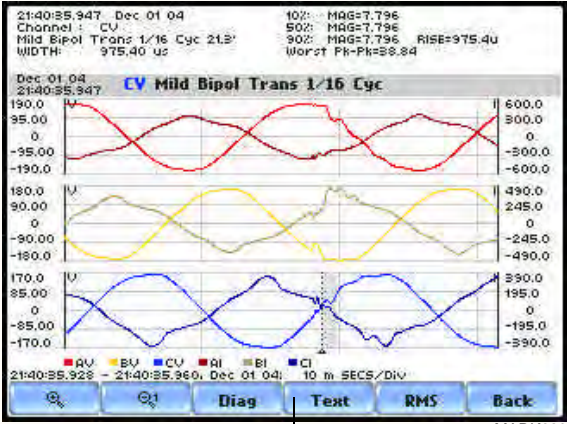
Action...	Result...																								
<p>The following transient event types - bipolar, oscillatory, or capacitor switch - will include text detail on capacitor switch analysis and directivity (when detected). This capacitor switching event is generated only in 3-phase voltage and current waveforms.</p> <p>Press Text to display the event threshold values and textual summary. The text summary will display the following characteristics to describe the capacitor switching event.</p> <ul style="list-style-type: none"> • The type of the event whether it is Normal, Back-to-back, or Re-strike. • The direction of the probable location of the switching capacitor whether it is Upstream or Downstream from the monitoring point. 	 <p>MARK623</p> <table border="1"> <thead> <tr> <th>Trigger</th> <th>Threshold</th> <th>Min</th> <th>Max</th> </tr> </thead> <tbody> <tr> <td>RMS High, Low, Very Low</td> <td>132.0 108.0 12.00</td> <td>119.9</td> <td>119.9</td> </tr> <tr> <td>Absolute Instantaneous Peak</td> <td>204.0</td> <td>164.5</td> <td>164.5</td> </tr> <tr> <td>RMS Distortion Waveshape</td> <td>3.000</td> <td>4.455</td> <td>4.455</td> </tr> <tr> <td>Cycle-to-cycle Waveshape</td> <td>12.0, 10.0%</td> <td colspan="2">Not Triggered</td> </tr> <tr> <td>Integrated High Frequency Trigger</td> <td>120.0</td> <td colspan="2">Not Triggered</td> </tr> </tbody> </table> <p>21:40:35.947 CV Mild Pos Bipol Trans at 21.3°, 1/16 Cyc Worst Peak-Peak = 38.8415 Duration = 975.4u SECS 10% mag = 7.79566 offset 6502.66 u SECS 50% mag = 7.79566 offset 6502.66 u SECS 90% mag = 7.79566 Rise time = 975.40 u SECS Normal/back to back/Restrike Cap Sw, direction is Unknown.</p> <p>Chan + + Back</p> <p>MARK624</p>	Trigger	Threshold	Min	Max	RMS High, Low, Very Low	132.0 108.0 12.00	119.9	119.9	Absolute Instantaneous Peak	204.0	164.5	164.5	RMS Distortion Waveshape	3.000	4.455	4.455	Cycle-to-cycle Waveshape	12.0, 10.0%	Not Triggered		Integrated High Frequency Trigger	120.0	Not Triggered	
Trigger	Threshold	Min	Max																						
RMS High, Low, Very Low	132.0 108.0 12.00	119.9	119.9																						
Absolute Instantaneous Peak	204.0	164.5	164.5																						
RMS Distortion Waveshape	3.000	4.455	4.455																						
Cycle-to-cycle Waveshape	12.0, 10.0%	Not Triggered																							
Integrated High Frequency Trigger	120.0	Not Triggered																							

Event Options

Voltage and Current channels to plot

A time plot is a graph of the value of one parameter and channel over time. The PowerVisa is able to display time plots for individual Voltage and Current channels (Va, Vb, Vc, Vd, Ia, Ib, Ic, Id) or phase-to-phase Voltage channels (Vab, Vbc, Vca), depending on the available channels for Voltage and the selected circuit type.

RMS trigger parameters

RMS variation is the most common type of disturbance and is identified as a specific type of event by IEEE and IEC. Event characterization implemented in PowerVisa adheres to the IEEE 1159 and IEC 61000-4-30 Class A standards (Refer to Appendix F Event Classification). RMS values are updated at half-cycle rates, calculated over one cycle and compared against limits on a cycle-by-cycle basis. The high and low limits can be enabled and programmed individually for each phase and phase-to-phase value.

The following parameters are required to define how an rms variation is triggered:

Very Low limit

Low limit

High Limit

Cycles in range to end event

As per IEEE and IEC standards for multi-phase systems, the beginning of the voltage rms event occurs when any phase voltage goes outside the limits, and ends when all of the phases are within limits for an end-event number of cycles specified. This is only true for voltage, not current.

In addition, rms variations can have three stages of averaging or chart rates, which is particularly useful for long duration events to save memory in exchange for reduced resolution. This mode begins if the rms value remains out of limits for longer than the post-start number of cycles that were programmed.

Refer to Chapter 6 Advanced Setup Options for more information on rms variation limits.

What is displayed on a time plot?

A time plot consists of the timed and threshold waveforms for the parameter on display. The instrument provides users Options to change and/or add parameters/channels to plot.

Channels

Voltage: A, B, C, D, A-B, B-C, C-A

Current: A, B, C, D

View event options

Follow these steps to access event Options.

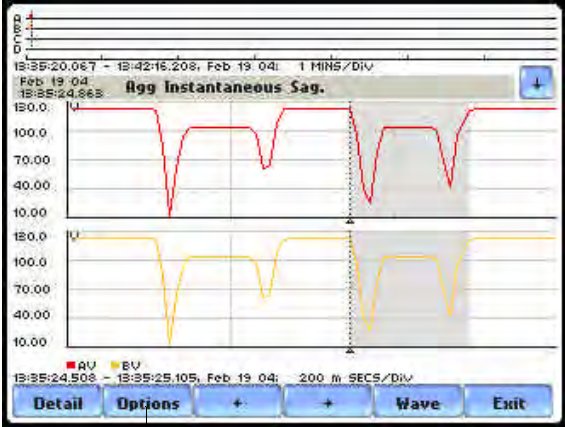
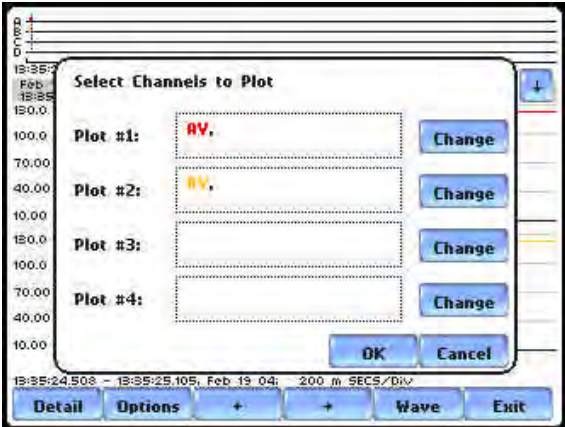
Action...	Result...
<p>STEP 1: From the event screen, press Options.</p> <p>Plot #s appear on the left side of the screen. Users have the option to enable/disable channels for any of the Plot #. The plot display area will resize according to the number of parameters/channels enabled/disabled for display.</p> <ul style="list-style-type: none"> Press the Change button adjacent to the Plot # where you want to change and/or add parameters/channels to plot. <p>For example: Press Change adjacent to Plot #1. Proceed to Step 2 on page 7-16.</p> <ul style="list-style-type: none"> Press OK to accept changes and view new plot display. Press Cancel to ignore changes and return to the event screen. 	 <p>MARK505</p>  <p>MARK511</p>

Continued on next page

View event options (continued)

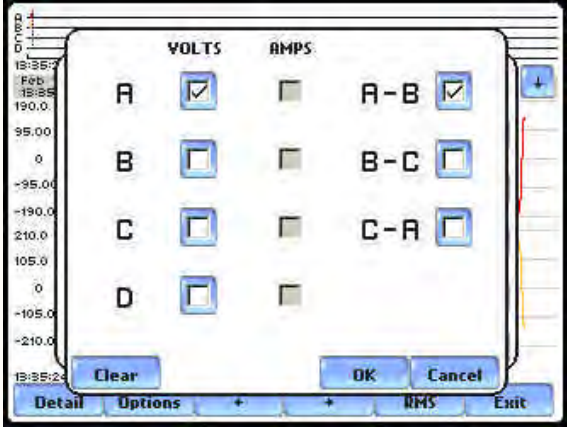
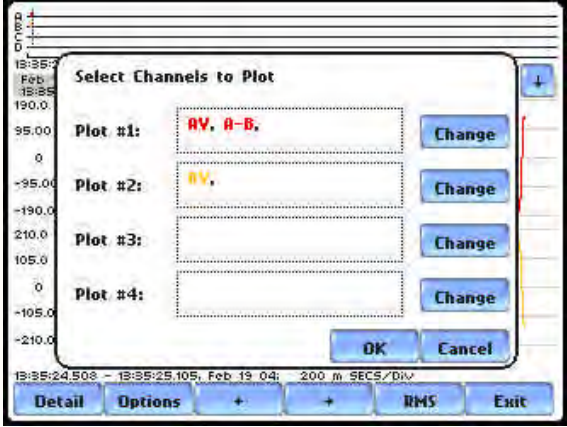
Action...	Result...
<p>STEP 2: Check the channels that you want to enable, uncheck those you want to disable.</p> <p>For example, check to enable Channel A-B Volts, in addition to Channel A Volts for Plot #1.</p> <ul style="list-style-type: none"> • Press OK to accept parameter/channel changes. Proceed to Step 3. • Press Clear if you want to reset channel selection. • Press Cancel to ignore parameter/channel changes and return to the event screen containing the original plot. 	 <p style="text-align: right;">MARK512</p>
<p>Step 3: The parameter/channel changes are reflected in Plot #1.</p> <ul style="list-style-type: none"> • Press OK to accept changes and view event with the new configuration. • Press Cancel to ignore parameter/channel changes and return to event screen with the original configuration. <p>NOTE: The event screen retains the present configuration every time it is accessed. The channel/parameter configuration will reset to default anytime a new monitoring session starts.</p>	 <p style="text-align: right;">MARK513</p>

Section B

Trend

Overview

Trend categories PowerVisa is able to display statistical trends or plots for the following parameter categories:

Standard: Parameters include basic volts and amps, displacement power factor, residual and net current, energy, harmonics, standard demand, and standard flicker. These power parameters are measured more accurately using a one (1) second interval, summarized by min, max and avg at the end of the interval.

Distortion TIF RMS, THD, Frequency: Parameters include voltage and current THD, voltage and current TID, voltage and current TIF rms, crest factor, signed and unsigned harmonic, and transformer factor.

NOTE: See pages 6-17 for the detailed list of parameters available for trending.

In this section The following topics are covered in this section.

Topic	See Page
Trend Display	7-18
Trend Setup	7-19

Trend Display

What is displayed on a trend?

A trend consists of the timed and threshold waveforms for the parameter on display.

Users have the option to enable/disable a trend or plot display, wherein display area will resize according to the number of plots enabled for display. In addition, users have the option to enable/disable channels to trend in a select parameter. Each parameter can have one or multiple channels to plot.

The trend screen also features a Zoom box, wherein users can expand or narrow the size of a zoomed area via touch and drag. The zoom feature allows users to view trend coordinates of min, max and avg values in greater detail.

Sample trend screens

Sample screens below feature the same Voltage RMS parameter.

Example 1 - One Parameter, Multiple Channels plot: Voltage RMS parameter with enabled channels A (in red), B (in yellow), and C (in blue). The plot below has been zoomed in three times.

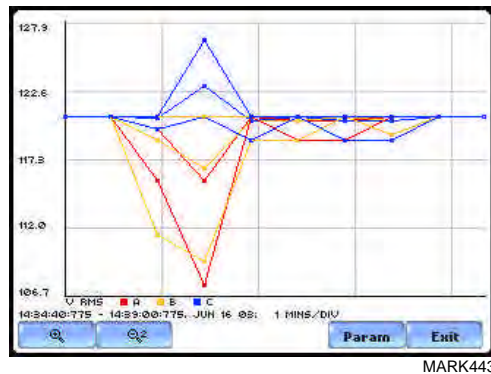

MARK443

Example 2 - One Parameter, One Channel plot: Voltage RMS parameter with enabled channel C (in blue). The plot below has been zoomed in five times.

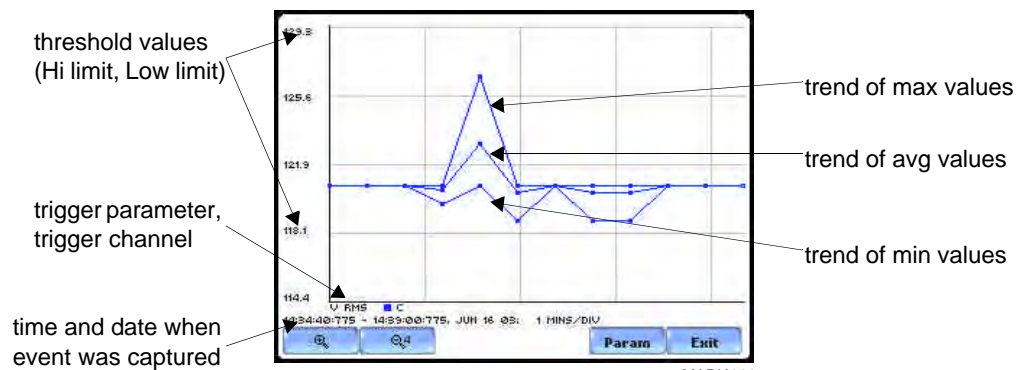

MARK444

Trend Setup

Trend settings Follow these steps to view data trends. The same procedure applies even when you select different journal categories to plot.

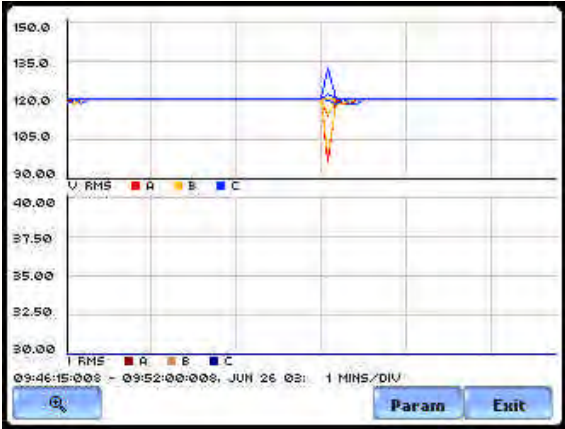
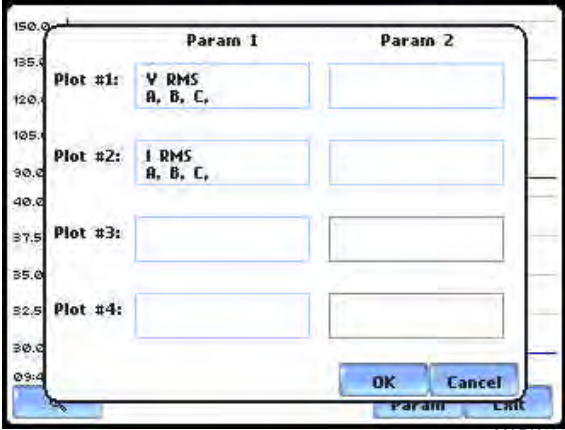
Action...	Result...
<p>STEP 1: From the Home screen, press Trend.</p> <ul style="list-style-type: none"> The default number of plots displayed in the trend screen is two. Press Param to show the current parameters and channels displayed on screen. Proceed to Step 2. Press the Magnify button to use the zoom features and to view plot coordinates in detail. Press Exit to quit and return to Home screen. 	 <p>MARK431</p>
<p>STEP 2: Individual plot numbers appear on the left hand section of the screen. Users have the option to change and/or add parameters/channels to display.</p> <ul style="list-style-type: none"> Press the parameter field that you want to change. <p>For example: Press to change Plot #2 - Parameter 1. Proceed to Step 3 on page 7-20.</p> <ul style="list-style-type: none"> Press OK to accept changes and view plot display. Press Cancel to ignore parameter/channel changes and return to the screen containing the original plot. 	 <p>MARK432</p>

Continued on next page

**Trend settings
(continued)**

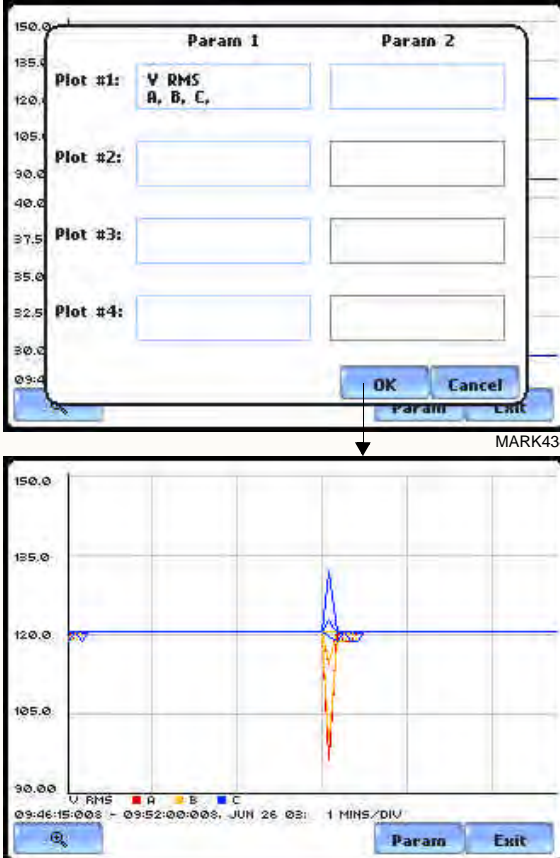
Action...	Result...
<p>STEP 3: The Journal Categories allow users to select parameters/channels to trend for display.</p> <ul style="list-style-type: none"> • Press Disable to clear the parameter display in Plot #2 (from Example in Step 2). Proceed to Step 4. • Users have the option to choose a journal category from which to select parameters/channels to plot. <p>For Standard List - RMS parameters, see RMS Settings on page 7-21.</p> <ul style="list-style-type: none"> • Press Cancel to ignore changes and return to the previous screen. 	 <p style="text-align: right;">MARK433</p>
<p>STEP 4: Parameter/channels on Plot #2 were disabled.</p> <ul style="list-style-type: none"> • Press OK to accept changes and view new plot display. The plot area will resize according to the plot numbers enabled for display. (Whereas the original plot in Step 1 shows Plot #1 and Plot #2 on display, the screen auto-adjusts when parameters in Plot #2 were disabled.) • Press Cancel to ignore parameter/channel changes and return to the screen containing the original plot. 	 <p style="text-align: right;">MARK434</p> <p style="text-align: right;">MARK435</p>

RMS settings

The PowerVisa provides setup options to measure rms data per cycle or per second.

The RMS Voltage and RMS Current parameters are available under Journal Categories - Standard List.

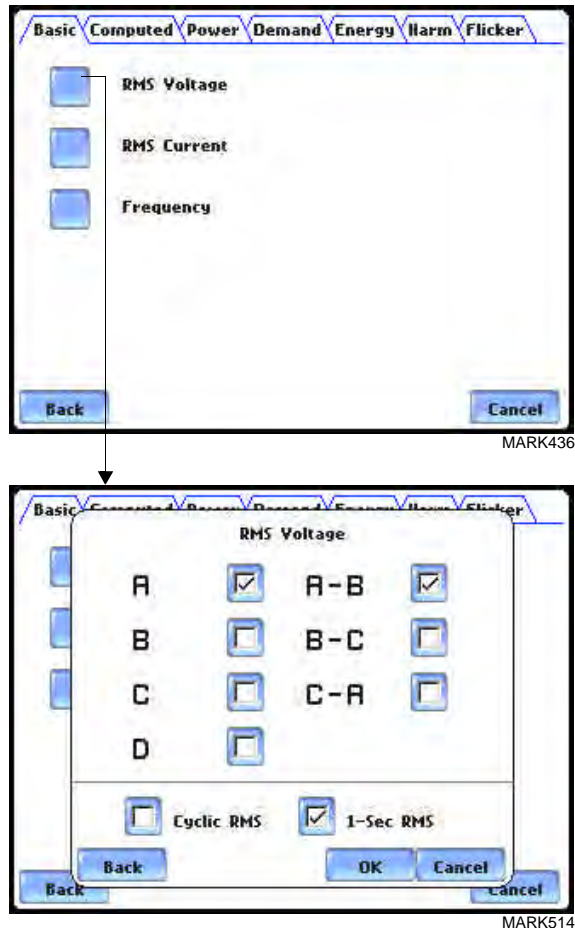

Cyclic RMS: RMS values are computed over 1 power frequency cycle (16.67 msec @ 60 Hz) in 1/2 cycle steps (every 8.33 msec). The min/max/avg of these cyclic values are continually updated and saved every user-programmed journal interval (see Chapter 6 Advanced Setup Options - Journal Interval for Timed Readings on page 6-21).

1-Sec RMS: Similar to cyclic rms, except that each rms value is computed over 1 second's worth of data points (which is 1/60th of a second @ 60 Hz), rather than over 1 cycle.

NOTE: Data for Cyclic or 1-Sec sampling rates apply only to rms parameters.



CHAPTER 8



Reports

Overview

Report types

Users have the option to view QOS compliance reports in two ways: via EN50160 or Status. Each report has their own method of presenting compliance data. Each also differs on the length of evaluation period to monitor compliance. From the Home screen, press Reports.

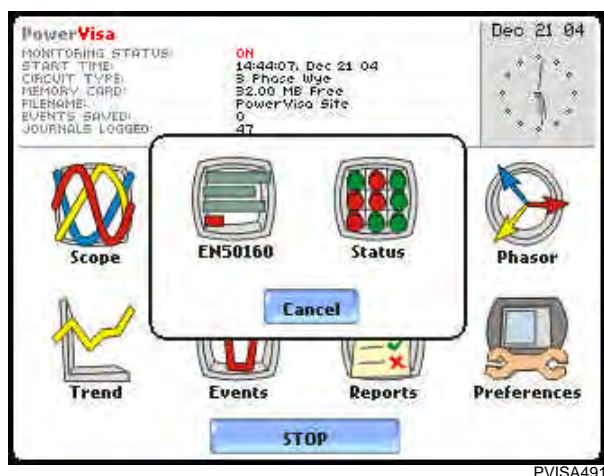

View Reports options

EN50160 displays statistical reports on QOS compliance. Statistical data is calculated on the required parameters specified in EN50160 over a one week interval to produce a PASS/FAIL decision of compliance. The standard monitoring period is one complete week, beginning Sunday 00:00 (midnight). Monitoring periods of less than one week will render an evaluation status that is Incomplete and compliance marked as Undetermined. Press EN50160 to access the EN50160 statistical reports.

Status displays meter data (or event count) in a 2x2, 3x3, or 4x4 matrix. The annunciator panel is also color coded to indicate whether the parameter is within limits. The elements of the matrix are linked to the journal plot screen.

In this chapter

This chapter covers the following topics.

Section	Topic	See Page
A	EN50160	8-2
B	Status Report in Annunciator Panel	8-16

Section A

EN50160

Overview

What is EN50160?

EN50160 is a European standard that stipulates the voltage characteristics that can be expected in public distribution networks. The QOS functionality is equipped with monitoring and setup protocols to meet the measurements required for EN50160 monitoring. EN50160 specifies that various parameters must be within a specified percentage for 95% of the standard one week monitoring period.

EN50160 monitoring mode

EN50160 will be able to display data when the instrument has been configured to monitor EN50160 Power Quality. Refer to Chapter 5 Start Menu - Section B Wizard Setup - Monitoring Mode on page 5-18 for the procedure on how to turn EN50160 Power Quality monitoring on.

In this section

The following topics are covered in this section.

Topic	See Page
EN50160 Measurement Parameters	8-3
EN50160 Compliance Limits	8-5
Compliance Statistical Bar Chart	8-8
Compliance History	8-11
Event Statistics	8-13
Min/Max Table for Power Frequency and RMS Voltage	8-15

EN50160 Measurement Parameters

EN50160 parameters

Statistical data is calculated based on the parameters required by EN50160 for determining QOS compliance. PowerVisa displays the parameters in the form of a Compliance Statistical Bar Chart. From the Reports screen, press EN50160.

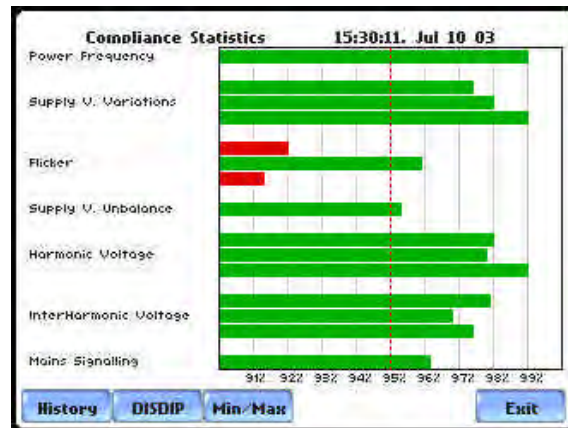

The bar chart indicates the percentage of the intervals passing the specified compliance criteria. The color of the bar indicates the compliance status. A green bar indicates that the parameter is within compliance. A red bar indicates that the parameter does not comply with EN50160 Standard. See below for the description of each measurement parameter. For the QOS compliance limit values of EN50160 parameters, refer to the table of Compliance Limits on page 8-5.

Power Frequency: In case of a fault operation, parts of an interconnected system may become isolated. Compliance will be assessed over an observation period of one week, by a statistical analysis carried out over the sequence of 10 seconds measurement. Frequency is represented by a single value and a single bar. The bar is a hyperlink to the Power Frequency Graph (see page 8-8).

Supply Voltage Variations: Under normal operating conditions, load changes cause variations of the 10 minute average supply voltage. Generally this is compensated by automatic voltage regulation within a period of a few tenths of seconds. Supply Voltage Variations display a cluster of bars, one for each phase. The color of each bar indicates the compliance status for its phase. A green bar indicates that the parameter is within compliance. A red bar indicates the parameter does not comply with EN50160.

Flicker: Typical rapid voltage changes or flicker do not exceed a magnitude of +5% or -5% of the nominal or declared voltage. This limitation is possible because connection of loads capable of creating rapid voltage changes is usually subjected to regulations. However under certain conditions, higher values of up to 10% may occur. These higher values can occur for instance in areas where high power motor equipment (blower,

Continued on next page

**EN50160
parameters
(continued)**

pumps, compressors, etc.) is used. Flickers display a cluster of bars, one for each phase. The color of each bar indicates the compliance status for each phase. A green bar indicates that the parameter is within compliance. A red bar indicates that the parameter does not comply with EN50160.

Supply Voltage Unbalance: The unbalance of a three phase supply voltage consists of a loss of symmetry of the phase voltage vectors (magnitude and/or angle), created mainly by unbalanced load. Compliance is verified when 95% of the sequence of valid 10 minute values are within the specified tolerance of normally 2% (in single phase/two phase supplies 3%). Supply Voltage Unbalance is represented by a single value and a single bar. The color of the bar indicates the compliance status for each phase. A green bar indicates that the parameter is within compliance. A red bar indicates that the parameter does not comply with EN50160.

Harmonic Voltage: Harmonic displays a cluster of bars, one for each phase. The color of each bar indicates the compliance status that is calculated by adding the status of Total Harmonic Distortion (THD) and Harmonics 2 thru 25. The bars for Harmonic Voltage is a hyperlink to the Harmonic graph (see page 8-8).

Interharmonic Voltage: Interharmonic displays a cluster of bars, one for each phase. The color of each bar indicates the compliance status that is calculated by adding the status of Total Interharmonic Distortion (TID) and Interharmonics 2 thru 25. The bars for Interharmonic Voltage is a hyperlink to the Interharmonic graph (see page 8-8).

Mains Signalling: Mains Signalling is represented by a single value and a single bar. The color of the bar indicates compliance status that is calculated by adding the status of each of the defined frequencies (a maximum of five) for its phase. Users can specify the signalling frequency values under Advanced Options (see Chapter 6 Advanced Setup Options - EN50160 Power Quality on pages 6-20 to 6-21). A green bar indicates that the parameter is within compliance. A red bar indicates that the parameter does not comply with EN50160.

EN50160 Compliance Limits

Compliance limits

The table below indicates the limit numbers or range of values required for each parameter to pass QOS compliance and satisfy EN50160 standard.

Parameter	Limits for QOS Compliance to Pass
Un = Low Voltage (LV) Supply nominal voltage, upper limit 1kV Uc = Medium Voltage (MV) Supply Characteristics - declared voltage, range 1kV to 35kV	
Power frequency with synchronous connection to an interconnected system	Mean value over 10 seconds <ul style="list-style-type: none"> • $\pm 1\%$ during 95% of one week • $\pm 4\%$ during 100% of one week
Power frequency with no synchronous connection to an interconnected system	Mean value over 10 seconds <ul style="list-style-type: none"> • $\pm 2\%$ during 95% of one week • $\pm 15\%$ during 100% of one week
Magnitude of the supply voltage (In low voltage systems, declared and nominal voltage are equal)	Mean rms over 10 minutes <ul style="list-style-type: none"> • $\pm 10\%$ of Un or Uc during 95% of one week • $\pm 10\%$ to 15% of Un during 100% of one week
Supply voltage variations (Under normal operating conditions, excluding situations arising from faults or voltage interruptions)	Mean rms over 10 minutes <ul style="list-style-type: none"> • $\pm 0\%$ of Un or Uc during 95% of one week • $\pm 10\%$ to 15% of Un during 100% of one week
Flicker	$Plt \leq 1$ for 95% of the time Also 5% normal, 10% infrequent for LV, 4 & 6 for MV
Supply voltage dips	No criteria specified, just reported in DISDIP table
Short interruptions of the supply voltage	<1 second for 70% of the short interruptions
Temporary power-frequency overvoltage between live conductors and earth	1.5kV for LV 170% for solid or impedance earth, 200% unearthed of resonate earth
Transient overvoltages between live conductors and earth	Short duration surges: <1 us Medium duration surges: >1 to <100 us Long duration surges: >100 us
Supply voltage unbalance (Under normal operating conditions)	10 minute mean rms values of the negative phase sequence component/positive phase sequence component <ul style="list-style-type: none"> • $\leq 2\%$ during 95% each period of one week

Continued on next page

Compliance limits (continued)

The table below indicates the limit numbers or range of values required for each parameter to pass QOS compliance and satisfy EN50160 standard.

Parameter	Limits for QOS Compliance to Pass
Un = Low Voltage (LV) Supply nominal voltage, upper limit 1kV Uc = Medium Voltage (MV) Supply Characteristics - declared voltage, range 1kV to 35kV	
Harmonic voltage (Under normal operating conditions)	10 minute mean rms values Individual Harmonic voltage up to the 25th shall be \leq the value of Un given under Harmonic Compliance Limits (see table below) during 95% of one week • $\leq 8\%$ THD (THD up to the 40th) ≤ 8
Interharmonic voltage	Individual Interharmonic voltage up to the 24th-25th shall be $<$ the value of Un given under Interharmonic Compliance Limits (see table on page 8-8) during 95% of one week • $< 8\%$ TID (TID up to the 39th/40th)
Mains signalling voltage on the supply voltage	3 second mean of signal voltages compared against the Meister curve

Harmonic compliance limit values

The general approach of EN50160 is to express all voltage characteristics by reference to the nominal voltage or declared voltage, as appropriate. The table below indicates the Harmonic Compliance Limit values in relation to the nominal voltage.

Harmonic Number	Limit
DC	
2	2.0%
3	5.0%
4	1.0%
5	6.0%
6 thru 24 (all even nos.)	0.5%
7	5.0%
9	1.5%
11	3.5%
13	3.0%
15	0.5%
17	2.0%
19	1.5%
21	0.5%
23	1.5%
25	1.5%

Continued on next page

Interharmonic compliance limit values

The general approach of EN50160 is to express all voltage characteristics by reference to the nominal voltage or declared voltage, as appropriate. The table below indicates the Interharmonic Compliance Limit values in relation to the nominal voltage.

Interharmonic Group Number	Limit
DC-1	5.0%
1-2	4.8%
2-3	4.6%
3-4	4.4%
4-5	4.2%
5-6	4.0%
6-7	3.8%
7-8	3.6%
8-9	3.4%
9-10	3.2%
10-11	3.0%
11-12	2.8%
12-13	2.6%
13-14	2.4%
14-15	2.2%
15-16	2.0%
16-17	1.8%
17-18	1.6%
18-19	1.4%
19-20	1.2%
All other groups	1.0%

Compliance Statistical Bar Chart

Chart description

The Compliance Statistical bar chart displays the seven parameters that are required for determining QOS compliance. See pages 8-3 to 8-4 for the description of each of the EN50160 parameters. The bar chart indicates the percentage of the interval passing the specified compliance criteria. The color of the bar indicates compliance status. Select bars in the chart i.e. Power Frequency, Harmonic Voltage, and Interharmonic Voltage will further display component details when pressed.

View Compliance Statistics bar chart

Follow these steps to access the EN50160 Compliance Statistical Bar Chart.

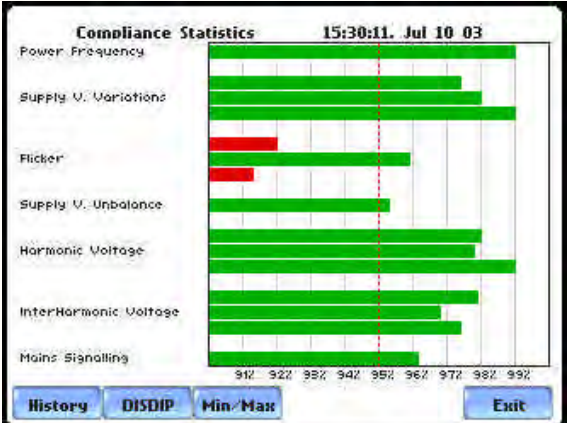
Action...	Result...
<p>STEP 1: From the Home screen, press Reports. Press EN50160 to display the EN50160 statistical reports.</p> <p>The Compliance Statistics bar chart displays the parameters required for determining compliance. A green bar indicates that the parameter is within compliance. A red bar indicates that the parameter does not comply with EN50160.</p> <p>Select bars will show component detail when pressed.</p> <ul style="list-style-type: none"> • Press the Power Frequency bar to view the Power Frequency Graph. Proceed to Step 2 on page 8-9. • Press the Harmonic Voltage bar to view the Harmonic Graph. Proceed to Step 3 on page 8-9. • Press the Interharmonic Voltage bar to view the Interharmonic Graph. Proceed to Step 4 on page 8-10. • Press History to view the Compliance History table. Go to page 8-11. 	 <p>The screenshot shows a bar chart titled 'Compliance Statistics' with a timestamp of '15:30:11, Jul 10 03'. The parameters and their approximate compliance percentages are: Power Frequency (98%), Supply V. Variations (97%), Flicker (92%), Supply V. Unbalance (95%), Harmonic Voltage (98%), InterHarmonic Voltage (97%), and Mains Signalling (96%). The x-axis is labeled with percentages from 91% to 99% in 1% increments. At the bottom of the chart are buttons for 'History', 'DISDIP', 'Min/Max', and 'Exit'. The text 'MARK471' is visible in the bottom right corner of the screenshot.</p>

Continued on next page

View Compliance Statistics bar chart (continued)

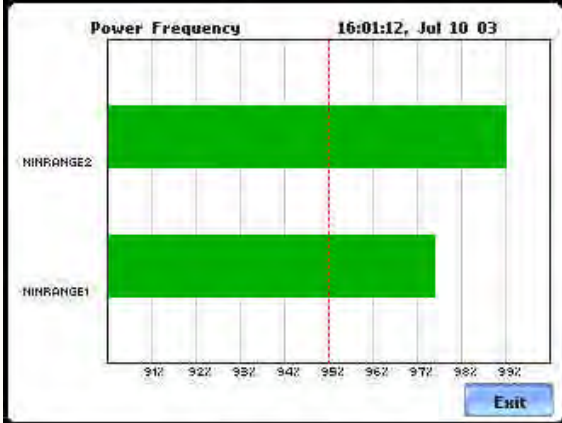
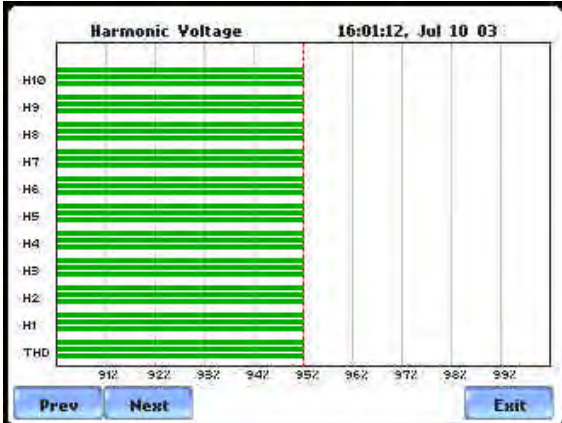
Action...	Result...
<p>STEP 1 (continued):</p> <ul style="list-style-type: none"> • Press DISDIP to view the Event Statistics. Go to page 8-13. • Press Min/Max to view the min/max values for Power Frequency and RMS Voltage. Go to page 8-15. • Press Exit to quit and return to Home screen. 	
<p>STEP 2: The Power Frequency parameter has two ranges considered for compliance. This graph displays the status of parameter with respect to each range. The bar chart indicates the percentage of intervals passing the specified compliance.</p> <ul style="list-style-type: none"> • Press Exit to return to the Compliance Statistical bar chart. 	 <p style="text-align: right;">MARK478</p>
<p>STEP 3: The Harmonic graph displays the status of each of the individual harmonics and THD for each phase. The bar chart indicates the percentage of intervals passing the specified compliance.</p> <ul style="list-style-type: none"> • Press Prev/Next to display Harmonic bars from 1st to 25th. • Press Exit to return to the Compliance Statistical bar chart. 	 <p style="text-align: right;">MARK479</p>

Continued on next page

View Compliance Statistics bar chart (continued)

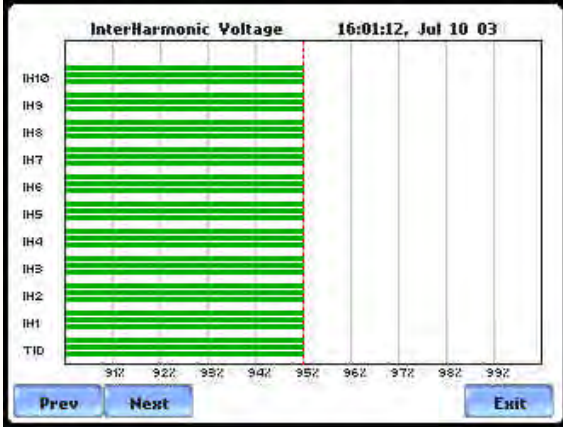
Action...	Result...
<p>STEP 4: The Interharmonic graph displays the status of each individual Interharmonic and TID for each phase. The bar chart indicates the percentage of intervals passing the specified compliance.</p> <ul style="list-style-type: none"> • Press Prev/Next to display Interharmonic bars from 1st to 25th. • Press Exit to return to the Compliance Statistical bar chart. 	 <p style="text-align: right; font-size: small;">MARK480</p>

NOTE

Many instruments used for harmonic measurements of power supply systems express their output with reference to the fundamental component of the voltage, especially those indicating the THD factor.

Harmonic and Interharmonic values are specified only up to order 25 (EN50160 limit), for the practical reason that for higher orders, the values are generally so small as to be impractical to measure. Another reason is because of the difficulty of giving values which would be relevant to all networks.

Compliance History

QOS Status Summary

EN50160 provides a historical summary of the QOS compliance evaluations made. The standard monitoring period is one week, usually beginning Sunday at 00:00 (midnight). Any compliance evaluation performed in less than one week will receive an Evaluation Status marked as Incomplete, and Compliance marked as Undetermined. For completed monitoring periods, Compliance status may either be PASS or FAIL if all of the specified parameters is within limits for 95% or more of the monitoring time period. A PASS or FAIL status is hyperlinked to the Compliance Statistical Bar Chart.

Compliance History table

Compliance History displays a table that summarizes the QOS evaluation status. From the EN50160 screen on page 8-3, press History. The Compliance History table will appear as shown below.

Compliance History				
Evaluation Status	Evaluation Period	Compliance	RMS Event Count	Tran. Event Count
Complete	06/05/03 12:00:01	Pass	0	0
Complete	05/29/03 12:00:01	Fail	5	1

MARK472

scroll through previous/
next items in the list

PASS (green) or FAIL (red) status is linked to
the Compliance Statistical Bar Chart (p. 8-8)

Evaluation Status: The EN50160-specified compliance evaluation period is a 7-day (one week) period. The evaluation status is Complete if monitoring is done within one full week, or Incomplete if monitoring is done in less than one week. An evaluation status is Incomplete under the following scenarios:

- It is the current evaluation period and it has simply not completed.
- It is a previous evaluation period but not enough data samples were included in the statistical analysis. This may be due to the following reasons: data was not collected or too many samples were tagged as unusable due to rms variations.

Continued on next page

**Compliance
History table
(continued)**

Evaluation Period: Displays the date and time of the beginning of the evaluation period. Each evaluation period is independent of each other. The default length of evaluation period is a 7-day week period by which the unit calculates information in strict compliance with the EN50160 standard.

Compliance: Displays a PASS (green) or FAIL (red) mark if evaluation is done for a complete 7-day week period. Compliance displays an Undetermined (black) mark for incomplete periods. A PASS or FAIL compliance status is hyperlinked to the Compliance Statistical Bar Chart that shows the seven parameters required for determining compliance. See Compliance Statistical Bar Chart on page 8-8.

RMS Event Count: Details of rms variation event count are shown in the EN50160 DISDIP table on page 8-13.

Transient Event Count: The complete table for Transient Overvoltages appears in the EN50160 DISDIP table on page 8-14.

Event Statistics

EN50160 DISDIP

The EN50160 DISDIP (distribution of dips) table is based upon the event statistics calculated by EN50160. It includes the UNPEDE DISDIP Statistics and the table for Transient Overvoltages. UNPEDE DISDIP data is collected and saved on a weekly basis with the counts reset as the final save occurs. If additional data is detected for an evaluation period after that period has been saved, that internal data is retrieved and updated.

UNPEDE DISDIP Statistics table

RMS variations shown in the UNPEDE DISDIP table is a filtered version of the Event list. The DISDIP table includes those events of rms variation type (sags, swells, and interruptions). From the Compliance Statistics bar chart screen on page 8-3, press DISDIP. The UNPEDE DISDIP Statistics table will appear as shown below.

DEPTH (%)		DURATION							
FROM	TO	MSEC	SEC	SEC	SEC	SEC	SEC	MIN	MIN
		10<100	1<.5	0.5<1	1<5	5<20	20<60	1<3	>3
DIPS									
0	10	0	0	0	0	0	0	0	0
10	15	0	0	0	0	0	0	0	0
15	30	0	0	0	0	0	0	0	0
30	50	0	0	0	0	0	0	0	0
50	90	0	0	0	0	0	0	0	0
INTERRUPTIONS									
99	100	0	0	0	0	0	0	0	0
TEMPORARY OVERVOLTAGES									
110	120	0	0	0	0	0	0	0	0
120	140	0	0	0	0	0	0	0	0
140	160	0	0	0	0	0	0	0	0
160	200	0	0	0	0	0	0	0	0
200		0	0	0	0	0	0	0	0

MARK473

Display table for Transient
Overvoltage (p. 8-14)

Display DISDIP 3D
Graph (p. 8-14)

RMS Event Count: The table shows rms variations of specified range of magnitude and duration, also called bins. For example, an rms variation with a magnitude of 80-90% of nominal and 1-5 cycles in duration is one bin, whereas 80-90% and 10-30 cycles is another, 70-80% and 10-30 cycles is another, and so on. Each time that the characteristics of an rms variation match the criteria of the bin, the counter is incremented. RMS phenomena are typically found in bin groupings such as:

- DIPS - classified in 5 Magnitudes x 8 Durations
- Interruptions - classified in 1 Magnitude x 8 Durations
- Temporary Overvoltages - classified in 5 Magnitudes x 8 Durations

Continued on next page

**UNIPEDE
DISDIP
Statistics table
(continued)**

The DISDIP table also includes those events of Transient type. Scroll down the next page of the UNIPEDE DISDIP Statistics table to display data for Transient Overvoltage as shown below.

Transient Overvoltage		Counts
110	120	0
120	140	0
140	160	0
160	200	0
200		0

Display table for RMS Events (p. 8-13)

Display DISDIP 3D graph (see below)

Transient Event Count: Transient phenomena are typically found in bin groupings such as:

- Transient Overvoltage - classified in 5 Magnitudes x 1 Count

The EN50160 DISDIP 3D Graph is an object representation of the table for rms variations found in page 8-13. The graph offers a quick and visual way to see what category most of the rms disturbances fall into, whether as Dips, Interruptions, or Temporary Overvoltages.

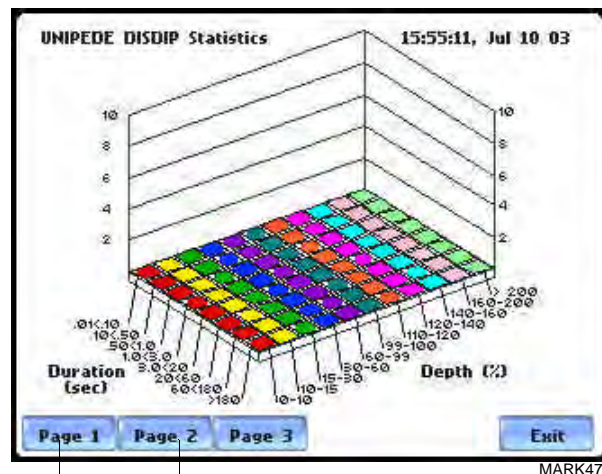

Display table for RMS Events (p. 8-13)

Display table for Transient Overvoltage (see above)

Min/Max Table for Power Frequency and RMS Voltage

Min/Max table The Min/Max table displays the minimum and maximum values for Power Frequency and RMS Voltage along with the time and date of occurrence. Maximum phase values of Rapid Voltage Change, Flicker, Supply Voltage Unbalance, and Harmonic are also displayed along with time and date of occurrence.

From the Compliance Statistics bar chart screen on page 8-8, press Min/Max. The Min/Max table will appear as shown below.

	Min	Max
Power Frequency	49.68	49.68
- V Unbalance (S2/S1)	Jun 23 04 16:20:00	Jun 23 04 16:20:00
Magnitude of Supply Voltage - Vrms	0.98	120.27
	Jun 23 04 16:20:00	Jun 23 04 16:20:00

Max Values	Phase A	Phase B	Phase C
Rapid Vrms Change	120.27	0.98	120.26
	Jun 23 04 16:20:00	Jun 23 04 16:20:00	Jun 23 04 16:20:00
Flicker (plt)	0.00	0.00	0.00
	Jun 23 04 16:20:00	Jun 23 04 16:20:00	Jun 23 04 16:20:00

Prev Next Exit

MARK476

Harmonic #	Phase A	Phase B	Phase C
THD	7.60	0.88	0.05
	Jun 23 04 16:30:00	Jun 23 04 16:20:00	Jun 23 04 16:30:00
2	1.65	0.00	0.00
	Jun 23 04 16:30:00	Jun 23 04 16:20:00	Jun 23 04 16:20:00
3	1.30	0.01	0.02
	Jun 23 04 16:30:00	Jun 23 04 16:20:00	Jun 23 04 16:30:00
4	1.24	0.00	0.00
	Jun 23 04 16:20:00	Jun 23 04 16:20:00	Jun 23 04 16:20:00
5	1.40	0.00	0.02
	Jun 23 04 16:20:00	Jun 23 04 16:20:00	Jun 23 04 16:30:00

Prev Next Exit

MARK477

press to show Harmonic values up to order no. 25

Section B

Status Report in Annunciator Panel

Overview

Annunciator panel

Status summary for three report types - Standard PQ, EN50160, and Motor Quality - can be displayed via the annunciator panel. Real time data, event count, or user-specified calculated data is available in the matrix display of the annunciator panel. When monitoring is on, the annunciator panel displays the status of a parameter using a color scheme. Journal data and events can be directly viewed from the annunciator panel.

For example:

From the Reports screen, press Status. The annunciator panel will display Standard PQ preset parameters by default (shown below).

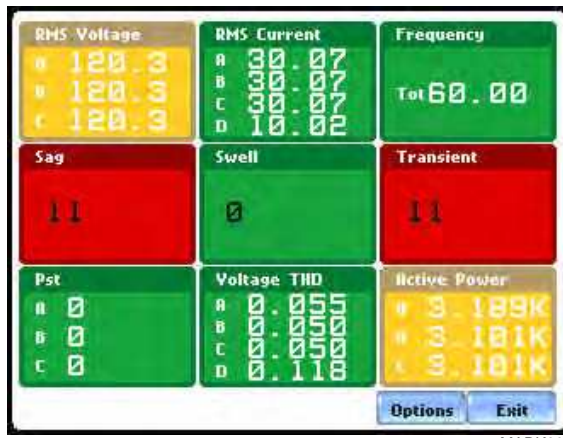

NOTE: Where applicable, the values reported within a parameter in the panel refer to measurements on channels A, B, C, and D respectively. The measurement values for each channel are updated approximately once per second while monitoring is on.

In this section

The following topics are covered in this section.

Topic	See Page
Panel Setup Options	8-17
Panel Operation	8-19

Panel Setup Options

Setup options Press **Options** to select the Preset parameters and/or Panel Size to display.

Presets provide a set of default parameters that will be displayed in the annunciator panel. The screen matrix size can also be customized (Small, Medium or Large) according to user application.

The sample screens below show preset parameters for Motor Quality setup.

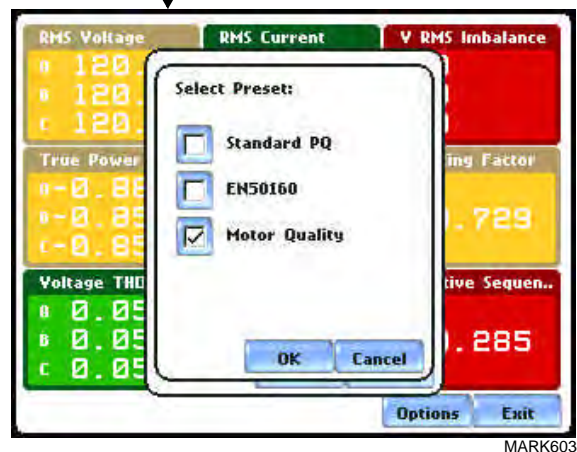
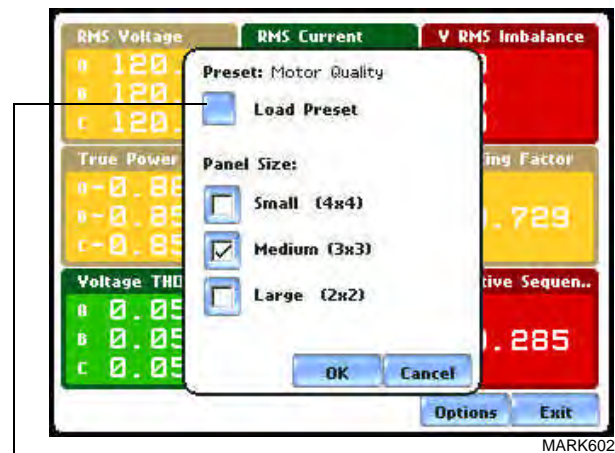

The following are the three different presets available:

Standard PQ uses the standard power quality parameters based on IEEE 1159 PQ standard. This includes basic power parameters such as volts, amps, watts, event counters, THD, and flicker.

EN50160 displays parameters as specified by the EN50160 standard.

Motor Quality displays parameters that affect the operation of motors.

Preset parameters

The table below shows the default parameters on display in the annunciator panel. Note however that you can edit and change the parameter settings using the Edit Panel function described on page 8-22.

Setup	Parameters		
Standard PQ	RMS Voltage Sag Pst	RMS Current Swell Voltage THD	Frequency Transient Active Power
EN50160	RMS Voltage Sag Pst	Frequency Swell Voltage THD	V RMS Imbalance Transient Current THD
Motor Quality	RMS Voltage True Power Factor Voltage THD Fund	RMS Current Horsepower Current THD Fund	V RMS Imbalance Derating Factor Negative Sequence Current

Panel Operation

Annunciator panel color scheme

The annunciator panel displays metered data for the selected parameter. The metered data is updated once per second. This is the same data that appears in the meter screen, and used in calculating journals. If the selected parameter is not journalled, the rms event or transient event count can be selected to appear in the panel instead of journalled data.

Disabled parameters appear in gray. A panel is considered disabled if none of the limits were set.

Enabled parameters, on the other hand, are color-coded. A panel is active while the instrument is monitoring or by loading a previously saved file from the data card. An active panel can have two or three states (Normal, Moderate, or Severe). When monitoring, parameters that are within limits are shown in green (indicates Normal state). Those that are moderately out of limits, exceeding the Low or High threshold limits, are shown in yellow (indicates Moderate state). Parameters that are extremely out of limits, exceeding the Very Low or Low threshold limits, are shown in blinking red (indicates Severe state).

Annunciator panel links

Users may choose to plot a parameter since the panel is linked to the plot screen. Simply select the parameter if you want to view it in detail. Use View Graph to display the parameter plot and use View Limits to view the parameter threshold values.

The properties of a panel can also be customized. Use Edit Panel to enable/disable channels to plot.

The next pages show how to view a parameter in detail using the annunciator panel. The same procedure applies even when you select different journal categories to plot.

Parameter data plot The following procedure describes how to view parameter details in the annunciator panel.

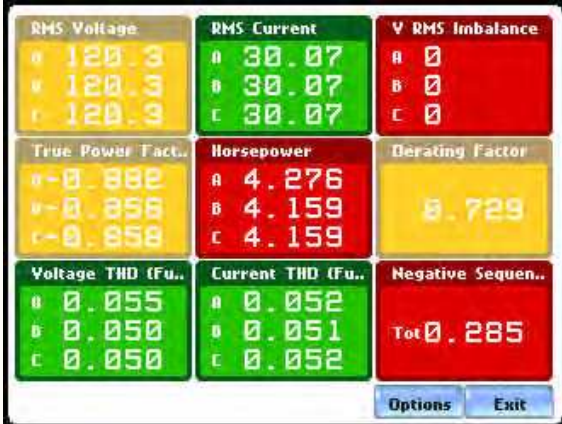
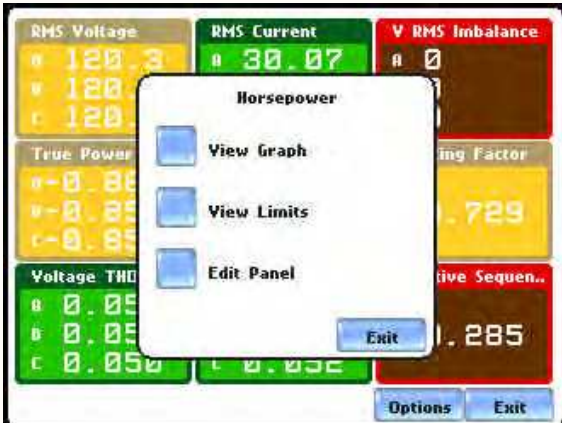
Action...	Result...
<p>STEP 1: From the Home screen press Reports. Select Status to display the summary report via the annunciator panel.</p> <p><u>FOR EXAMPLE:</u> The summary report type described here is for Motor Quality setup. Click on V RMS Imbalance to view the parameter in detail. Proceed to Step 2.</p>	 <p style="text-align: right;">MARK608</p>
<p>STEP 2: Press to select the parameter that you want to view in detail.</p> <ul style="list-style-type: none"> • Press View Graph to display the data plot for V RMS Imbalance. Proceed to page 8-21. • Press View Limits to display the threshold values crossed. Proceed to page 8-22. • Press Edit Panel to display the tab function where you can disable/enable parameters/ channels to plot. Proceed to page 8-22. 	 <p style="text-align: right;">MARK609</p> <p>NOTE: An activity indicator periodically appears in the middle of the screen signifying that data monitoring is on and the unit is actively characterizing events and searching database.</p>

Continued on next page

Parameter data plot (continued)

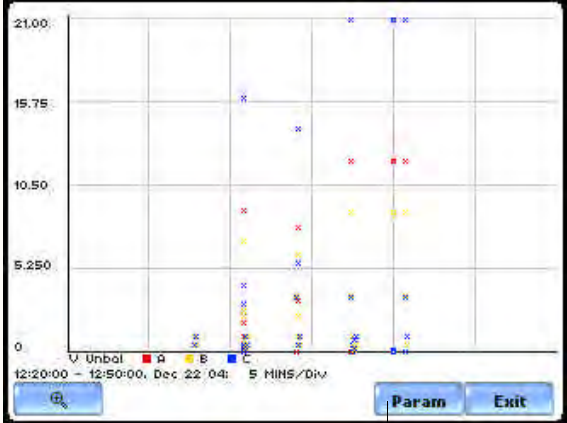
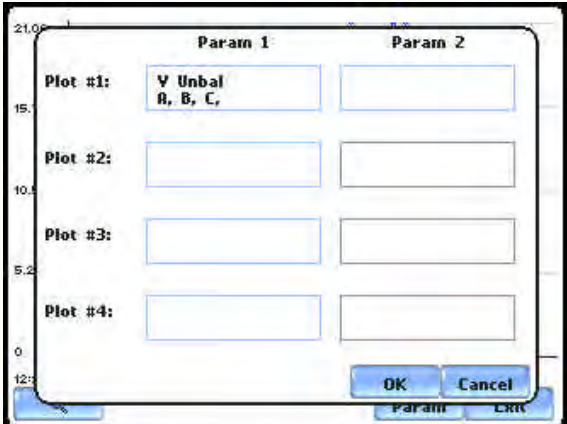
Action...	Result...
<p><u>FOR EXAMPLE:</u> Once View Graph is selected, coordinates for V RMS Imbalance event are displayed on screen.</p> <p><u>NOTE:</u> Imbalance is the rms deviation calculation per channel if the instrument is in Standard PQ Mode. It will display the ANSI definition of unbalance for channels A, B and C if the selected monitoring mode is other than EN50160. When monitoring under EN50160 mode, Imbalance will be a simple value as per IEC definition, defined as the sum of negative sequencing components divided by the sum of positive sequencing components (similar to meter readings under Meter Mode).</p> <ul style="list-style-type: none"> • Press the Magnify button to use the zoom features and to view plot coordinates in detail. • Press Param to show the trigger parameter and channel/s displayed on screen. • Press Exit to return to the PQ Status screen. 	 <p>MARK610</p>  <p>MARK611</p>

Continued on next page

Parameter data plot (continued)

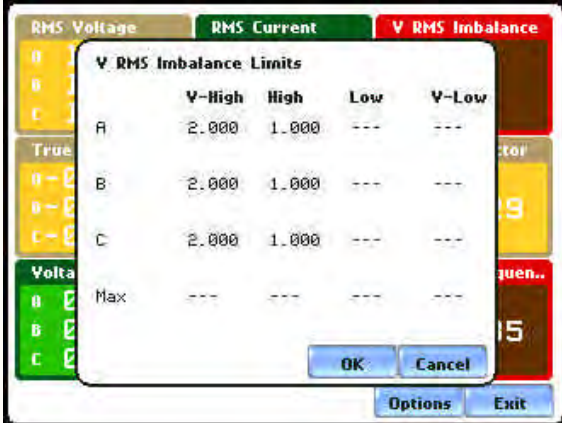
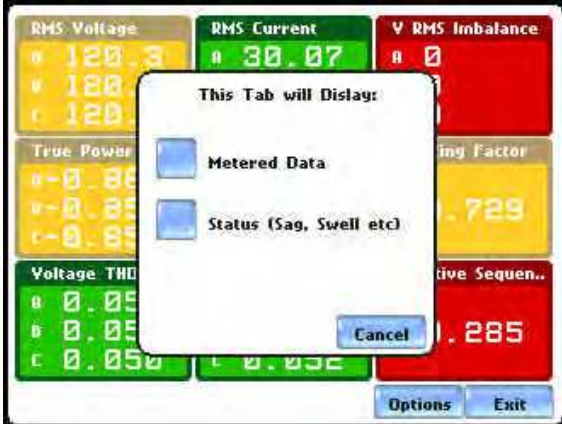
Action...	Result...
<p>Once View Limits is selected, threshold values crossed that cause the V RMS Imbalance event are displayed on screen.</p>	 <p style="text-align: right;">MARK612</p>
<p>Once Edit panel is selected, the window where you can select Metered Data journal categories to plot is displayed.</p> <p>You can also view the trend plot for sag, swell, and transient by pressing the Status button.</p>	 <p style="text-align: right;">MARK613</p>

CHAPTER 9



Downloading Events

Overview

In this chapter PowerVisa allows users to download, archive and view event data in a computer. This section discusses the external communications device and software applications necessary to transfer and store PowerVisa data files to a computer.

Topic	See Page
External Communication Interface	9-2
Connection Setup via RS232	9-3
Connection Setup via USB	9-4
Connection Setup via Ethernet	9-5
Connection Setup via Modem	9-6
Downloading Events via NodeLink®	9-10
Viewing Events via DranView®	9-11
DranView® with HASP	9-12

External Communication Interface

Isolated Communications Module

To download events from the PowerVisa through the optical port, you must have the following: a personal computer or laptop with Windows® operating system with either RS232 serial port or network adapter, NodeLink®, and the appropriate Isolated Communications Module assembly as described below.

The Isolated Communications Module assembly consists of two parts:

1. A fiber optic cable (P/N 900406) which connects the PowerVisa optical serial port to the communication module;
2. The PowerVisa communication module which is available in three types:
 - a 9-pin RS232 Communication Module (P/N COMM-RS232)
 - a USB Communication Module (P/N COMM-OUA)
 - an Ethernet Communication Module (P/N COMM-OEA)

The PowerVisa communication modules are optically isolated devices using infrared light to transfer text and graphics to a computer running NodeLink®. These modules are designed to connect the PowerVisa optical serial port to the appropriate interface - either a standard RS232 serial port connector, USB adapter, or Ethernet adapter.

With NodeLink® you will be able to download data, upload or download instrument setups, or view real time meter data from the PowerVisa. The downloaded data can be viewed using the DranView® application.

Each adapter interface is supported using the computer's standard serial ports.

Connection setup via RS232

The following procedure and diagram describe how to connect the PowerVisa to a computer via RS232. Once the physical connection is done, see Chapter 4 Instrument Settings - Communications on page 4-10 for instructions on how to enable the PowerVisa settings to communicate with external devices.

1. Connect one end of the fiber optic cable (P/N 900406) into the Fiber Optic Serial Data Port located on the left side panel of the PowerVisa.
2. Connect the other end of the fiber optic cable into the Fiber Optic Port on the plastic housing of the 9-pin/RS232 Communication Module (P/N COMM-RS232).
3. Connect the 9-pin RS232 connector to any available serial COM port on your computer.

NOTE: If the RS232 COM port on your computer supplies voltage power, the battery charger/UPS for DC power input is not required. Otherwise, COMM-RS232 requires that an external power source be connected. For external power supply, use the optional accessory Battery Charger/UPS (P/N XBC-PX5) available from Dranetz-BMI. Connect the DC plug from the battery charger/UPS to the 12V, 3W max input jack on the RS232 adapter. Configure the AC power plug of the battery charger by sliding the proper plug supplied (US, Euro, UK or Australia) and locking it into place. Connect the AC power plug of the battery charger to the proper power source 120V AC for US type plug or 230V AC for Euro, UK or Australia type plug.

4. Refer to the NodeLink® User's Guide (P/N UG-NODELINK) for instructions on how to set up a NodeLink site.

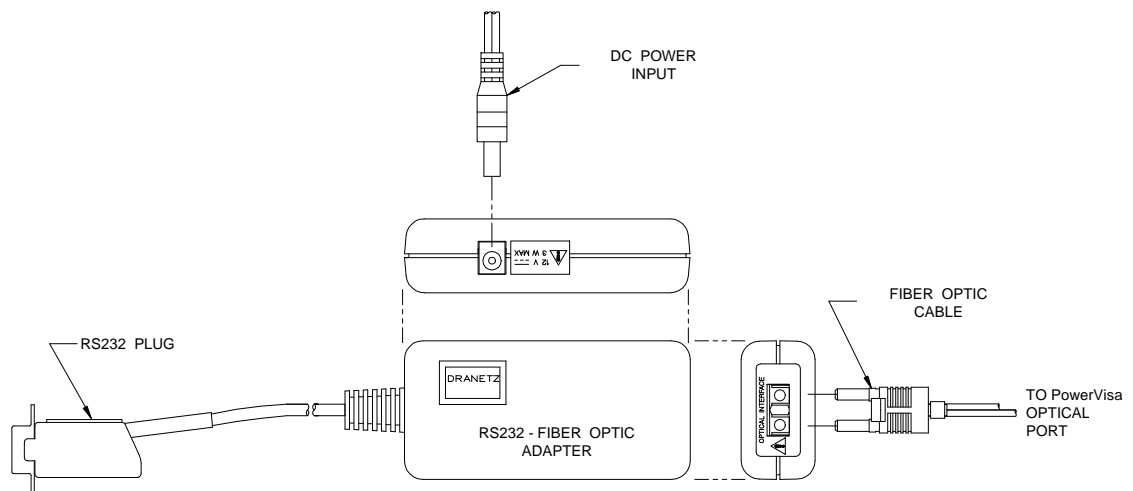

Connection setup via USB

The following procedure and diagram describe how to connect the PowerVisa to a computer via USB. Once the physical connection is done, see Chapter 4 Instrument Settings - Communications on page 4-10 for instructions on how to enable the PowerVisa settings to communicate with external devices.

1. Connect one end of the fiber optic cable (P/N 900406) into the Fiber Optic Serial Data Port located on the left side panel of the PowerVisa.
2. Connect the other end of the fiber optic cable into the Fiber Optic Port on the plastic housing of the 9-pin/RS232 Communication Module (P/N COMM-RS232).
3. Connect the 9-pin RS232 connector to the USB to RS232 Serial Adapter.
4. Install the software on the compact disc that came with your USB to RS232 Serial Adapter. This will create a virtual COM port on your computer at the next available serial port.
5. Connect the USB cable from a USB port on your computer to the USB socket of the RS232 Serial Adapter.
6. Check the Device Manager in the Windows® control panel to identify the new COM port number created by the USB - RS232 Serial device. Use this COM number to connect the PowerVisa with NodeLink®.
7. Refer to the NodeLink® User's Guide (P/N UG-NODELINK) for instructions on how to set up a NodeLink site.

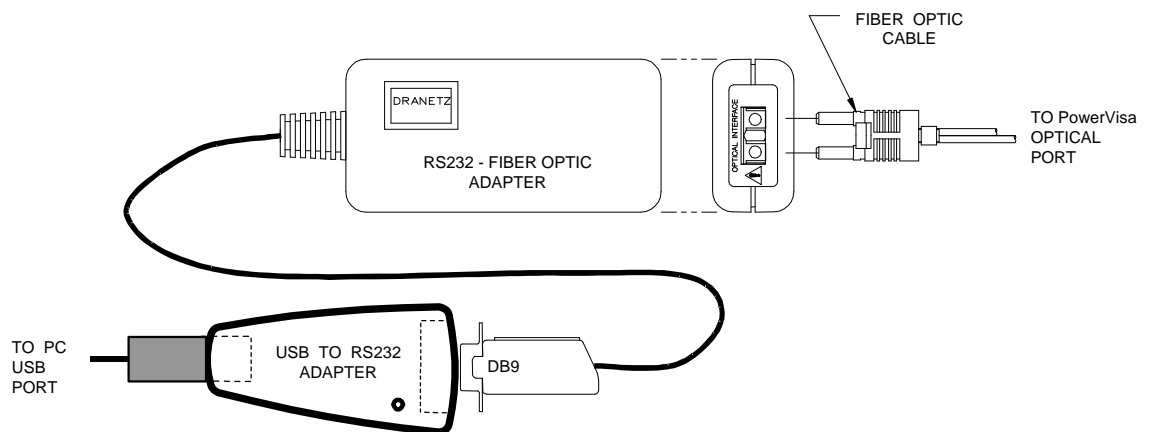

Connection setup via Ethernet

The following procedure and diagram describe how to connect the PowerVisa to a computer via Ethernet. Once the physical connection is done, see Chapter 4 Instrument Settings - Communications on page 4-10 for instructions on how to enable the PowerVisa settings to communicate with external devices.

1. Connect one end of the fiber optic cable (P/N 900406) into the Fiber Optic Serial Data Port located on the left side panel of the PowerVisa.
2. Connect the other end of the fiber optic cable into the Fiber Optic Port on the metal housing of the Ethernet Communication Module (P/N COMM-OEA).
3. The COMM-OEA requires connection to an external power source. Connect the DC plug from the AC adapter supplied (P/N 11707-G1) to the 12V, 3W max input jack on the Ethernet adapter. Configure the AC power plug of the battery charger by sliding the proper plug supplied (US, EURO, UK or Australia) and locking it into place. Plug the AC power plug of the battery charger to the proper source 120V AC for US type plug or 230V AC for Euro, UK or Australia type plug.

NOTE: For battery backup operation, replace the AC adapter with the optional accessory Battery Charger/UPS (P/N XBC-PX5) available from Dranetz-BMI.

4. Set the IP configuration of the Ethernet Communication Module. Consult your IT Department for the appropriate setting of your local area network. See Chapter 4 Instrument Settings - Communications on page 4-10 for the procedure on how enter IP settings in the PowerVisa.
5. Connect the Ethernet port on the Ethernet Communication Module to the local area network to which your computer is connected to.
6. Install the software contained in the compact disc that came with your Ethernet Communication Module. This will install the “Real COM Installer Program” plus some utility programs from MOXA Technology, Inc.® for the Ethernet Communication Module on your computer.
7. Run the Real COM Installer. Map and activate a COM port to the first available COM port on your computer.
8. Refer to the NodeLink® User’s Guide (P/N UG-NODELINK) for instructions on how to set up a NodeLink site.

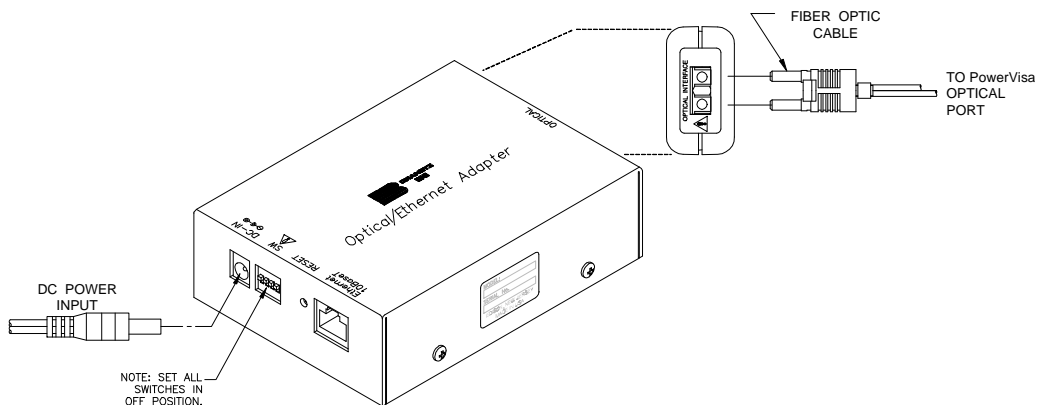

**Connection
setup via
Modem**

When configuring both the PowerVisa and NodeLink® for modem communications, keep in mind that the PowerVisa uses a fiber optic serial port in order to maintain electrical isolation. This means that there are no control signals available to a modem to use for handshaking and flow control.

It is highly recommended that identical modems be used on the PowerVisa and the computer. Identical modems will have the same internal buffering and are more likely to negotiate modulation, speed, and error correction suitable to both modems. If the modems used are not identical then both the PowerVisa and the computer should have modems with the same chipset (i.e. Rockwell, Lucent).

When configuring for modem communications, the first decision to be made is the port speed for both ends of the communications link. This is the speed at which the PowerVisa communicates with its modem and the speed at which the computer communicates with its modem. The same speed should be chosen for both. Ideally the speed should be at or just below the anticipated modem connect speed. Since most modems today will attempt to connect at least at 56 kbps, 38.4 kbps would be a good choice for the two port speeds. This helps to prevent possible modem buffer overflow.

Follow the steps below to configure the PowerVisa for a port speed of 38.4 kbps. See Chapter 4 Instrument Settings - Communications for the PowerVisa screen interface.

1. Connect the modem to the PowerVisa communications adapter.
2. Turn on the modem.
3. From the PowerVisa home screen, click on the **Preferences** icon.
4. Choose **Communications** from the **Instrument Settings Setup Menu**.
5. Verify that both the **Enable Communications** and **External Modem Connected** checkboxes are enabled (checkboxes checked).
6. Check to enable **38400** under **Baud Rate (bps)**.
NOTE: The port speed of 38400 (38.4 kbps) used above may be substituted with 57600. Experiment to find the maximum port speeds that will work for the system.
7. Note the modem initialization string at the bottom of the screen. Do not exit this screen yet since you may be modifying this string after you have the Windows® modem configured.

Continued on next page

**Connection
setup via
Modem
(continued)**

NodeLink® uses Windows® TAPI when accessing modem communications resources. The assumption is that the Windows® modem to be used for PowerVisa communications has been properly installed prior to executing this procedure.

If the modem is not on, or was not on when Windows® was started, it may be necessary to turn the modem on and restart Windows®. Windows® searches for installed serial modems at startup. If it does not find them, it may not allow them to be configured in the Control Panel.

Follow the steps below to configure the port speed for the Windows® modem in the computer:

1. Press the **Start** button.
2. Select **Settings** and then **Control Panel**.
3. Double-click on **Phone and Modem Options**.
4. Select **Modems** in the subsequent dialog box.
5. In the list of modems that is displayed, click to highlight the modem in question and select **Properties**.
6. On the **General** tab of the modem properties dialog box, select **38400** as the maximum port speed.
7. Click **OK** to exit from the open dialog boxes.
8. Close the Control Panel.

It is important to note that the port speed of 38400 (38.4 kbps) may be substituted with 57600. Experiment to find the maximum port speeds that will work for the system.

Continued on next page

Connection setup via Modem (continued)

Back at the PowerVisa, the last step in configuring the modem communications is to modify the modem initialization string to match the modems and chipsets being used. The goal is to configure for the following:

- Restore factory settings.
- Set auto-answer to answer on one or two rings (more than two rings are allowed but at some point the number of rings may start to conflict with NodeLink® timeouts).
- Turn hardware flow control off since you are using a "two-wire" connection (fiber optic port).
- Set a modem inactivity timeout of 60 seconds. The modem will hang up after one minute of continuous inactivity on the line.
- Select the minimum allowable baud rate.

Follow the steps below to change the modem initialization string. See Chapter 4 Instrument Settings - Communications for the PowerVisa screen interface.

1. From the PowerVisa **Communications Settings** screen used to configure modem connection speed, click on the **Change** button to the right of the string field display.
2. Use the virtual keypad that appears on the screen to change and enter the new string command. The modem initialization string commands for the Conexant (Rockwell) chipset and the Agere (Lucent) chipset are discussed in the next section.
3. When done, click on **OK** to accept changes in modem communications settings.

Modem initialization string command

The following is the AT initialization string for a modem using the newer Conexant (Rockwell) chipset:

```
AT&F;S0=2;+IFC=0,0;S30=6
```

Where:

AT is the modem attention command

&F instructs the modem to restore factory configuration

S0=2 turns auto-answer on and sets the number of rings to answer to two.

+IFC=0,0 turns flow control off.

S30=6 sets a 60 second inactivity modem hang up timeout.

; is a command delimiter.

NOTE: It may be necessary to adjust the modem connection speeds to specify a minimum baud rate. This is possible using the +MS modem command. Check the modem manual for use of the +MS command. There are several varieties of the command. Typically, a modem modulation scheme and minimum and maximum transmit and receive speeds can be specified. Using Hyperterminal, it is possible to get a list of the possible command ranges and syntax by typing AT+MS=?.

Continued on next page

**Modem
initialization
string command
(continued)**

The following is the AT initialization string for a modem using the Agere (Lucent) chipset:

```
AT&F;S0=2;&K0;%E0;S30=6
```

Where

AT is the modem attention command.

&F instructs the modem to restore factory configuration.

S0=2 turns auto-answer on and sets the number of rings to answer to two.

&K0 turns flow control off.

%E0 disables baud rate fall back/fall forward.

S30=6 sets a 60 second inactivity modem hang up timeout.

; is a command delimiter.

A similar note regarding connect speeds applies. Try using the AT-V90= command and modifying the contents of S registers S37 and S38.

Downloading Events via NodeLink®

NodeLink® application

NodeLink® is a Windows®-based program enabling the user to download, archive and visualize (using DranView®) event-type data from a variety of Dranetz-BMI instruments including the PowerVisa.

Users are strongly advised to always keep their NodeLink® and PowerVisa programs current with the latest version released by Dranetz-BMI. NodeLink V2.5 or higher is required to download events from PowerVisa firmware.

Log on to the Dranetz-BMI website, www.dranetz-bmi.com, to download the latest PowerVisa firmware version. See Chapter 1 Getting Started - Upgrading Firmware from a Data Card on page 1-10 for instructions on how to download and install the latest PowerVisa firmware upgrade from the web. Contact the Dranetz-BMI Customer Service Department for further information and assistance on upgrading the PowerVisa firmware.

NodeLink® communicates directly with the PowerVisa using the external communications devices described on pages 9-2 to 9-9. Depending on the communication assembly used, NodeLink® can communicate with the PowerVisa either by RS232 serial port, USB, Ethernet, or modem connection.

Data files downloaded by NodeLink® can then be seamlessly transferred to a viewer application such as DranView®.

Contact the Dranetz-BMI Customer Service Department at (732) 287-3680 or 1-800-372-6832 for more details on how to get a copy of the NodeLink® and DranView® applications. Refer to the NodeLink® User's Guide (P/N UG-NODELINK), included in the NodeLink® software package, for instructions on how to set up a NodeLink site.

Viewing Events via DranView®

DranView® with PowerVisa driver

DranView® is an optional viewer and data analysis software. Data collected by the PowerVisa must first be transferred to a computer via NodeLink® so that they can be archived and/or viewed using DranView®.

Users are strongly advised to always keep their DranView® and PowerVisa programs current with the latest version released by Dranetz-BMI. DranView® V5.8 or higher with PowerVisa driver is required when using PowerVisa firmware in the computer:

DranView® is available in soft key version (without HASP) and in hard key version (with HASP).

DranView® soft key version does not require a hardware lock or HASP in order to work properly in a computer.

DranView® hard key version can be installed in multiple computers, but can only be used in a computer where a HASP driver is properly installed. A HASP is available for installation to either the USB port or the Printer/Parallel port.

IMPORTANT: BEFORE ATTEMPTING TO INSTALL DRANVIEW WITH HASP, READ THE INSTRUCTIONS FOUND ON PAGE 9-12 AND/OR THE INSTALLATION GUIDE THAT CAME WITH YOUR DRANVIEW® SOFTWARE PACKAGE.

DranView® application

DranView® is a Windows® 98/NT/2000/XP compatible program that is used to access and retrieve files from a data card or from other disk media compatible with MS-Windows® operating system. Following are the features and highlights of the DranView® application:

- Direct interface with NodeLink® communications software
 - Two-pane browser (timeplots and waveforms simultaneously)
 - Multiple ZOOM levels (up to 15 times)
 - Advanced Harmonic analysis (DFT/FFT) featuring phasor diagrams and flexible data presentation
 - Toolbar and Button support
 - Drop-down Events list
 - Multi-parameter time plots
 - Time measurement tool (delta measurement)
 - Saves data to .DNV (DranView® compressed format) or converts to ASCII
 - Status bar displays time, date and selected pane parameters
 - Accelerator keys and right mouse button support
 - Cut and paste to other applications
 - Email .DNV data files directly from DranView®
-

DranView® with HASP

DranView® system requirements

The minimum system specifications for proper installation and operation of DranView® are shown below. Users are strongly advised to follow the **recommended** specifications for optimal DranView® operation. The recommended specifications are especially encouraged for use with instruments that allow generation of very large databases i.e. PX5, PGPowerVisa0, and PP4300 Multi-DAQ. The Compact Flash storage media in these instruments are able to handle very large files.

Operating System	MS Windows® 95, 98 SE, NT 4.0, ME; Win 2000 or Win XP recommended
Processor	Pentium class or higher
Clock Speed	133 MHz or higher
Memory	128 MB or higher; 512 MB or higher recommended
Disk Requirements	12 MB disk space for installation 128 MB disk free space for file conversion; 512 MB disk free space for file conversion recommended
Monitor	VGA or better; Hi-color 800x600 or higher recommended

Installation procedure

The DranView® with HASP software package includes the HASP and the CD-ROM containing the DranView® program and the User's Guide.

WARNING: DO NOT insert the HASP before installing DranView®. Otherwise, MS Windows® will fail to find the proper driver for the HASP but may still add a non-working HASP driver to the Device Manager (Control Panel System). In this case, the HASP driver needs to be manually removed from the Device Manager. When done, restart the computer and reinstall DranView® from the CD-ROM.

NOTE: If you are running MS Windows® NT, ME, 2000 or XP, you must have administrator privileges to do a proper install.

STEP 1: Install the DranView® program from the CD-ROM. Follow the instructions below to install DranView.

- Insert the CD-ROM with the DranView® program in the disc drive.
- Auto Run will automatically start to install DranView®.
If not, click the START button and select RUN. Type d:\setup (or whatever disc drive DranView is inserted), and press ENTER.
- Follow the on-screen instructions to continue installing DranView®.

Continued on next page

Installation procedure (continued)

STEP 2: There are two types of HASP available: one which can be keyed to the USB port and another which goes into the Printer or Parallel port (see figure below). Depending on type of HASP, insert in the appropriate USB port or Printer/Parallel port in the computer. Align the HASP to the keyed port and push gently to lock it in place. Keep the HASP in the port while using the DranView® application.

The HASP is programmed to allow DranView® to work with a specific Dranetz-BMI product. The table on page 9-14 lists the HASP ID labels that go with the corresponding Dranetz-BMI product.

NOTE: Make sure to write down the serial number of your HASP and keep this information in a secure place. The serial number is required to replace HASP in case it gets lost or destroyed.

HASP for USB Port

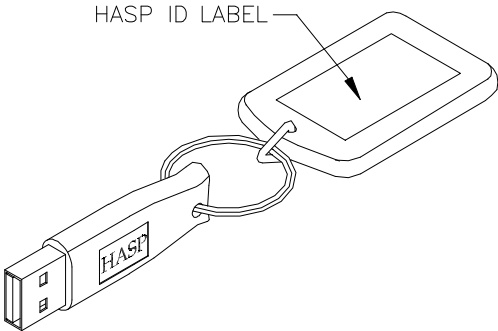

HASP for Printer or Parallel Port

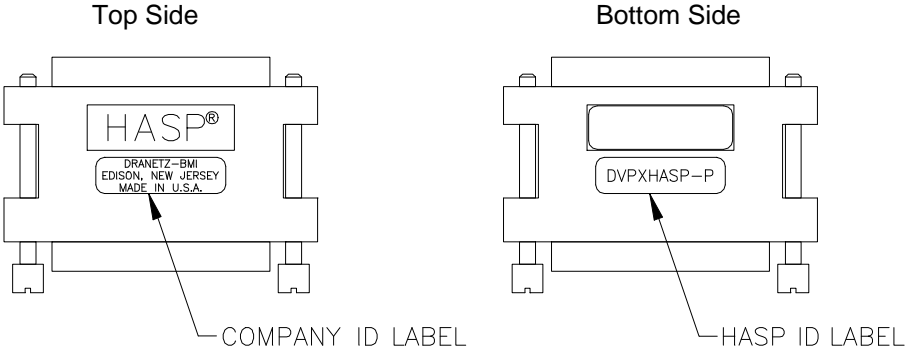

Continued on next page

Installation procedure (continued)

The table below shows the HASP ID labels that go with the corresponding Dranetz-BMI product.

Supports the following Dranetz-BMI products	ID Label	
	HASP for USB Port	HASP for Printer or Parallel Port
PP4300 PQLite; 808; Multi-DAQ	DV4300HASP	DV4300HASP-P
PX5; PX5-400; PowerVisa; PowerGuia 440S	DVPXHASP	DVPXHASP-P
All Dranetz-BMI products including PX5, PowerGuia, and PowerVisa with MATH, PQDIF driver	DVPXALLHASP	DVPXALLHASP-P
PX5; PowerGuia; PowerVisa; 658; PP1; 4300	DVDRANHASP	DVDRANHASP-P

STEP 3: Start DranView®. Double-click the DranView® icon at any time to start DranView®.

For additional information, refer to the on-line Help documentation included in the DranView® application or the DranView® User’s Guide. The Getting Started section of the User’s Guide provides a complete description of how to use DranView®.

NOTE: If the HASP is not inserted (or is not detected), DranView® will operate in DEMO mode only.

Customer service and support

If any item is missing, or for installation or operating assistance with the DranView® software package, please contact the Dranetz-BMI Customer Support at (732) 287-3680 or 1-800-372-6832.

As part of our continuing quality development effort, and in the event of finding serious bugs, Dranetz-BMI may occasionally post a self-installing upgrade patch which users can download for free. The patch may be found at the Dranetz-BMI website www.dranetz-bmi.com under “Software Packages and Updates”. The upgrades are available to users who are registered owners of DranView®. They will not work for demo or unregistered installations of DranView®.

A P P E N D I X A



Optional Accessories

Overview

Introduction

This appendix lists the optional accessories for PowerVisa. It covers the hardware accessories available for use with the PowerVisa and the Dranetz-BMI software applications used to download and view event data in a computer.

Topic	See Page
Hardware Accessories List & Descriptions	A-2
Software Accessories List	A-8

Ordering information

To order accessories, contact Dranetz-BMI Customer Service Department at:

Dranetz-BMI	Tel: (732) 287-3680
1000 New Durham Road	Tel: 1-800-372-6832
Edison, NJ 08818-4019 USA	FAX: (732) 248-1834
Attention: Customer Service	www.dranetz-bmi.com

Hardware Accessories List & Descriptions

Hardware Accessories List

Accessory	Part Number
Current Probes	
Current Probe Assembly, 10 to 500 A RMS	TR-2500
Current Probe, 10 to 500 A	TR-2500A
Current Probe Assembly, 0.1 to 10 A RMS	TR-2510
Current Probe, 1 to 10 A	TR-2510A
Current Probe Assembly, 300 to 3000 A RMS	TR-2520
Current Probe, 10 to 3000 A	TR-2520A
Current Probe Assembly, 1 to 30 A RMS	TR-2021
Current Probe Assembly, 1 to 300 A RMS	TR-2019B
Current Probe Assembly, 10 to 1000 A RMS	TR-2022
Current Probe Assembly, 10 to 3000 A RMS	TR-2023
LEMFLEX Probes	
LEMFLEX Current Probe, 30A/300A/3000A, 24"	RR-3035A-24
LEMFLEX Current Probe, 30A/300A/3000A, 36"	RR-3035A-36
LEMFLEX Current Probe, 30A/300A/3000A, 48"	RR-3035A-48
LEMFLEX Current Probe, 60A/600A/6000A, 24"	RR-6035A-24
LEMFLEX Current Probe, 60A/600A/6000A, 36"	RR-6035A-36
LEMFLEX Current Probe, 60A/600A/6000A, 48"	RR-6035A-48
Battery Powered DRANFLEX Probes	
DRANFLEX Current Probe, 300A/3000A, 24"	DRANFLEX4300-3K24
DRANFLEX Current Probe, 300A/3000A, 36"	DRANFLEX4300-3K36
DRANFLEX Current Probe, 300A/3000A, 48"	DRANFLEX4300-3K48
DRANFLEX Current Probe, 600A/6000A, 24"	DRANFLEX4300-6K24
DRANFLEX Current Probe, 600A/6000A, 36"	DRANFLEX4300-6K36
DRANFLEX Current Probe, 600A/6000A, 48"	DRANFLEX4300-6K48
DRANFLEX Probes for use with External Battery Charger (P/N DF-PSP)	
DRANFLEX Current Probe, 300A/3000A, 24"	DRANFLEXPP1-3K24
DRANFLEX Current Probe, 300A/3000A, 36"	DRANFLEXPP1-3K36
DRANFLEX Current Probe, 300A/3000A, 48"	DRANFLEXPP1-3K48
DRANFLEX Current Probe, 600A/6000A, 24"	DRANFLEXPP1-6K24
DRANFLEX Current Probe, 600A/6000A, 36"	DRANFLEXPP1-6K36
DRANFLEX Current Probe, 600A/6000A, 48"	DRANFLEXPP1-6K48

Continued on next page

**Hardware
Accessories List
(continued)**

Accessory	Part Number
<u>AC/DC Current Probes</u>	
AC/DC Current Probe, 150A, Without AC Adapter	PR150/SP1
AC/DC Current Probe, 150A, Battery Powered	PR150/SP2
AC/DC Current Probe, 1500A, Without AC Adapter	PR1500/SP7
AC/DC Current Probe, 1500A, Battery Powered	PR1500/SP8
Current Probe Adapter Cables	
Adapter Cable, 658 Current Probe to 4300	CA-4300
Adapter Cable, 4300/LEMFLEX	CA4300LEM
AC Adapter with 4 Phase Adapter Cable for LEMFLEX Probes	RR/PS/4P
Probe Adapter Cable for LEMFLEX , Hypertronics to Redel	TRTOREDEL
<u>For Use with Current Probes PR150/SP1 and PR150/SP2</u>	
AC Adapter, 9V, US	T402-P5P-ND
AC Adapter, 9V, EURO	T408-P5P-ND
Voltage Probes	
Fuse Voltage Adapter, for single phase connection	FVA-1
Fuse Voltage Adapter, for three phase connection	FVA-4
Single Phase Measurement Cord, 115V, US	SPMEASCORD-US
Single Phase Measurement Cord, 250V, Europe	SPMEASCORD-EURO
Single Phase Measurement Cord, 250V, UK	SPMEASCORD-UK
Single Phase Measurement Cord, 250V, Australia	SPMEASCORD-AUST
Data Card	
Compact Flash Data Card (32 MB)	32MDATA
Compact Flash Data Card (64 MB)	64MDATA
Compact Flash Data Card (128 MB)	128MDATA
Compact Flash Card Reader, Parallel	FLASHREADER-P
Compact Flash Card Reader, USB	FLASHREADER-USB
Isolated Communications Module Assembly	
Fiber Optic Cable	900406
<u>External Communication Adapter</u>	
RS232 - Fiber Optic Adapter	COMM-RS232
LAN - Fiber Optic Adapter	COMM-OEA
USB - Fiber Optic Adapter	COMM-OUA

Continued on next page

**Hardware
Accessories List
(continued)**

Accessory	Part Number
Miscellaneous Hardware	
Weather Resistant Enclosure	ENCL-HH
Soft Carrying Case	SCC-4300
Reusable Shipping Container	RSC-4300
Battery Pack, 7.2V, 2.7Ah	BP-PX5
External Battery Charger/UPS	XBC-PX5
External Battery Charger with LEMFLEX Adapter Cables	LF-PSP
External Battery Charger with DRANFLEX Probe Power Adapter	DF-PSP
Isolated Current Transformer 0.1A to 5A	ISO-65X-5
Dranetz-BMI Reference Publications	
Field Handbook for Electrical Energy Management	HB114415
Field Handbook for Power Quality Analysis	HB114414-S

Current probes Several Dranetz-BMI current probes can be used with PowerVisa: models TR2500/A, TR2510/A, TR2520/A, TR2019B, TR2021, TR2022, TR2023. The PowerVisa supports both LEMFLEX and DRANFLEX current probes. Typical current probes are illustrated in Chapter 2.

TR2500, TR2510, TR2520 (TR2500A, TR2510A, TR2520A): These models will measure rms currents from 10 to 500 A, 0.1 to 500 A, 300 to 3000 A, respectively. They plug directly into any of the current inputs on the rear panel. These probes are not recommended for measuring medium or high frequency transients.

TR2021, TR2019B, TR2022, TR2023: These four probes are made for the Dranetz-BMI model 658 but can be used with PowerVisa by using an adapter cable (part number CA-4300). They can measure rms currents in ranges of 1 to 30 A, 1 to 300 A, 10 to 1000 A, and 10 to 3000 A, respectively, and are needed to accurately measure medium and high frequency transients.

LEMFLEX Current Probes: LEMFLEX optional current probes allow current measurements in the range of 5 to 3000 A full scale, or 10 to 6000 A full scale. LEMFLEX probes are available in three sizes: 24" probe length - conductor(s) up to 8" diameter; 36" probe length - conductor(s) up to 11" diameter; 48" probe length - conductor(s) up to 17" diameter.

DRANFLEX Current Probes: DRANFLEX optional current probes allow current measurements in the range of 5 to 3000 A full scale, or 10 to 6000 A full scale. DRANFLEX probes are available in three sizes: 24" probe length - conductor(s) up to 8" diameter; 36" probe length - conductor(s) up to 11" diameter; 48" probe length - conductor(s) up to 17" diameter.

DRANFLEX4300 probes are battery powered only, supplied with a standard 9V alkaline battery.

DRANFLEXPP1 probes require the use of the External Battery Charger with DRANFLEX Probe Power Adapter (P/N DF-PSP) to connect with PowerVisa. Contact Dranetz-BMI Customer Service Department for more information on DRANFLEX Probe Accessories and refer to Information Sheet 899121.

Voltage probes Fuse Voltage Adapter: Two accessory kits available: FVA-1 and FVA-4. FVA-1 is used for a single voltage measurement input. It contains one fused voltage adapter and one measurement connecting cable (Red) 50 cm in length. FVA-4 is used for a three phase and neutral voltage measurement inputs. It contains four voltage adapters and four measurement connecting cables 50 cm in length (one Red, one Yellow, one Blue, one Grey).

Single Phase Measurement Cord: Allows measurement of a single phase circuit using a standard AC outlet 115V for US and 250V for European, UK, and Australian countries.

Continued on next page

Data card Compact Flash Data Card: The PowerVisa supports the use of Compact Flash cards in its native format, without the need for PC card adapter. Compact Flash cards are available in three sizes: 32MB, 64MB, and 128MB.

Compact Flash Card Readers: Two types of card readers are available for easy data manipulation and data transfer from the Compact Flash card to the computer: via USB port (FLASHREADER-USB) or via parallel port (FLASHREADER-P).

Communication interface Allows connection to the PowerVisa mainframe via the Isolated Communications Module Assembly.

Fiber Optic Cable: Connects the communication adapter described below to the PowerVisa optical serial data port connector.

External Communication Adapter: Consists of an enclosure containing the connector/pcb assembly, with a cable connected to either of the following connector:

- RS232 - Fiber Optic Adapter
- USB - Fiber Optic Adapter
- LAN - Fiber Optic Adapter

Miscellaneous hardware Weather Resistant Enclosure: This weatherproof enclosure is designed to keep the PowerVisa and its cable connections in place. It is made of fiber glass and is intended for indoor and outdoor use. This enclosure is sturdy, lightweight, corrosion-resistant. It is able to withstand windblown dust, rain, splashing water, and ice formation.

Soft Carrying Case: Heavy-duty, padded, nylon carrying case. Includes pockets for cable set, current probes, and other accessories.

Reusable Shipping Container: Lockable, high-impact plastic case with foam insulation for protecting the instrument during shipping.

Battery Pack: NiMH (Nickel Metal Hydride) battery cells are used in PowerVisa. See Appendix C Battery Specifications and Replacement Procedure.

External Battery Charger: The XBC-PX5 charges a battery pack while the instrument is in use and may be used to power specified Dranetz-BMI probes.

Isolated Current Transformer: Allows the connection of other industry-standard 0.1A to 5A output current transformers to Dranetz-BMI equipment.

Continued on next page

**Dranetz-BMI
reference
publications**

Field Handbook for Electrical Energy Management: This reference handbook provides a comprehensive guide for information related to conducting a thorough energy audit, power distribution analysis, and methods of remedying inefficiencies of energy management.

Field Handbook for Power Quality Analysis: This handbook is divided into six sections containing step-by-step instructions for discovering and solving complex power quality problems. Example waveforms and case studies are included.

Software Accessories List

Accessories List

Accessory	Part Number
NodeLink	
NodeLink® V2.5 or higher with download, setups and meters	NODELINK
DranView	
DranView® V5.8 or higher with PowerVisa driver [5-User Package]	DV5DRANTOPX 5PK-DV5DRANTOPX
DranView Math Driver [5-User Package]	DVMATHDRIVER 5PK-DVMATH
<u>DranView® Software Package with HASP for USB Port:</u> supports PX5, PX5-400, PowerGuia, and PowerVisa [5-User Package]	DVPXHASP 5PK-DVPXHASP
supports all Dranetz-BMI products including PX5, PowerGuia and PowerVisa with Math and PQDIF driver [5-User Package]	DVPXALLHASP 5PK-DVPXALLHASP
supports PX5, PowerGuia, PowerVisa, 658, PP1 and PP4300 [5-User Package]	DVDRANHASP 5PK-DVDRANHASP
<u>DranView® Software Package with HASP for Parallel Port:</u> supports PX5, PX5-400, PowerVisa [5-User Package]	DVPXHASP-P 5PK-DVPXHASP-P
supports all Dranetz-BMI products including PX5, PowerGuia and PowerVisa with Math and PQDIF driver [5-User Package]	DVPXALLHASP-P 5PK-DVPXALLHASP-P
supports PX5, PowerGuia, PowerVisa, 658, PP1 and PP4300 [5-User Package]	DVDRANHASP-P 5PK-DVDRANHASP-P
Replacement Hasp for PX5 and PowerVisa0	HASP-DVPX

**NodeLink® and
DranView®
applications**

NodeLink® is an easy-to-use Windows® application that allows users to transfer, download, or view real time data from PowerVisa to a computer. Users can also transfer setups from a computer to the PowerVisa using NodeLink®. PowerVisa firmware requires NodeLink® V2.5 or higher with download, setups, and meters. Users are strongly advised to always keep their PowerVisa program current with the latest firmware version released by Dranetz-BMI. Log on to the Dranetz-BMI website, www.dranetz-bmi.com, to download the latest PowerVisa firmware upgrade version.

DranView® is a Windows®-based program that is used to archive, view and analyze event data downloaded in the computer. PowerVisa firmware requires DranView® V5.8 or higher with PowerVisa driver.

DranView® is available in soft key version (without HASP) and in hard key version (with HASP). DranView® soft key version does not require a hardware lock or HASP in order to work properly in a computer. The DranView® hard key version can be installed in multiple computers, but can only be used in a computer where a HASP driver is properly installed. A HASP is available for installation to either the USB port or the Printer/Parallel port.

For more information on the NodeLink® and DranView® product applications, refer to Chapter 9 Downloading Events.



A P P E N D I X B



Technical Specifications

Overview

In this appendix The following specifications are covered in this appendix.

Topic	See Page
General	B-2
Interfaces	B-3
Measured Parameters	B-4
Computed Parameters	B-5
Parameter Settings in Each Monitoring Mode	B-9
TR2500 Current Probe	B-11
TR2510 Current Probe	B-12

General

Dimensions Size: 12" Width x 2.5" Height x 8" Depth (30 x 6.4 x 20.3 cm)

Weight: 3.8 pounds

Environmental Operating: 0 to 50 °C (32 to 122 °F)

Storage: -20 to 55 °C (4 to 131 °F)

Humidity: 0 to 95% non-condensing; indoor use

Altitude: 2000 m (6560 ft) maximum

System Time Clock Crystal controlled; 1 second resolution
Event time clock displays to 1 msec resolution
Time displayed in analog or digital (12 or 24 hour) format
Accurate to 60 seconds per month

Compact Flash Data Card Sizes range from 32MB to 128MB

Power Requirements Use ONLY the external power supply provided with the unit for operation and battery charging. Use of any other power supply is not recommended.

Voltage: 90-264V AC, 45-66 Hz

Consumption: 20 watts maximum

Field replaceable batteries: More than 2 hours run-time (3 hours typical) when fully charged.

Input resistance Voltage input: 16 MΩ Line to Line

Current input: 400 kΩ

Interfaces

Installation Categories

Mains supply: Installation Category II, Pollution Degree 2

Measurement inputs: Installation Category III, Pollution Degree 2

Display

Type: 1/4 VGA color graphic, touch screen Liquid Crystal Display (LCD) with compact fluorescent (CCFL) backlighting. Programmable backlight time-out to reduce power consumption. Reactivates with touch.

Resolution: 360 x 240 dot matrix

Size: 3.75 x 4.75 inches

Alarm

Audible alarm of short (approximately 0.1 second) or long (approximately 1 second) duration to call attention to an error condition or event trigger, respectively.

Communication

Connect to the PowerVisa mainframe using either of the following external interface:

- RS232 - Fiber Optic adapter
 - USB - Fiber Optic adapter
 - LAN - Fiber Optic adapter
 - Modem
-

Measured Parameters

Voltage

Type: 4 full differential, DC coupled

Channels A, B, C, D Input Range: 10 - 600 Vrms

Input impedance: 16 M Ω , minimum, Input to Input

RMS Accuracy: $\pm 0.1\%$ of Reading, $\pm 0.05\%$ Full Scale, over 7KHz bandwidth
(1 second rms readings)

CMRR: -80 db typical

Current

Type: 4 full differential, DC coupled.

Channels A, B, C, D Input Range: 10 - 200% of Rated Probe Input (Dranetz-BMI probes)

RMS Accuracy:
 $\pm 0.1\%$ of Reading $\pm 0.05\%$ Full Scale plus Probe Accuracy, 3KHz bandwidth (1 second rms readings)

Phase

Each voltage/current pair (i.e. Channel A voltage, Channel A current) are sampled simultaneously to preserve phase relationship.

Frequency

Two ranges, user selectable.

For PowerVisa:

- 30 - 70 Hz default, with up to 25% Vthd
- 15 - 30 Hz

Accuracy: $\pm 0.2\%$ of reading

Environmental

All specifications are met over the operating range with influence factors as per IEC 61000-4-30 Class A.

Computed Parameters

Single Channel Parameters

The computations below apply to single channel parameters.
Note that $\theta_V = \text{Phase Angle of Voltage}$, while $\theta_I = \text{Phase Angle of Current}$.

True Average Power

Average of the instantaneous power samples taken as the product of voltage and current samples. Includes sign to indicate direction of power flow: positive (+) from source to load, negative (-) from load to source.

$$WATT = \frac{1}{N} \sum_{n=1}^N V_n I_n$$

where N = number of samples

$V_n = \text{Voltage at sample } n$

$I_n = \text{Current at sample } n$

Apparent Power

Unsigned value calculated using the product of the rms values of the voltage and current.

$$VA = V_{RMS} I_{RMS}$$

Fundamental Apparent Power

Unsigned value calculated using the product of the fundamental rms values of the voltage and current.

$$VA_{fund} = V_{fund} I_{fund}$$

Fundamental Power

Signed value calculated using the product of the fundamental apparent power and the cosine of the phase angle between the fundamental frequency components of voltage with respect to current ($\theta = \theta_V - \theta_I$).

$$WATT_{fund} = VA_{fund} \cos \mathbf{q}$$

Volt Ampere Reactive

Signed value calculated using the product of the fundamental apparent power and the sine of the phase angle between the fundamental frequency components of voltage with respect to current ($\theta = \theta_V - \theta_I$).

$$VAR_{fund} = VA_{fund} \sin \mathbf{q}$$

Continued on next page

True Power Factor

Calculated using the True Average Power divided by the Apparent Power. See Note below for sign information.

$$TPF = \left| \frac{WATT}{VA} \right|$$

Displacement Power Factor

Calculated using cosine of the phase angle between the fundamental frequency components of voltage with respect to current ($\theta = \theta_V - \theta_I$). See Note below for sign information.

$$DPF = |\cos \theta|$$

NOTE

The sign is the exclusive OR of the sign of the Watts and Vars. Note that for Power Factor, the words “Lead” and “Lag” are definitive. As far as the signs go, it is assumed that Lag (inductive) is plus and Lead (capacitive) is minus when energy is delivered to the load.

Quad	2		Quad	1
PF Lead	-		PF Lag	+
Watts	-		Watts	+
Vars	+		Vars	+
Quad	3		Quad	4
PF Lag	+		PF Lead	-
Watts	-		Watts	+
Vars	-		Vars	-

In the code, this is implemented as:

Signum Watts: $\cos \theta$

Signum Vars: $\sin \theta$

Signum PF: (Signum Watts) * (Signum Vars)

where signum denotes the positive or negative sign.

Source: The diagram above matches *Figure 9-26 Relationships Between Watts, Vars, and Volt-Amperes* found on page 228 of the Handbook for Electricity Metering, Ninth Edition, ©1992, Edison Electric Institute, Washington, D.C., USA.

Continued on next page

Totals

The computations below apply to three phase wye configuration.

Totals for split phase can be determined by eliminating phase C (i.e. split phase
 $WATT_{Tot} = WATT_A + WATT_B$)

Power Total

$$WATT_{Tot} = WATT_A + WATT_B + WATT_C$$

Fundamental Power Total

$$WATT_{Tot\ fund} = WATT_{A\ fund} + WATT_{B\ fund} + WATT_{C\ fund}$$

Fundamental Reactive Power Total

$$VAR_{Tot\ fund} = VAR_{A\ fund} + VAR_{B\ fund} + VAR_{C\ fund}$$

Apparent Power, Arithmetic Total

$$VA_{Arithmetic\ Tot} = VA_A + VA_B + VA_C$$

Apparent Power, Vector Total

$$VA_{Vector\ Tot} = \sqrt{WATT_{Tot}^2 + VAR_{Tot\ fund}^2}$$

Fundamental Apparent Power, Arithmetic Total

$$VA_{Arithmetic\ Tot\ fund} = VA_{A\ fund} + VA_{B\ fund} + VA_{C\ fund}$$

Fundamental Apparent Power, Vector Total

$$VA_{Vector\ Tot\ fund} = \sqrt{WATT_{Tot\ fund}^2 + VAR_{Tot\ fund}^2}$$

Continued on next page

True Power Factor, Arithmetic Total See Note on page B-7 for sign information.

$$TPF_{Arithmetic\ Tot} = \left| \frac{WATT_{Tot}}{VA_{Arithmetic\ Tot}} \right|$$

True Power Factor, Vector Total See Note on page B-7 for sign information.

$$TPF_{Vector-Tot} = \left| \frac{WATT_{Tot}}{VA_{Vector\ Tot}} \right|$$

Displacement Power Factor, Arithmetic Total See Note on page B-7 for sign information.

$$DPF_{Arithmetic\ Tot} = \left| \frac{WATT_{Tot}}{VA_{Arithmetic\ Tot\ fund}} \right|$$

Displacement Power Factor, Vector Total See Note on page B-7 for sign information.

$$DPF_{Vector\ Tot} = \left| \frac{WATT_{Tot\ fund}}{VA_{Vector\ Tot\ fund}} \right|$$

Parameter Settings in Each Monitoring Mode

Setup parameters

The following table lists the default settings for the threshold parameters in each monitoring mode.

Parameters	Standard Power Quality	Long-term Timed Recording	Continuous Data Logging	EN50160
RMS Variation				
High Limit	110%	Off	Off	110%
Low Limit	90%	Off	Off	90%
Very Low Limit	10%	Off	Off	1%
RMS Pre-trigger (cycles)	6	0	1	6
RMS In-Out Post-trigger (cycles)	6	10 (50 Hz); 12 (60 Hz)	2	6
RMS Out-In Post-trigger (cycles)	6	10 (50 Hz); 12 (60 Hz)	2	6
Waveform Capture Pre-trigger (cycles)	2	0	1	2
Waveform Capture Post-trigger (cycles)	2	10 (50 Hz); 12 (60 Hz)	2	2
Transients				
Absolute Instantaneous Peak	170%	Off	Off	170%
Cycle-by-cycle Waveshape Magnitude	10%	Off	Off	10%
Cycle-by-cycle Waveshape Duration (% of cycle)	10%	Off	Off	10%
Waveform Duration	7%	Off	Off	7%

Continued on next page

**Setup
parameters
(continued)**

The following table lists the default settings for the threshold parameters in each monitoring mode.

Parameters	Standard Power Quality	Long-term Timed Recording	Continuous Data Logging	EN50160
Waveform Capture Trigger Response				
When Volts go out, record:	All Active Channels	Off	Off	All Active Channels
When Amps go out, record:	Fault Amps Channels	Off	Off	Fault Amps Channels
Journal Intervals				
Volts	10 minutes	10 minutes	1 second	10 minutes
Amps	10 minutes	10 minutes	1 second	10 minutes
Power	10 minutes	10 minutes	1 second	10 minutes
Demand	15 minutes	15 minutes	Off	15 minutes
Energy	10 minutes	10 minutes	Off	10 minutes
Harmonics	10 minutes	10 minutes	Off	10 minutes
Flicker (Pst)	10 minutes	10 minutes	Off	10 minutes
Flicker (Plt)	2 hours	2 hours	Off	2 hours
Characterizer Mode	IEEE 1159	IEEE 1159	None	IEC 61000-4-30

**Numbers are in percent of nominal unless otherwise specified.*

TR2500 Current Probe

- Guidelines** To achieve the rated accuracies, follow these guidelines:
- The conductor must be at a right angle to the probe.
 - The conductor must be centered in the probe core.
 - The jaw contact surfaces must be clean and properly aligned.
-

- Specifications**
- Range: 1 to 500 Arms
- Accuracy:
48 to 400 Hz: $\pm 1.5\%$ reading $\pm 0.6A$
400 to 3000 Hz: $\pm 3\%$ reading $\pm 0.8A$
- Working voltage: 600 V max.
- Frequency range: 48 to 3000 Hz
- Output signal: 3 mV/A
- Maximum conductor size: 1.18" (30 mm)
- Maximum bus bar size: 2.5 x 0.20" (63 x 5 mm)
- Phase shift (45 to 1000 Hz): Less than 4°
- Operating temperature: 14 to 122 °F (-10 to 50 °C)
- Storage temperature: -40 to 158 °F (-40 to 70 °C)
- Dimensions: 2.60 x 7.68 x 1.34" (66 x 195 x 34 mm)
- Weight: 14.82 oz. (420 g)
-

NOTE Current probe TR2500 can be used interchangeably with TR2500A.

TR2510 Current Probe

- Guidelines** To achieve the rated accuracies, follow these guidelines:
- The conductor must be at a right angle to the probe.
 - The conductor must be centered in the probe core.
 - The jaw contact surfaces must be clean and properly aligned.

-
- Specifications**
- Range: 0.1 to 10 Arms
- Accuracy (at 60 Hz): 0.1 to 10A, $\pm 1\%$ reading $\pm 0.01A$
- Working voltage: 600 V max.
- Frequency range: 40 to 3000 Hz
- Output signal: 150 mV/A
- Maximum conductor size: 0.78" (20 mm)
- Phase shift (at 60 Hz):
1 to 5A less than 1°
5 to 10A less than 1.5°
- Operating temperature: 14 to 131 °F (-10 to 55 °C)
- Storage temperature: -40 to 158 °F (-40 to 70 °C)
- Dimensions: 5.47 x 2.00 x 1.18" (139 x 51 x 30 mm)
- Weight: 6.5 oz. (180 g)

NOTE Current probe TR2510 can be used interchangeably with TR2510A.

A P P E N D I X C



Battery Specifications and Replacement Procedure

Overview

Introduction The internal battery pack used in PowerVisa functions as the primary power source and UPS. Always charge the battery fully before using the unit. PowerVisa will fully charge its internal battery in six (6) hours.

PowerVisa uses a non-volatile flash memory for backup that is not operator replaceable. The flash memory will store data temporarily.

In this appendix The following topics are covered in this appendix.

Topic	See Page
Battery Specifications	C-2
Battery Pack Safety Precautions	C-3
Battery Pack Replacement	C-4

Battery Specifications

Battery pack Location: Battery compartment on the rear of the unit.

Number of batteries in pack: 6

Type: Sealed, rechargeable NiMH (Nickel Metal Hydride) cells

Voltage: 7.2 V dc

Capacity: 2.7 Ah

Length of operation: More than two (2) hours when fully charged and with backlight on. When backlight is turned off, the unit can run continuously for more than three (3) hours.

Suggested replacement interval: Two years

Part Number: BP-PX5

 NOTE: The length of time that PowerVisa can operate on the battery pack degrades over the life of the batteries and the number of charge/discharge cycles.

Memory backup PowerVisa uses a non-volatile flash memory for data storage. Data will not be lost if the battery pack is removed.

Battery Pack Safety Precautions

WARNING DO NOT intentionally short circuit the battery pack. The batteries are capable of providing hazardous output currents if short circuited. The PowerVisa is equipped with an internal battery charger circuit. Do not attempt to charge the batteries with an external charger other than the Dranetz-BMI battery charger, since improper charging could cause battery explosion.

ADVERTENCIA NO ponga intencionalmente la batería en cortocircuito. Las baterías son capaces de proporcionar corrientes de salida peligrosas si están en cortocircuito. La PowerVisa está equipada con un circuito interno cargador de baterías. No intente cargar las baterías con un cargador externo que no sea el cargador de baterías Dranetz-BMI, puesto que la carga indebida podría hacer que explote la batería.

AVERTISSEMENT NE PAS court-circuiter délibérément le bloc-batterie. Lors d'un court-circuit, les batteries risquent d'émettre des courants effectifs dangereux. PowerVisa possède un circuit de chargeur de batterie intégré. Ne pas tenter de charger les batteries au moyen d'un chargeur externe autre que le chargeur de batterie Dranetz-BMI, car un rechargement fautif pourrait entraîner l'explosion de la batterie.

WARNUNG Die Batterien dürfen NICHT kurzgeschlossen werden. Im Falle eines Kurzschlusses können die Batterien lebensgefährliche Ausgangsströme leiten. PowerVisa ist mit einem internen Batterieladegerät ausgestattet. Die Batterien sollten nur mit dem Ladegerät von Dranetz-BMI geladen werden. Die Verwendung eines externen Ladegeräts kann zu einer Explosion der Batterien führen.

Battery safety precautions

- Observe the following precautions when inspecting or replacing the battery pack:
- Do not attempt to replace individual batteries of the pack or substitute other battery types.
 - Do not dispose of battery in fire.
 - Dispose of a used battery promptly in accordance with local Environmental Protection Agency (EPA) regulations.
 - Visually inspect the battery pack for corrosion.

The batteries have a safety pressure vent to prevent excessive gas build-up and corrosion indicates that venting has occurred. Possible causes of venting are: a defective charger, excessive temperature, excessive discharge rate, or a defective cell.

If corrosion is excessive, the battery pack may require replacement (contact Dranetz-BMI Customer Service Department).

Battery Pack Replacement

Introduction The PowerVisa contains an easily replaceable internal battery pack. See Appendix D for ordering information.

WARNING Replace with Dranetz-BMI NiMH battery pack BP-PX5 only.

ADVERTENCIA Reemplace con batería Dranetz-BMI NiMH BP-PX5 solamente.

AVERTISSEMENT Remplacer par la batterie Dranetz-BMI NiMH BP-PX5 exclusivement.

WARNUNG Nur mit Dranetz-BMI NiMH BP-PX5 Batteriesatz auswechseln.

NOTE During normal operation, the battery pack will be slightly warm to the touch.

Procedure Follow these steps to replace the battery pack.

Step	Action
1	Press the PowerVisa power button to off.
2	Turn off power to the circuit being measured.
3	Disconnect voltage and current probes from the circuit and the PowerVisa is rear panel.
4	On the bottom of the PowerVisa, push the tab to release the battery cover. Refer to the diagram shown on page C-5.
5	Remove the cover.
6	Pull up on removal strap and remove battery pack.
7	Insert the new pack into the compartment making sure to observe polarity markings.
8	Replace the cover and press down until it latches closed.
9	Discard the old battery pack in accordance with Environmental Protection Agency (EPA) regulations.
10	Press the PowerVisa power button to on.

Continued on next page

**Battery removal
diagram**

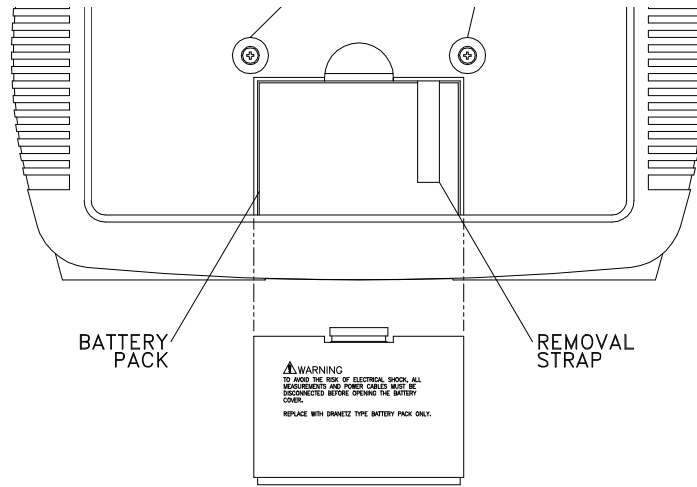



A P P E N D I X D



User Replaceable Parts List

Introduction The following parts are easily replaced by the operator and do not require special tools or access to the interior of the unit.

To order parts Call Dranetz-BMI Customer Service at (732) 287-3680 or 1-800-372-6832 to order any of the following parts.

Parts List

Part Description	Part Number
AC Adapter/Battery Charger	XBC-PX5
Battery Door	116037-G1
Battery Pack	BP-PX5
Rubber Skin for PowerVisa	116035-G3
Voltage Cable Assembly, 4 Pair w/ Alligator Probes (See below for separate parts)	116042-G3

Measurement cable set, parts list

Part Description	Quantity	Part Number
Measurement Channel Cable Assembly	4	114013-G1
Alligator Clip, 4MM Plug-on, Red	4	900371
Alligator Clip, 4MM Plug-on, Black	4	900372
1000V Cable, Red	1	900366
Yellow Cable/Plug	1	900367
6FT Cable/Plug Blue	1	900368
6FT Cable/Plug Gray	1	900369
6FT Cable/Plug White	1	900370
Carry Strap	1	116040-G1
Cable Pouch	1	116043-G1



A P P E N D I X E



Common Circuit Connections

Overview

Who should read this section

If you are making power measurements, follow these diagrams so that your ABC values are calculated correctly.

WARNING

Death, serious injury, or fire hazard could result from improper connection of this instrument. Read and understand this manual before connecting this instrument. Follow all installation and operating instructions while using this instrument.

Connection of this instrument must be performed in compliance with the National Electrical Code (ANSI/NFPA 70-2005) and any additional safety requirements applicable to your installation.

Installation, operation, and maintenance of this instrument must be performed by qualified personnel only. The National Electrical Code defines a qualified person as “one who has the skills and knowledge related to the construction and operation of the electrical equipment and installations, and who has received safety training on the hazards involved.”

Qualified personnel who work on or near exposed energized electrical conductors must follow applicable safety related work practices and procedures including appropriate personal protective equipment in compliance with the Standard for Electrical Safety Requirements for Employee Workplaces (ANSI/NFPA 70E-2000) of USA and any additional workplace safety requirements applicable to your installation.

ADVERTENCIA

Una conexión incorrecta de este instrumento puede producir la muerte, lesiones graves y riesgo de incendio. Lea y entienda este manual antes de conectar. Observe todas las instrucciones de instalación y operación durante el uso de este instrumento.

La conexión de este instrumento debe ser hecha de acuerdo con las normas del Código Eléctrico Nacional (ANSI/NFPA 70-2005) de EE. UU., además de cualquier otra norma de seguridad correspondiente a su establecimiento.

La instalación, operación y mantenimiento de este instrumento debe ser realizada por personal calificado solamente. El Código Eléctrico Nacional define a una persona calificada como "una que esté familiarizada con la construcción y operación del equipo y con los riesgos involucrados."

AVERTISSEMENT Si l'instrument est mal connecté, la mort, des blessures graves, ou un danger d'incendie peuvent s'en suivre. Lisez attentivement ce manuel avant de connecter l'instrument. Lorsque vous utilisez l'instrument, suivez toutes les instructions d'installation et de service.

Cet instrument doit être connecté conformément au National Electrical Code (ANSI/NFPA 70-2005) des Etats-Unis et à toutes les exigences de sécurité applicables à votre installation.

Cet instrument doit être installé, utilisé et entretenu uniquement par un personnel qualifié. Selon le National Electrical Code, une personne est qualifiée si "elle connaît bien la construction et l'utilisation de l'équipement, ainsi que les dangers que cela implique".

WARNUNG Der falsche Anschluß dieses Gerätes kann Tod, schwere Verletzungen oder Feuer verursachen. Bevor Sie dieses Instrument anschließen, müssen Sie die Anleitung lesen und verstanden haben. Bei der Verwendung dieses Instruments müssen alle Installation- und Betriebsanweisungen beachtet werden.

Der Anschluß dieses Instruments muß in Übereinstimmung mit den nationalen Bestimmungen für Elektrizität (ANSI/NFPA 70-2005) der Vereinigten Staaten, sowie allen weiteren, in Ihrem Fall anwendbaren Sicherheitsbestimmungen, vorgenommen werden.

Installation, Betrieb und Wartung dieses Instruments dürfen nur von Fachpersonal durchgeführt werden. In dem nationalen Bestimmungen für Elektrizität wird ein Fachmann als eine Person bezeichnet, welche "mit der Bauweise und dem Betrieb des Gerätes sowie den dazugehörigen Gefahren vertraut ist."

Continued on next page

WARNING To avoid the risk of electric shock or burns, always connect the safety (or earth) ground before making any other connections.

WARNING To reduce the risk of fire, electrical shock, or physical injury it is strongly recommended to fuse the voltage measurement inputs. Fuses must be located as close to the load as possible to maximize protection.

WARNING For continued protection against risk of fire or shock hazard replace only with same type and rating of recommended fuse. Use only fast blow type fuse which is rated 600V. Recommended fuse type is Littelfuse, part number KLKD.300 rated 600V AC/DC, 0.3A fast blow.

WARNING Do not replace fuse again if failure is repeated. Repeated failure indicates a defective condition that will not clear with replacement of the fuse. Refer condition to a qualified technician.

Safety precautions

The following safety precautions must be followed whenever any type of voltage or current connection is being made to the PowerVisa.

- Wear proper Personal Protective Equipment, including safety glasses and insulated gloves when making connections to power circuits.
 - Hands, shoes and floor must be dry when making any connection to a power line.
 - Before each use, inspect all cables for breaks or cracks in the insulation. Replace immediately if defective.
 - Set the PowerVisa power switch to Off.
 - Before connecting to electric circuits to be monitored, open their related circuit breakers or disconnects. DO NOT install any connection of the PowerVisa to live power lines.
 - Connections must be made to the PowerVisa first, then connect to the circuit to be monitored.
-

Continued on next page

Voltage and current connections

This section contains diagrams of both voltage and current probe connections that are required when power measurements are to be made.

Voltage: Voltage probes are connected to the individual source or load line and are referenced to the return (common) line voltage probe connection for greatest accuracy.

Current: Current probes are connected to each line and positioned to measure currents with reference to the voltage probe. Incorrectly positioned current probes may produce erroneous power measurement. Current probes are always oriented with the arrow pointing to the load.

Phasor diagrams

Correct phasor diagrams (for resistive loads) are shown for each connection.

In this appendix The following connections are shown in this appendix.

Topic	See Page
Verifying Voltage and Current Connections	E-5
Single Phase	E-7
Split Phase	E-8
3 Phase, Four Wire Wye	E-9
3 Phase (Floating or Grounded) Delta	E-10
3 Phase 2-Watt Delta	E-11
Generic Circuit	E-12
2 1/2 Element Without Voltage Channel B	E-13
2 1/2 Element Without Voltage Channel C	E-14
Connecting to a Potential Transformer (PT)	E-15
Connecting to a Current Transformer (CT)	E-17
Connecting to an Isolated Current Transformer (ISO)	E-18

Verifying Voltage and Current Connections

Introduction

Correct voltage and current connection of single phase, split phase, or polyphase connections can be verified using phasor diagrams. Phasor diagrams are graphic representations that show the magnitude and angular relationship of voltage and current for each phase of a monitored connection. Each connection diagram on the following pages shows the correct voltage and current phasor diagrams (for resistive loads) for that circuit.

Displaying the screen

To display the Voltage and Current Phasor screen, from the Home screen press Phasor. The following screen depicting Positive Sequence 3 Phase Delta resistive load will appear.

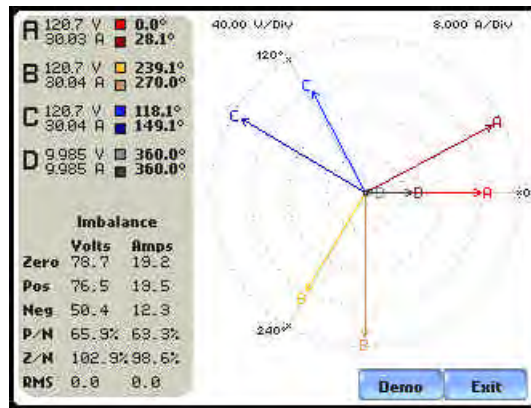

MARK241

The touch screen Demo button presents an animated phasor demo rotation for resistive, capacitive and inductive loads.

Single Phase resistive load

A single phase voltage or current phasor is displayed as a single line showing a channel reference at 0 degrees and a magnitude relative to its measured value. An arrow head on the line indicates direction.

Split phase

Split phase vectors are displayed as dual lines showing channel references and magnitudes and opposite (180 degrees) directions.

Three phase

Three phase vectors are displayed as three lines, 120 degrees apart in a resistive load (unity power factor). Phase displacement will occur in a reactive or capacitive load.

Continued on next page

Incorrect current phasor diagram

Phasor displays that show incorrect current probe connection can be corrected by reconnecting the probe so that the arrow on the probe handle points toward the load.

The PowerVisa is able to display diagrams of the various wiring configurations to assist users in the selection of circuit type appropriate for their application (see Chapter 5 Start Menu - Circuit Type Selection on page 5-11). The instrument compares the detected voltages, currents, and phase sequence (if applicable) to the selected circuit type. The PowerVisa issues a message if the specified circuit type and the actual voltage/current connections match.

The next pages describe and illustrate the wiring configurations available for set up in PowerVisa.

WARNING

Interconnect Jumpers bearing part number 114013-G1 supplied with the standard cable set can be used to bond the same conductor points together. To reduce the risk of fire, electric shock, or physical injury, it is strongly recommended that connections be made with all circuits de-energized and current carrying conductors fused. If it is necessary to make connections on energized circuits, these must be performed by Qualified Personnel ONLY with Proper Personal Protective Equipment.

Single Phase

Introduction When making voltage connections to a single phase circuit use channel A differential inputs as shown below. The figure also shows voltage connection using channel D as a differential input for measuring neutral to ground voltage. Neutral to ground measurements are important but optional.

NOTE Be sure to connect the current probe with the arrow on the handle pointing towards the load or an erroneous power reading will result.

Connection diagram

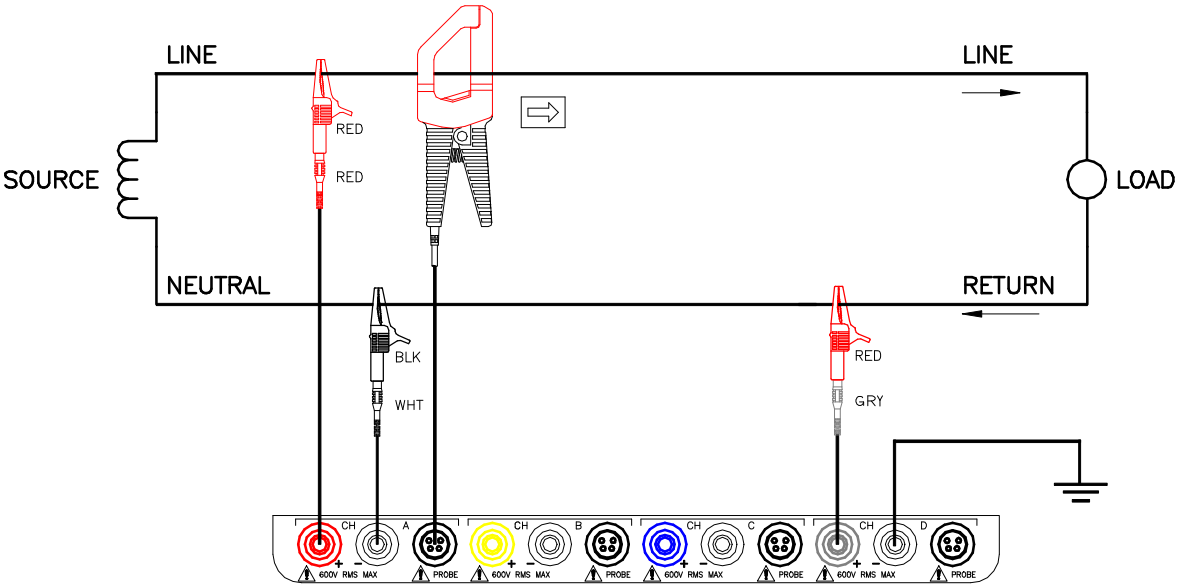

PX5-901

Phasor diagrams

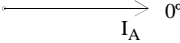
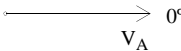

Split Phase

Introduction

When making split phase measurements, use both channels A and B for voltage and current connections. The neutral is chosen as the reference for measurement purposes. The figure also shows voltage connection using channel D as a differential input for measuring neutral to ground voltage. Neutral to ground measurements are important but optional.

Connection diagram

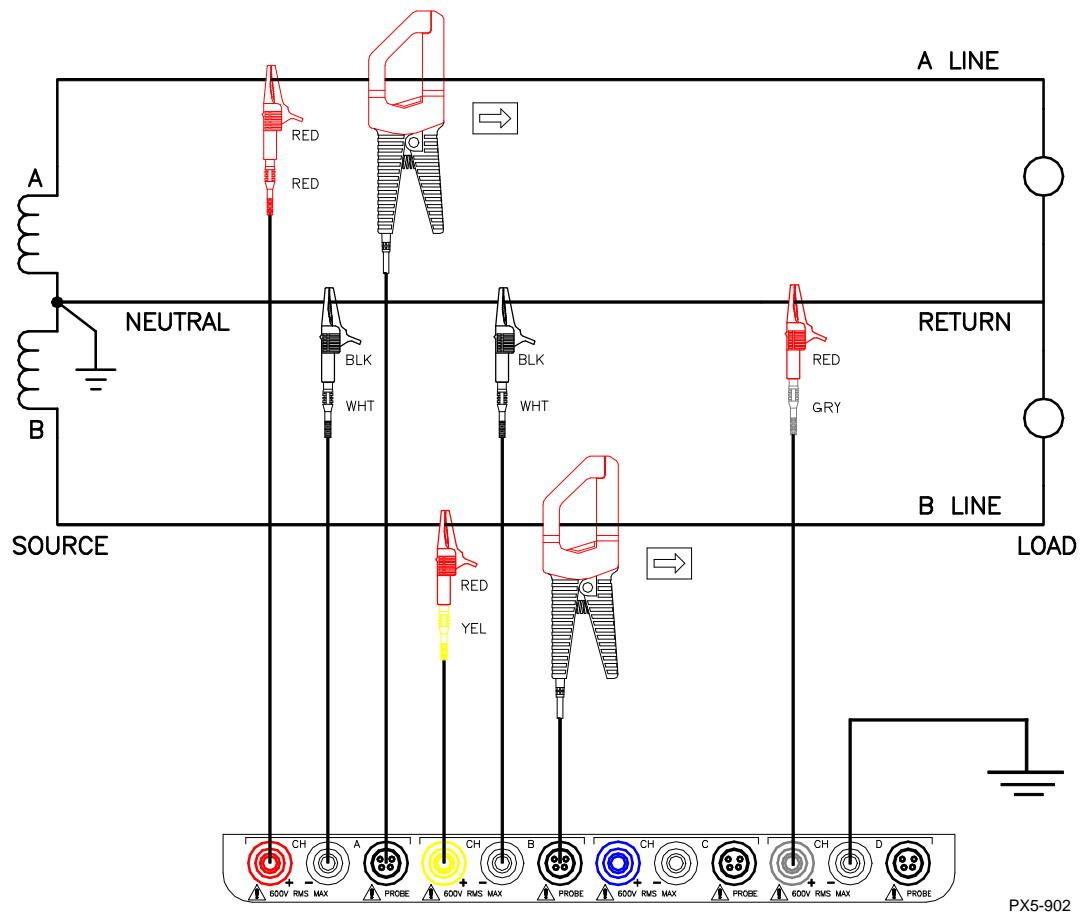

Phasor diagrams



3 Phase, Four Wire Wye

Introduction

Channels A, B, and C are connected to voltage and current probes. The neutral is connected to common and is the reference for the three channels. The figure also shows voltage connection using channel D as a differential input for measuring neutral to ground voltage. Neutral to ground measurements are important but optional.

Connection diagram

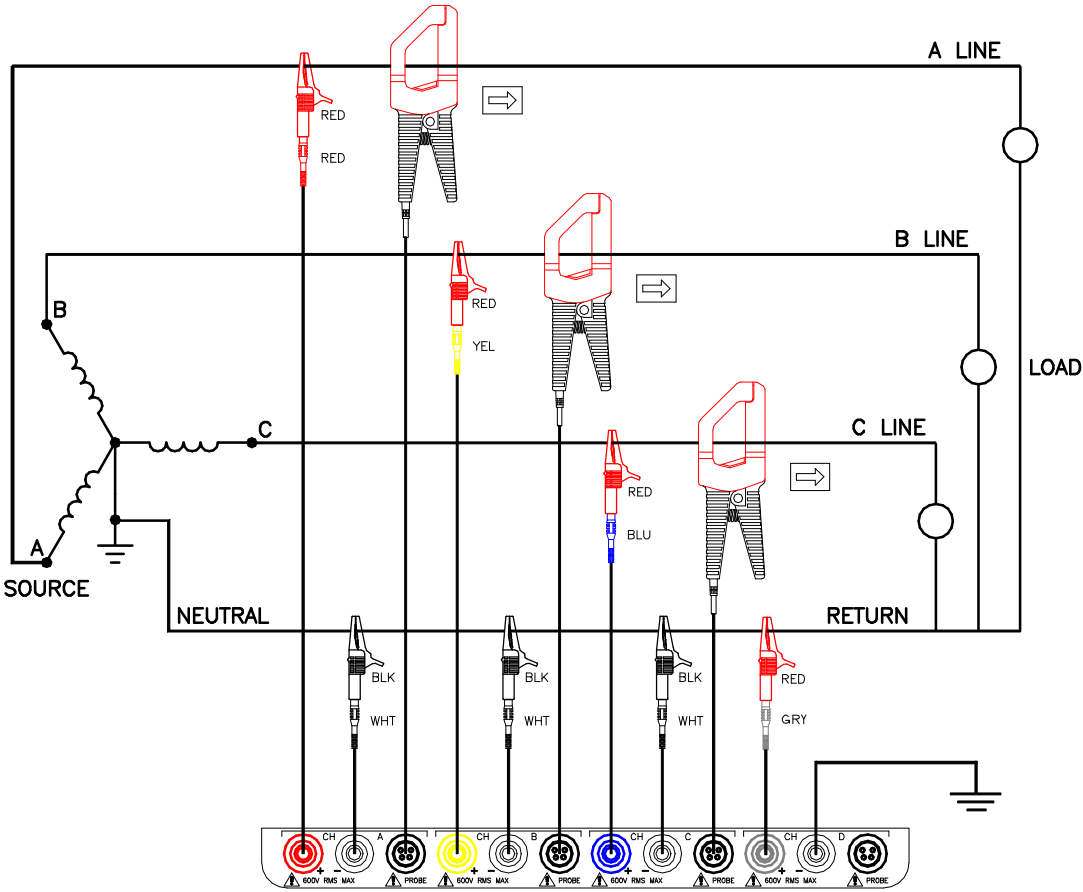

PX5-903

Phasor diagrams

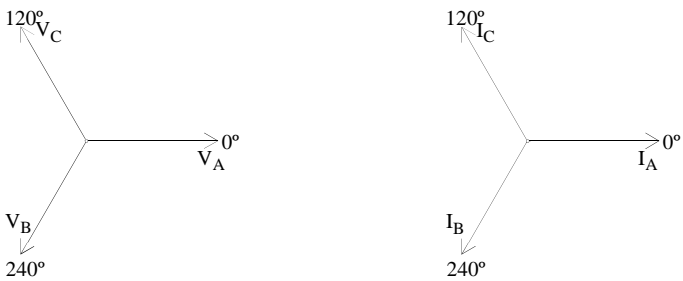

3 Phase (Floating or Grounded) Delta

Introduction

In this power connection, the PowerVisa uses voltage channels A, B, and C as differential inputs with channel A using source voltage A-B, channel B using B-C, and channel C using C-A as the reference. Current probes are connected to channels A, B, and C. Neutral to ground measurements are important but optional.

Connection diagram

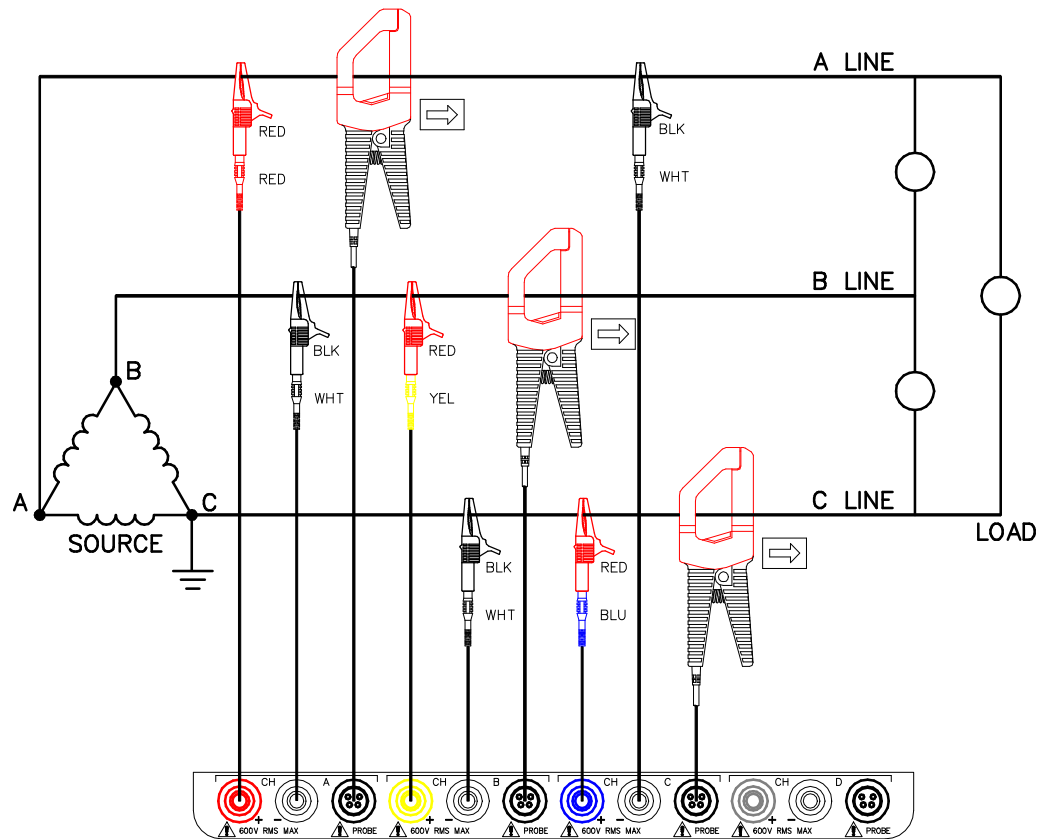

PX5-904

Floating Delta phasor diagrams

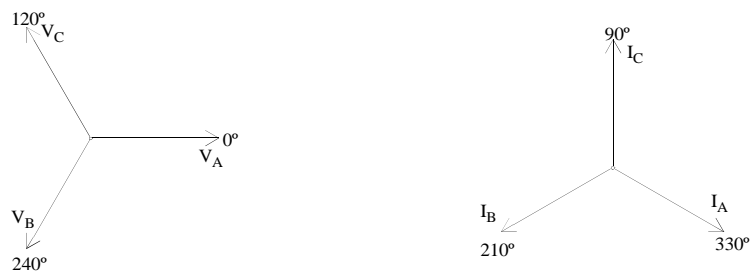

3 Phase 2-Watt Delta

Introduction The figure below shows the 3 Phase 2-Watt delta connection using phase channels A-B-C. Current probes are connected to channels A and B. Neutral to ground measurements are important but optional.

Connection diagram

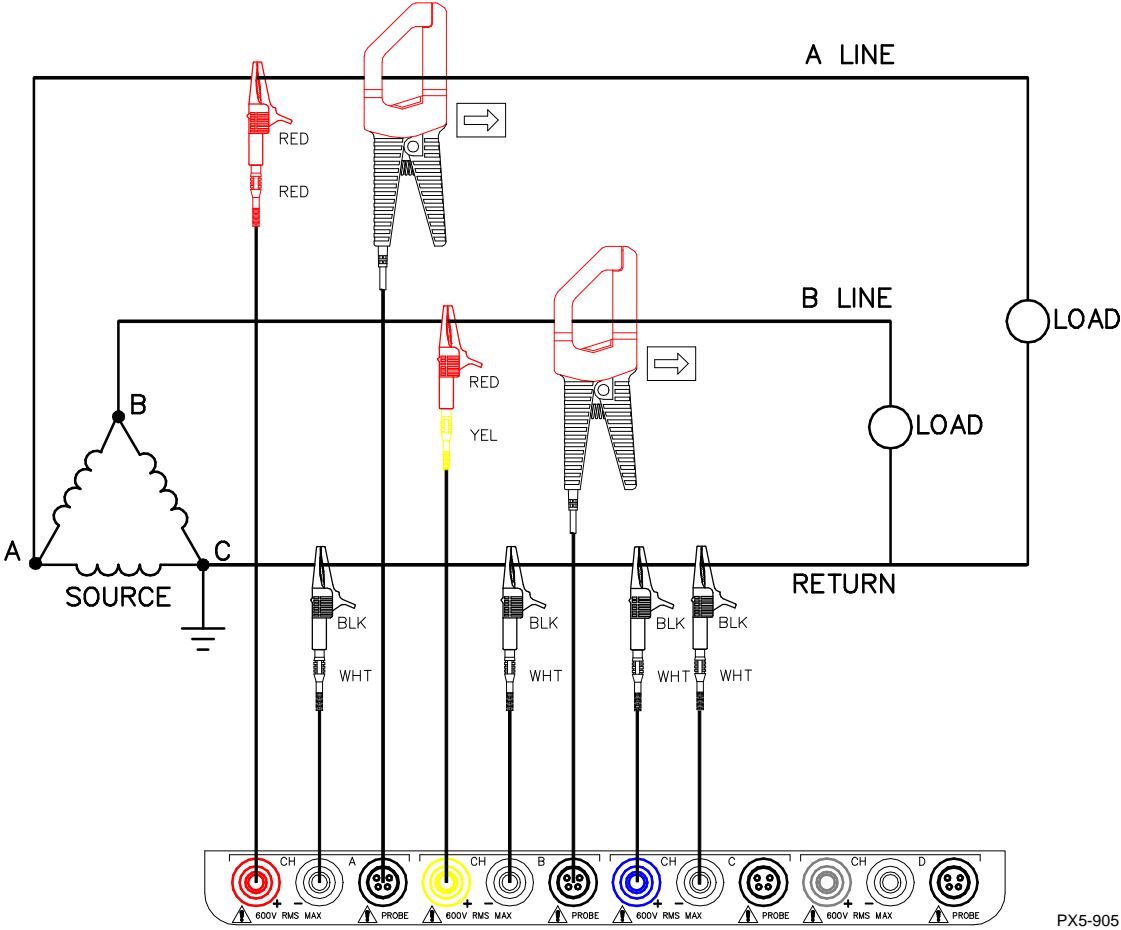

PX5-905

Phasor diagrams

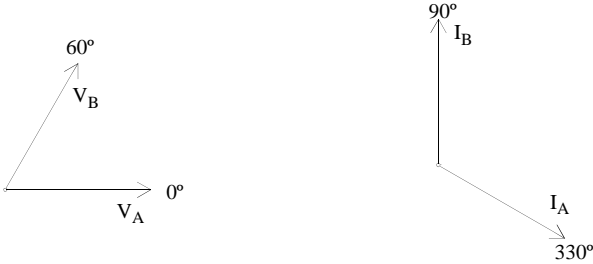

Generic Circuit

Introduction In the Generic circuit connection, the PowerVisa uses voltage channels A, B, C, and D as differential inputs. Current probes are connected to channels A, B, C, and D.

Connection diagram

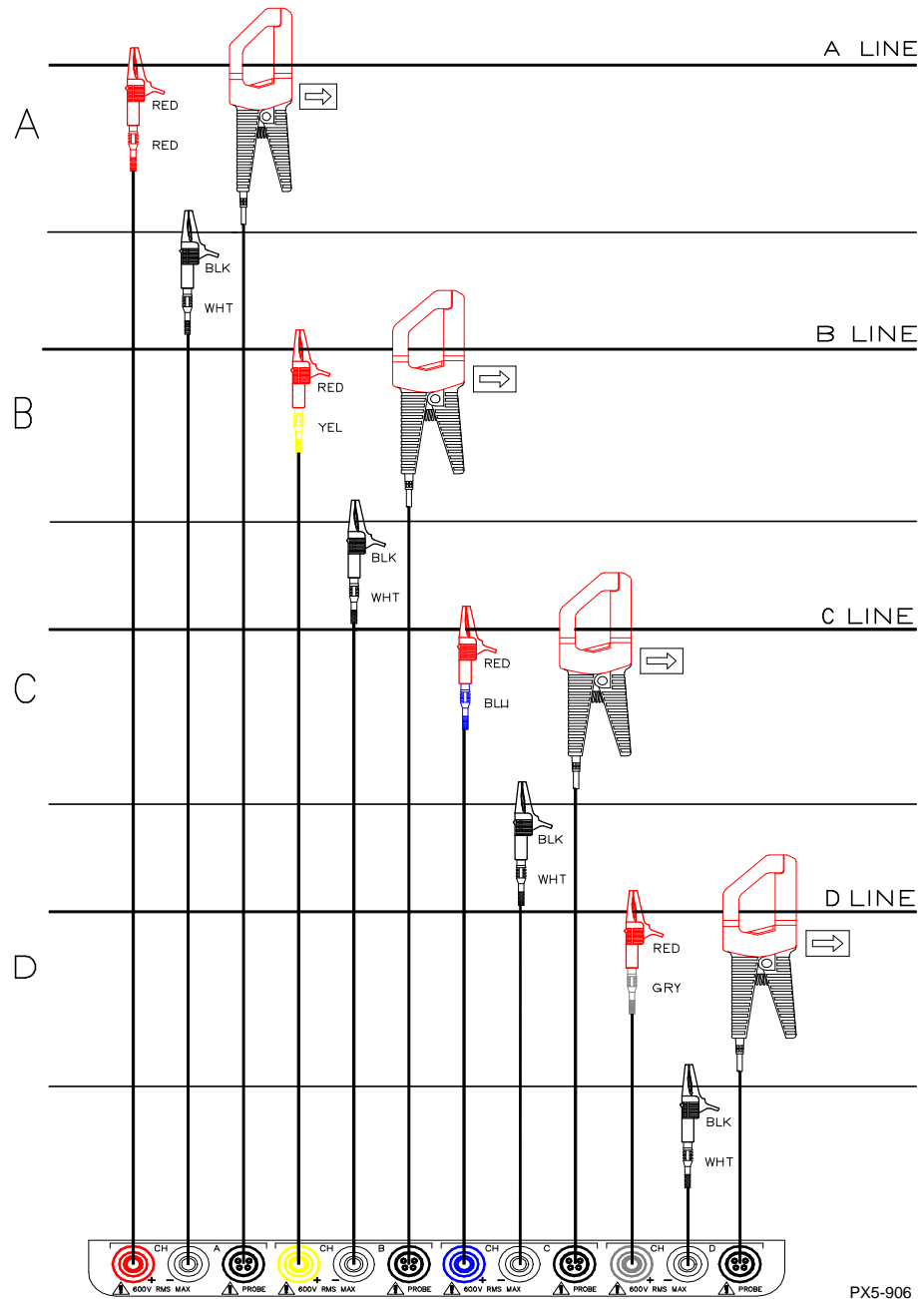

PX5-906

2 1/2 Element Without Voltage Channel B

Introduction

Channels A and C are connected to voltage. Current probes are connected to channels A, B and C. The neutral is connected to common and is the reference for the three channels. The figure also shows voltage connection using channel D as a differential input for measuring neutral to ground voltage. Neutral to ground measurements are important but optional.

Connection diagram

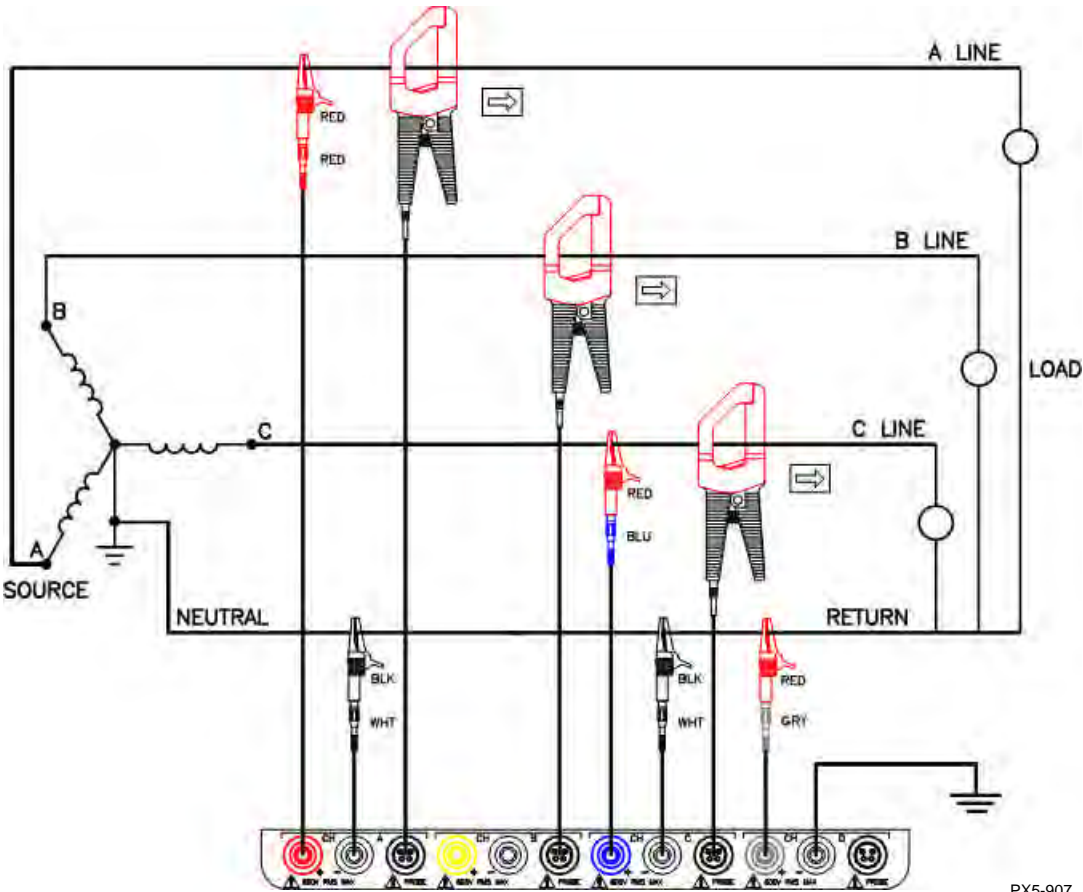

Phasor diagrams

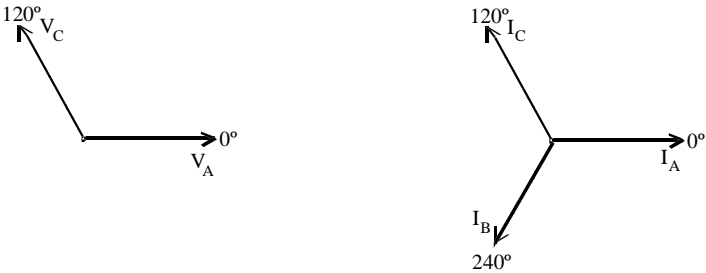

2 1/2 Element Without Voltage Channel C

Introduction

Channels A and B are connected to voltage. Current probes are connected to channels A, B and C. The neutral is connected to common and is the reference for the three channels. The figure also shows voltage connection using channel D as a differential input for measuring neutral to ground voltage. Neutral to ground measurements are important but optional.

Connection diagram

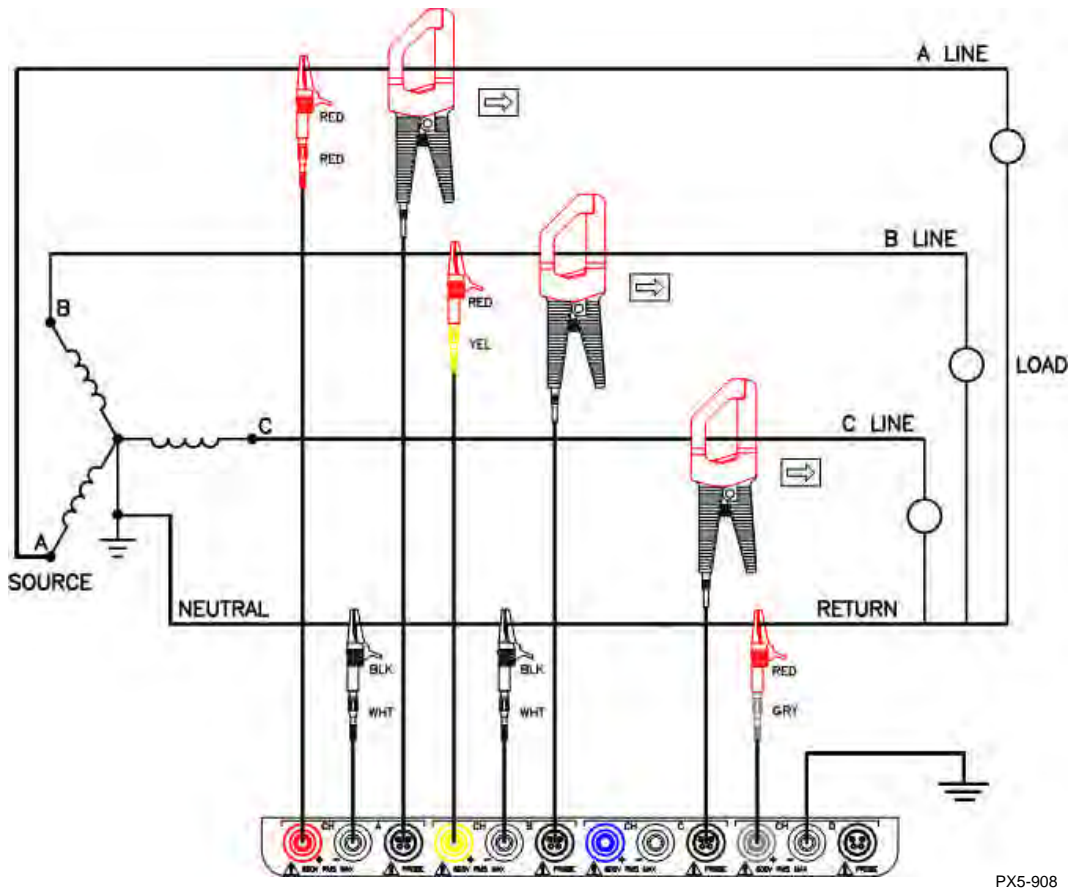

Phasor diagrams

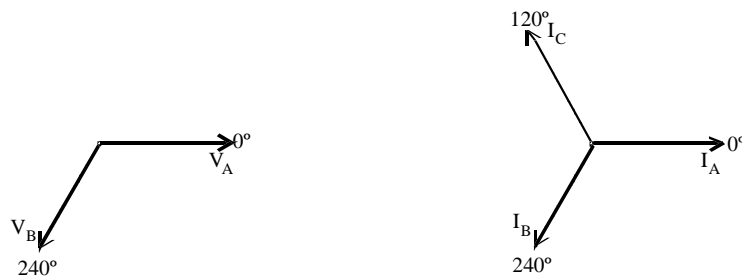

Connecting to a Potential Transformer

Safety Precautions

Follow the safety precautions listed on page E-3 when making all potential transformer connections.

NOTE

Potential Transformers are not manufactured by Dranetz-BMI and are discussed here for informational purposes only.

Definition

A potential transformer (PT), also referred to as a voltage instrument transformer, provides the necessary step-down ratio to reduce the high voltage of circuits above 600 Vrms to a level for safe measurement. A PT also provides isolation and proper connections for instrument attachment.

Connections

PTs are usually fixed in position and require that the voltage probe(s) be connected to their terminal connections.

WARNING

Refer to the manufacturer's instructions, related to the PT, for exact information for probe connection for voltage monitoring. Do not exceed 600 Vrms input to the PowerVisa voltage inputs.

ADVERTENCIA

Consulte las instrucciones del fabricante referentes a TP (transformador potencial), para la información exacta de la conexión de sonda a fin de monitorear el voltaje. No supere la entrada de 600 Vrms a las entradas de voltaje de PowerVisa.

AVERTISSEMENT

Se reporter aux instructions du fabricant relatives au transformateur de tension (Potential Transformer - PT) pour obtenir les renseignements exacts sur la connexion de sonde utilisée pour la surveillance du courant. Ne pas dépasser l'entrée de tension efficace de 600 RMS dans les entrées de tension de PowerVisa volts.

WARNUNG

Genauere Informationen zur Meßfühlerverbindung für die Spannungsüberwachung entnehmen Sie bitte den Anleitungen des Herstellers (siehe Spannungsteilertransformator). Die Eingangsspannung von 600 V (Effektivwert) in die PowerVisa Spannungseingänge sollte nicht überschritten werden.

Procedure Follow these steps to connect voltage probes to a potential transformer.

Step	Action
1	Turn off power to the PT.
2	Connect the colored voltage probes to the channel inputs on the PowerVisa top panel.
3	Connect the colored voltage probes to the PT's connections in accordance with the manufacturer's instructions.
4	Turn on power to the PT.

Scale factor The scale factor of the PT must be accounted for in making accurate voltage measurements. Because the monitored output voltage of the PT is stepped-down (divided) from the original voltage, this ratio must be stepped-up (multiplied) by the PowerVisa when voltage computations are performed. The PT scale factor is usually mounted on the PT assembly and is entered into the PowerVisa on the scale factors screen (refer to page 5-10). Refer to the PT manufacturer's literature for the scale factor for the device you are using.

Connecting to a Current Transformer (CT)

Safety precautions

The following safety precautions apply to current transformer (CT) connections in addition to those safety precautions stated on page E-3.

- Never energize a CT with the secondary open.
- Never disconnect the secondary of a CT with primary energized.

WARNING

Refer to the manufacturer's instructions related to the CT for exact information for connections for current monitoring. Do not exceed manufacturer's ratings.

ADVERTENCIA

Consulte las instrucciones del fabricante referentes a TC (transformador de corriente) para la información exacta de las conexiones a fin de monitorear la corriente. No exceda las capacidades nominales del fabricante.

AVERTISSEMENT

Se reporter aux instructions du fabricant relatives au transformateur de courant (Current Transformer - CT) pour obtenir les renseignements exacts sur les connexions utilisées pour la surveillance du courant. Ne pas dépasser la puissance recommandée par le fabricant.

WARNUNG

Genau Informationen zu Verbindungen für die Stromüberwachung entnehmen Sie bitte den Anleitungen des Herstellers (siehe Stromumwandler). Die Grenzwerte des Herstellers sollten nicht überschritten werden.

NOTE

Current Transformers are not manufactured by Dranetz-BMI and are discussed here for informational purposes only.

Description

Current transformers, also known as instrument transformers, reduce high level currents to low level currents so they can be safely monitored. These devices are similar to PTs used for voltage measurements in that both reduce values for safe measurement. The reduction, or step-down ratio, is stated as a scale factor that is used by the PowerVisa to step-up the measured value to its original value.

Types of CTs

There are single-phase CTs and polyphase CTs dependent on the source transformer used. Current reduction ratios vary widely and are also dependent on the source transformer used. Rating plates attached to the CT provide information as to the ratio and current limitations.

Connecting to an Isolated Current Transformer (ISO)

Introduction	Low current monitoring devices made by Dranetz are called isolated current transformers or ISO boxes. The Dranetz-BMI ISO box has a 5 A current range.
Safety precautions	<p>The following safety precautions apply to ISO box connections in addition to those safety precautions stated on page E-3.</p> <ul style="list-style-type: none">• Never energize an ISO box with the secondary open.• Never disconnect the secondary of an ISO box with primary energized.
WARNING	Physical injury or equipment damage could result if ISO boxes are improperly connected. Do not connect an ISO box between two conductors which are at different voltage potentials.
ADVERTENCIA	Podrían producirse lesiones físicas o daños al equipo si se conectan indebidamente las cajas del transformador aislado de corriente (ISO). No conecte una caja del ISO entre dos conductores que tengan distintos potenciales de voltaje.
AVERTISSEMENT	Une mauvaise connexion des transformateurs d'intensité isolés (ISO) peut provoquer des blessures corporelles ou des dégâts matériels. Ne pas relier les transformateurs ISO entre deux conducteurs de tensions différentes.
WARNUNG	Falsch angeschlossene ISO-Kästen (Isolierte Stromumwandler) können zu körperlichen Verletzungen oder Geräteschäden führen. Schliessen Sie einen ISO-Kasten nicht zwischen zwei Leiter mit unterschiedlichem Spannungspotential.
Connections to ISO box	The ISO box has terminal posts labeled X1 and X2 that are connected in series only with an ac current source. In normal connections, where phasing of current and voltages are important for power measurements, the X1 terminal is connected towards the source input line.

Continued on next page

Connections to ISO box (continued)

When connecting to CTs, the X1 terminal is normally connected to the H1 terminal of the device for correct reference phasing.

Where power measurements or voltage/current phase relationships are not important, the X1 and X2 terminals may be connected in series with the output device in any line (hot or return) or in any relationship of X1/X2.

Applications

ISO boxes can be used in a number of ways. These methods include:

- connecting them to the secondary of CTs for metering by the PowerVisa.
- inserting them in series with the load current to measure low current values.
- connecting them to a non-Dranetz clamp-on current transformer and using that CT to monitor current with the PowerVisa.

ISO box connection to a current transformer

The figure on the next page shows an ISO box connected from any current channel input to a permanently installed CT. The connection shown is made in the load return line for current monitoring only. Polarities of the ISO box and CT are kept in-phase by matching markings of X1 to H1. Scale factors of both devices must be multiplied together to get the resultant scale factor. The scale factor value calculated for a CT is 3.375.

Continued on next page

CAUTION DO NOT exceed current limits of the ISO box.

PRECAUCION NO exceda los límites de corriente de la caja del ISO.

ATTENTION NE PAS dépasser les limites d'intensité du transformateur ISO.

VORSICHT Die aktuellen Grenzwerte für den ISO-Kasten sollten NICHT überschritten werden.

**ISO box
connection to a
CT**

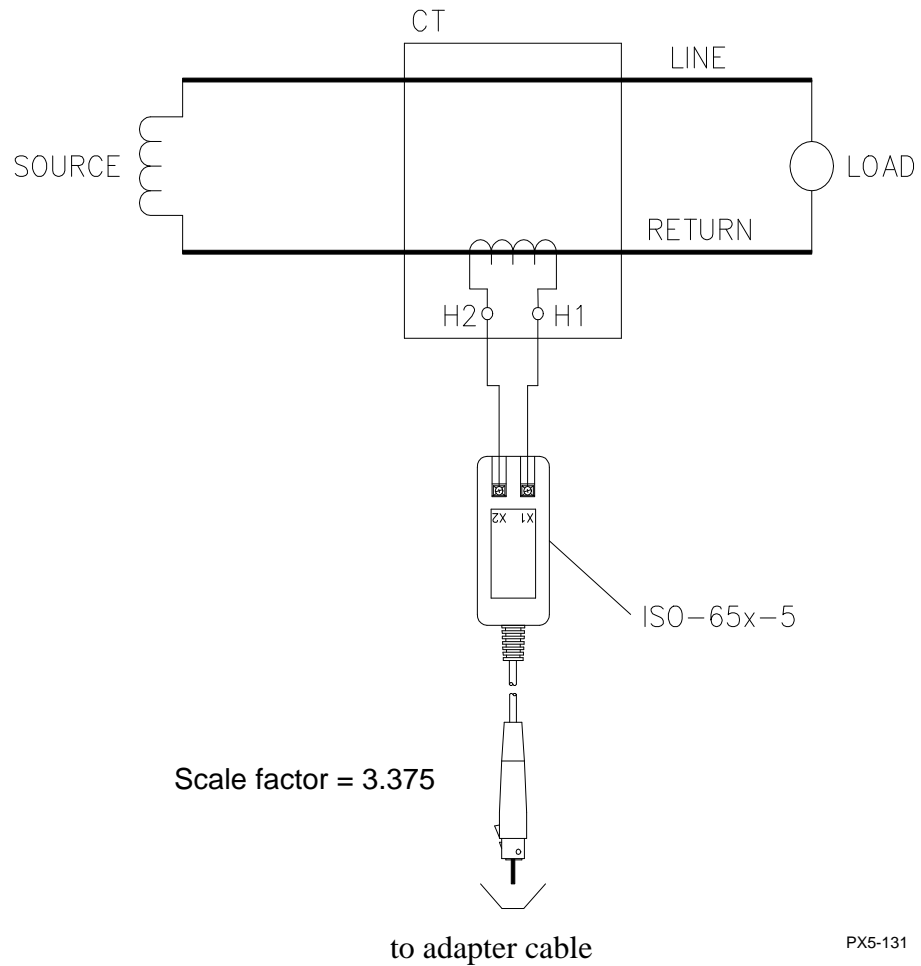

A P P E N D I X F



Event Classification

Range of Variations as per IEEE, IEC, and Dranetz-BMI

Events characterization implemented in the PowerVisa adheres to the IEEE 1159 and IEC 61000-4-30 Class A measurement standards. The range of variations as per IEEE and IEC standards are featured below, along with quality test measurements developed by Dranetz-BMI.

	IEEE 1159	IEC 61000-4-30 (deviations from IEEE 1159 only are noted)	Dranetz-BMI
Short Duration Variations			
<u>Magnitudes</u>			
Sag/Dip	(Sag) Vrms Below 90% (or Low limit) to 10% of nominal	(Dip) Vrms Below 90% (or Low limit) of nominal	
Swell	Vrms Above 110% (or High limit) to 180% of nominal	Vrms Above 110% (or High limit) of nominal	
Interruption	Vrms Below 10% (or Very Low limit) of nominal	Vrms Below 1% (or Very Low limit) of nominal	
<u>Temporal</u>			
Instantaneous	0.5 - 30 cycles		
Momentary	0.5 - 30 seconds		
Temporary	3 - 60 seconds		
Duration	begins when any one phase is Out of Limits; ends when all phases are Within Limits		
Long Duration Variations			
<u>Magnitudes</u>			
Sag	same magnitude values as Short Duration Variations (see above)		
Swell			
Interruption			
<u>Duration</u>			
Sustained	> 1 minute		
Cold Load Pickup is return from sustained			

Continued on next page

Range of Variations as per IEEE, IEC, and Dranetz-BMI (continued)

	IEEE 1159	IEC 61000-4-30 (deviations from IEEE 1159 only are noted)	Dranetz-BMI
Transients			
Impulsive	no more than one transition in each direction	IEC classification for transients are undefined, as of version approved in 2003.	Peak - absolute value from zero axis
Oscillatory	ringing freq following initial transition		Width - time between 50% of peak rise and fall
Medium Frequency	5 - 500 KHz		Duration - total time of waveshape trigger
frequency range	20 us		Rise - time between 10% and 90% of peak
duration	0 - 8 pu above Vnom		Fall - time between 90% and 10% of peak
magnitude			Direction: Positive - adds energy to curve; Negative - subtracts energy from curve
			Ring frequency - dominant between 2nd and 128th harmonic

Continued on next page

Range of Variations as per IEEE, IEC, and Dranetz-BMI (continued)

	IEEE 1159	IEC 61000-4-30 (deviations from IEEE 1159 only are noted)	Dranetz-BMI
Waveform Distortion (measured as steady state values from 10/12 cycle calculations)			
DC Offset			
frequency range			
magnitude	0 - 0.1%		
Harmonics			
frequency range	DC - 100th		
magnitude	0 - 20%		
Interharmonics			
frequency range	0 - 6 KHz		
magnitude	0 - 2%		
Notching			
frequency range	35 KHz		
magnitude			
Noise			
frequency range	Broadband		
magnitude	0 - 1%		



A P P E N D I X G



PowerVisa Menu Structure

Menu structure description

The PowerVisa menu screen maps are shown in the following pages. Use the Level number and Heading as guide to navigate through the different menu screens. Each screen contains touch screen buttons which lead to related functions.

In this appendix

The following screen maps are shown in this appendix.

Level No.	Heading	See Page
001	Home Screen	G-2
100/1	Start Menu - Automatic Setup	G-3
100/2(a) 100/2(b)	Start Menu - Wizard Setup	G-4/a G-4/b
100/3(a) 100/3(b)	Start Menu - Monitor Same Circuit	G-5/a G-5/b
100/4	Start Menu - Load setup template from card	G-6
100/5	Start Menu - Load data from card	G-6
150	Instrument Settings	G-7
108	Circuit Type Selection	G-8
200	Scope Mode	G-9
300/1	Meter Mode - Standard	G-10
300/2	Meter Mode - Distortion	G-11
220	Harmonics	G-12
240	Phasor Display	G-13
112_101	Advanced Options - Transient Limit	G-14
112_201	Advanced Options - RMS Variation Limit	G-15
112_301	Advanced Options - Waveform Capture	G-16
112_401	Advanced Options - Characterizer Options	G-16
112_501	Advanced Options - Journal Limit	G-17
112_601	Advanced Options - Journal Interval	G-18
112_701	Advanced Options - EN50160	G-19
400	Events	G-20
401	Event Options	G-21
430	Trend	G-22
470(a)	Reports - EN50160	G-23/a
470(b)	Reports - PQ Status	G-23/b

LEVEL 001
Home Screen

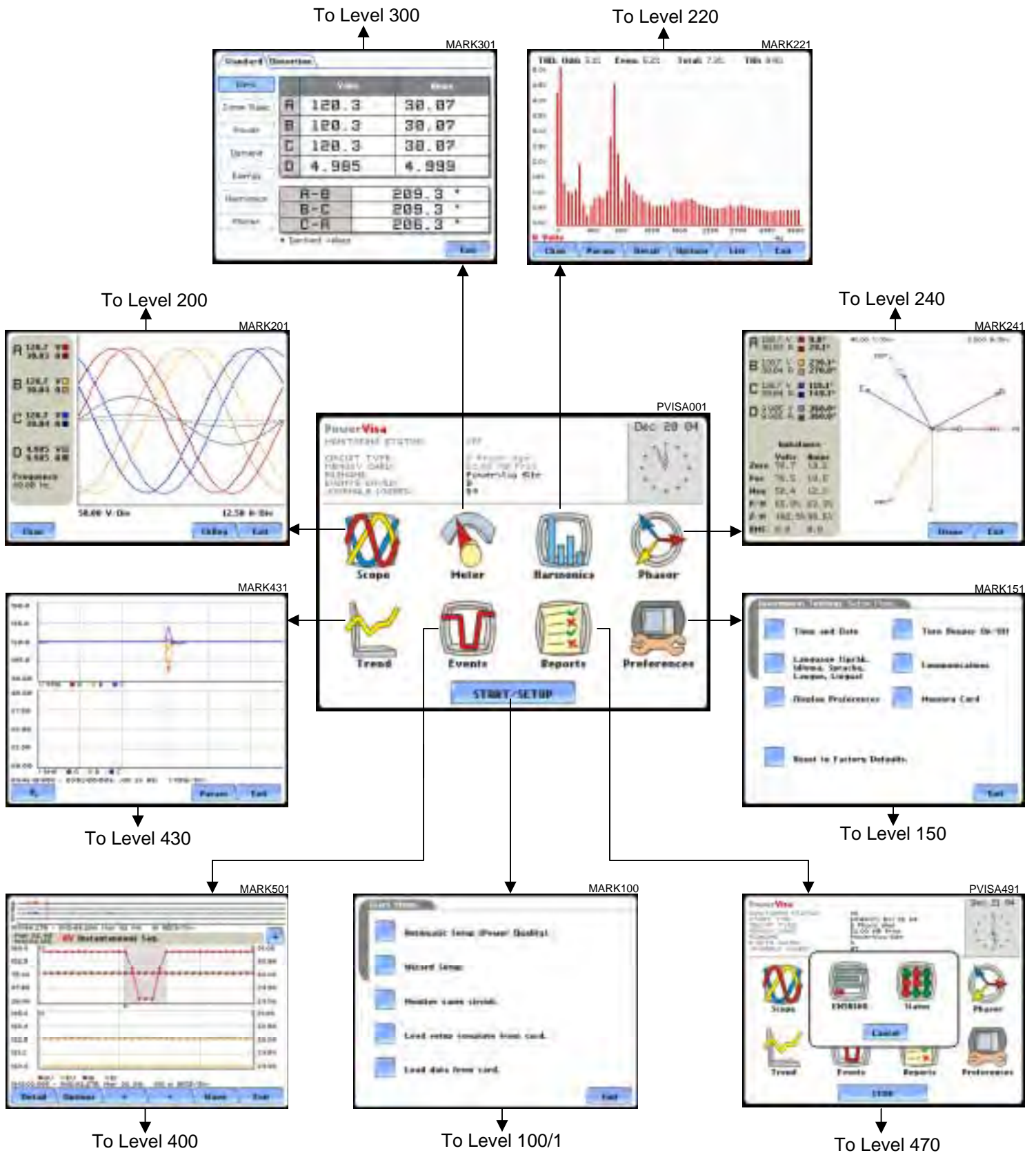

LEVEL 100/1

Start Menu - Automatic Setup

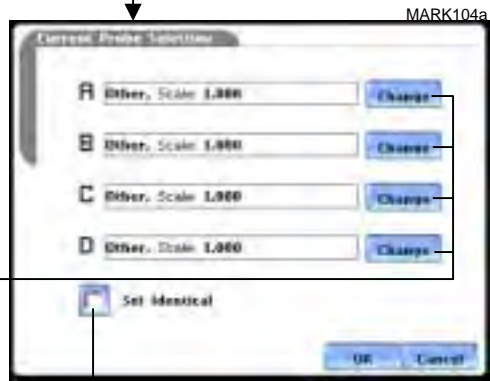
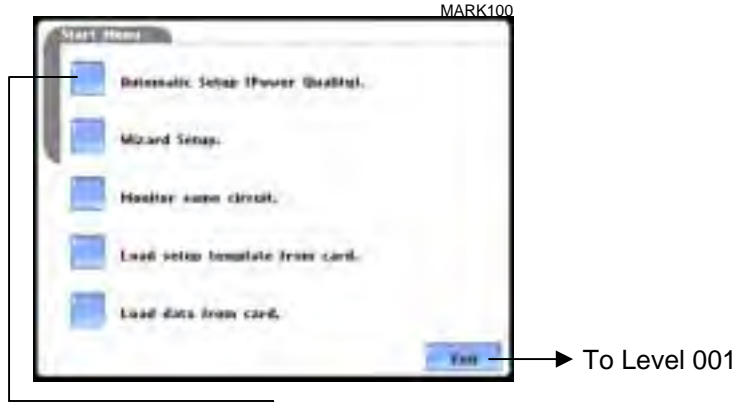

LEVEL 100/2(a)
Start Menu - Wizard Setup



→ To Level 001

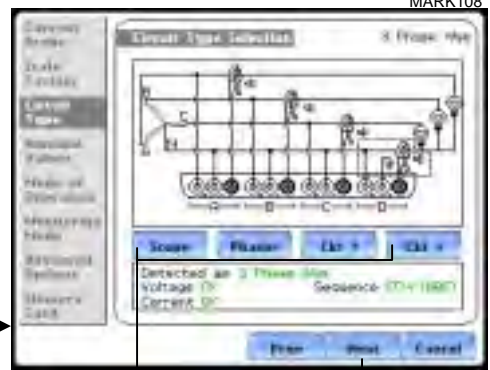
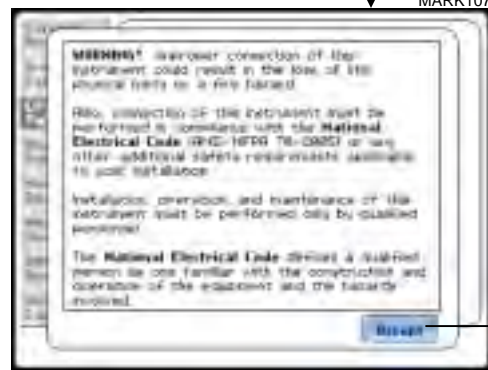
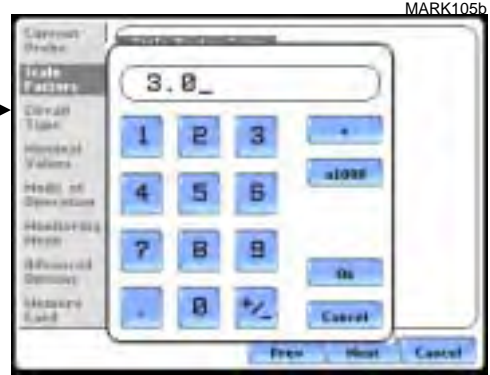
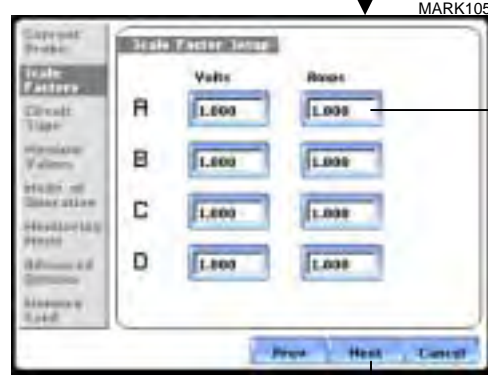
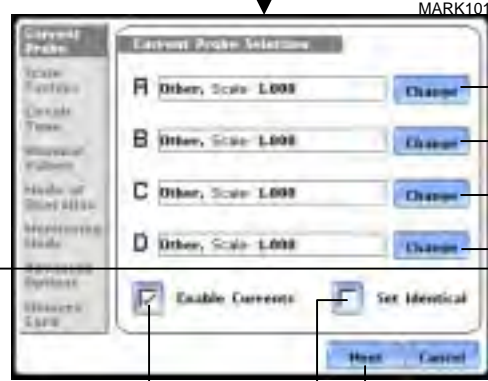
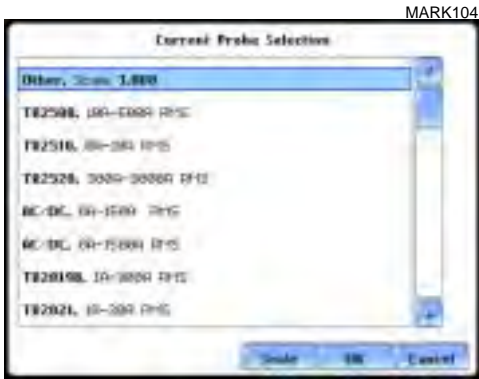

→ To Level 108

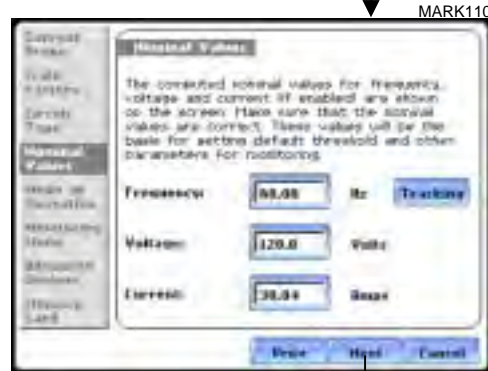

cont. next page

LEVEL 100/2(b)
Start Menu - Wizard Setup



MARK109



GUIA111

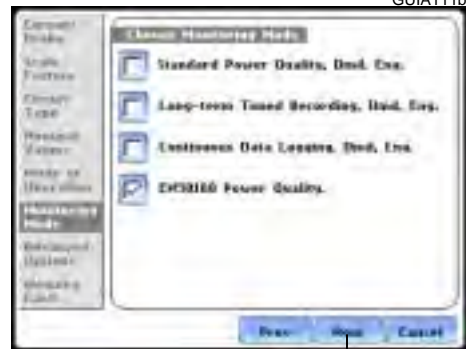

GUIA111b



MARK112

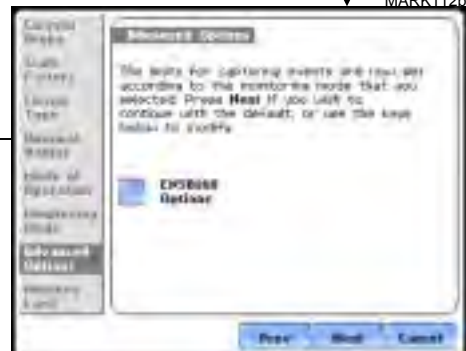

MARK112b

→ To Level 112 ←



VISA113

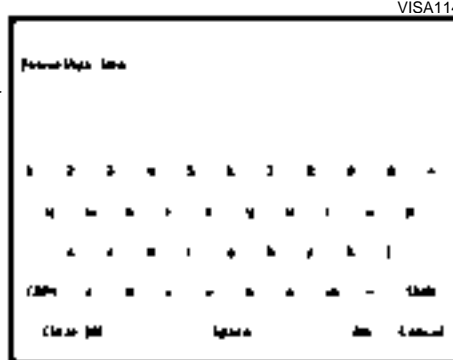

VISA114



VISA115

LEVEL 100/3a

Start Menu - Monitor Same Circuit

MARK100



PVISA122



MARK121



MARK123

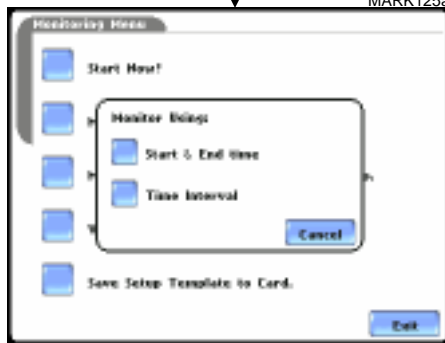

MARK125a

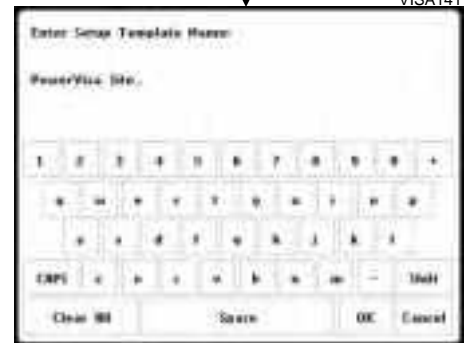

VISA141

TO LEVEL 100/3b

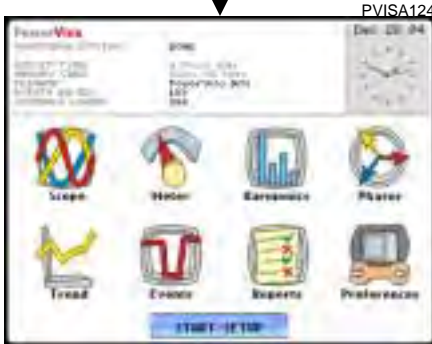

PVISA124



MARK136



MARK123b



VISA123

LEVEL 100/3b

Start Menu - Monitor Same Circuit

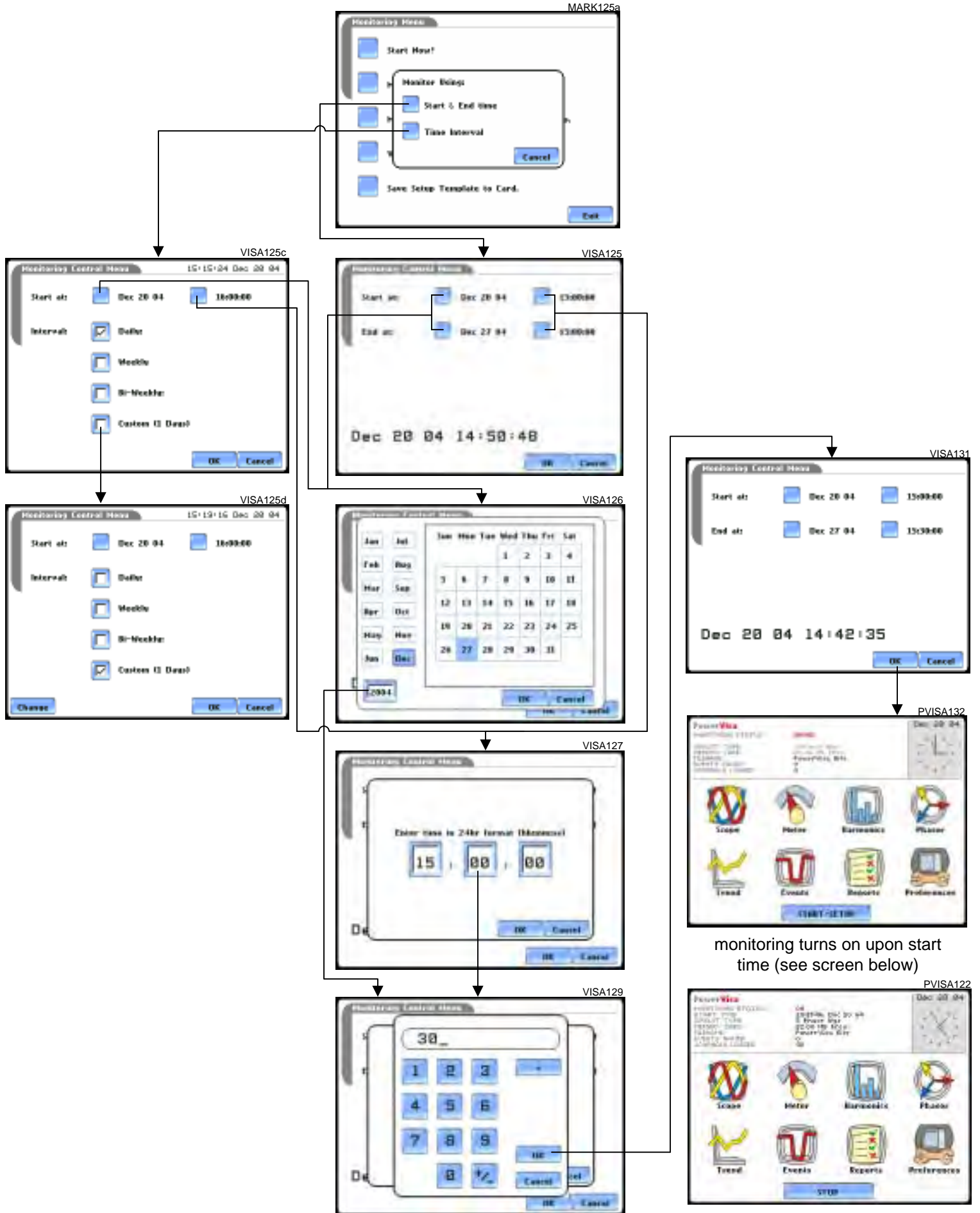

LEVEL 100/4

Start Menu - Load Setup Template from Card

MARK100

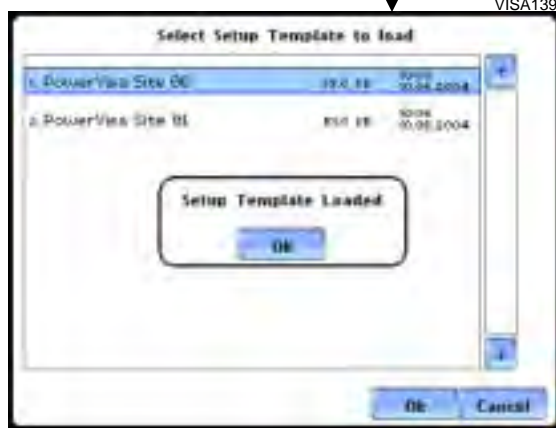
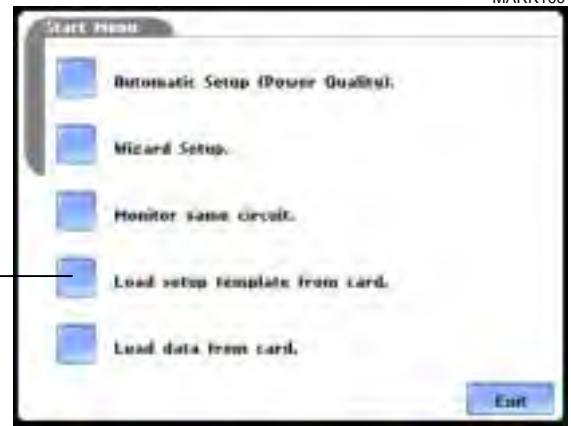
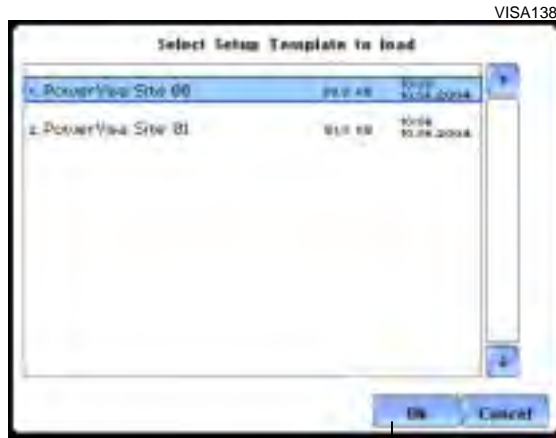

LEVEL 100/5

Start Menu - Load Data from Card

MARK100

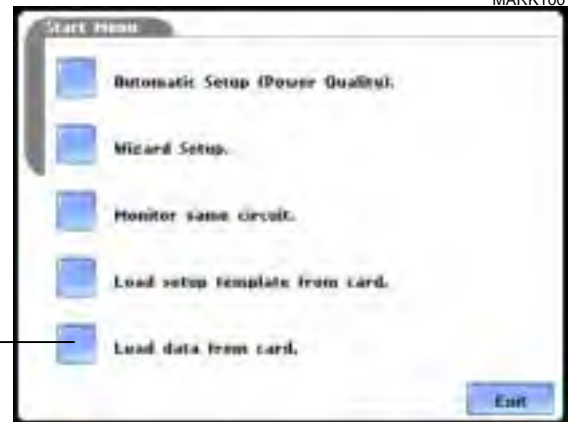

LEVEL 150 Instrument Settings

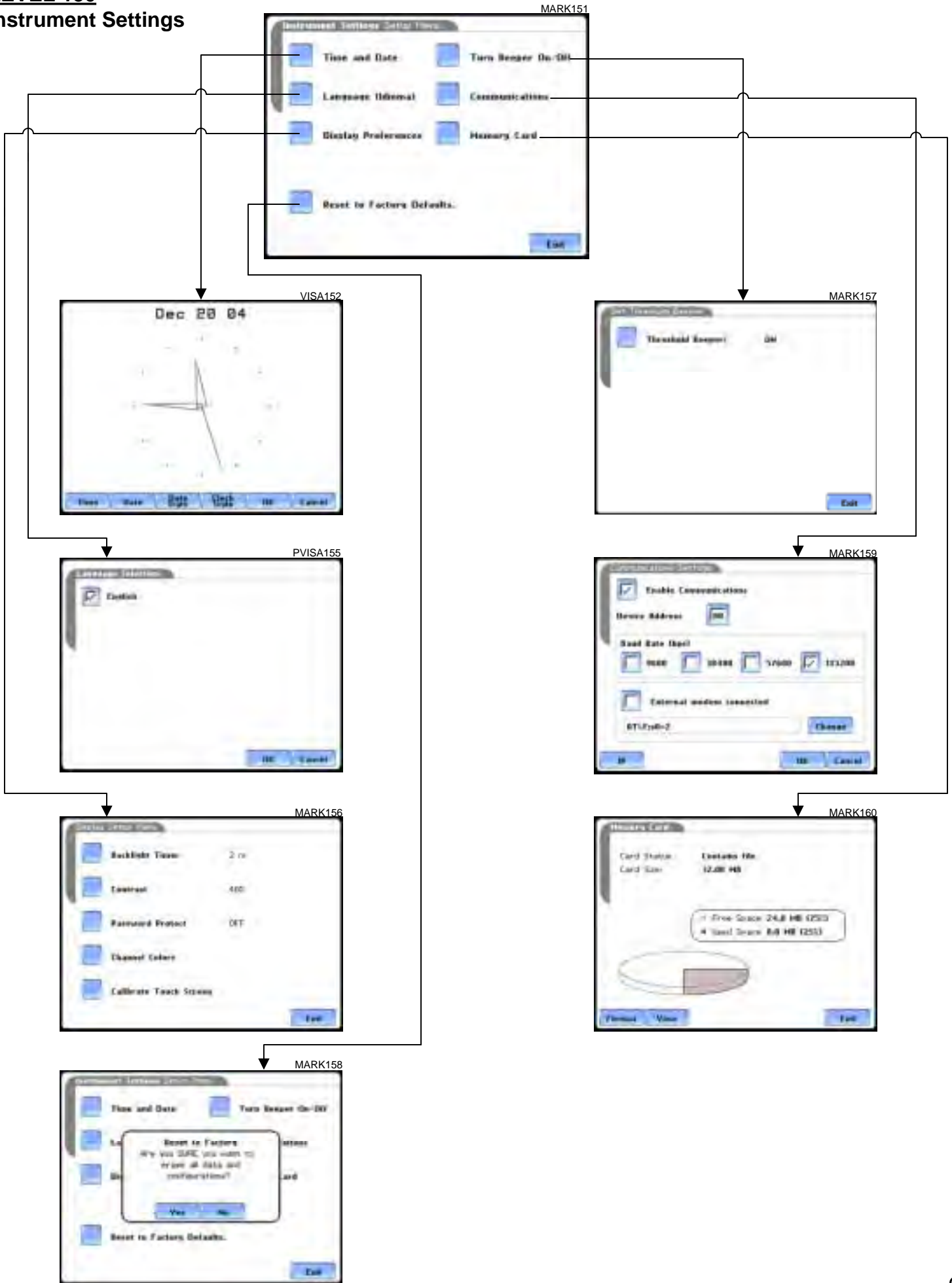

LEVEL 108 Circuit Type Selection

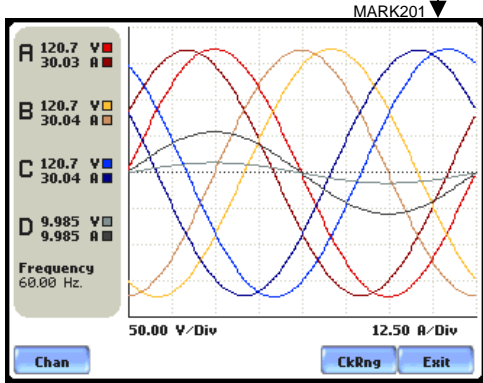
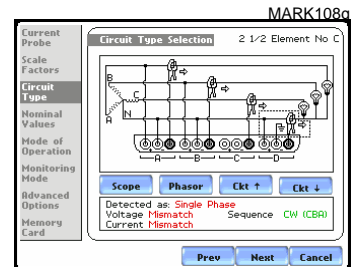
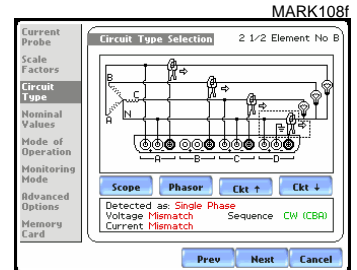
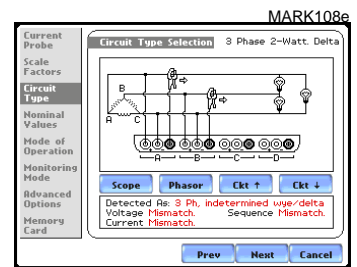
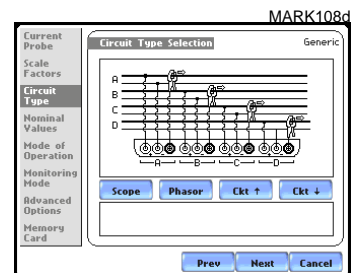
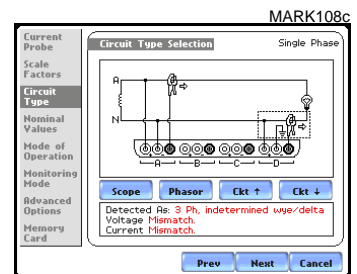
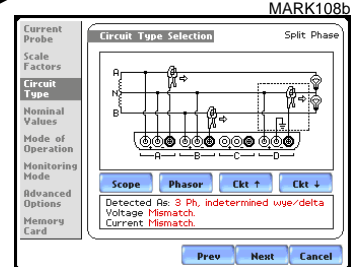
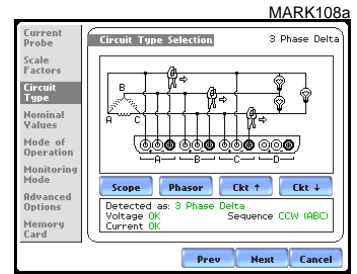
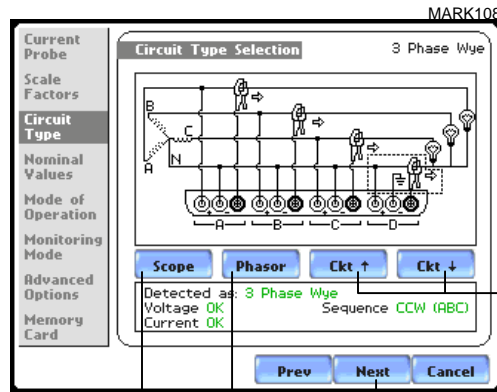

To Level 200

See Level 100/1

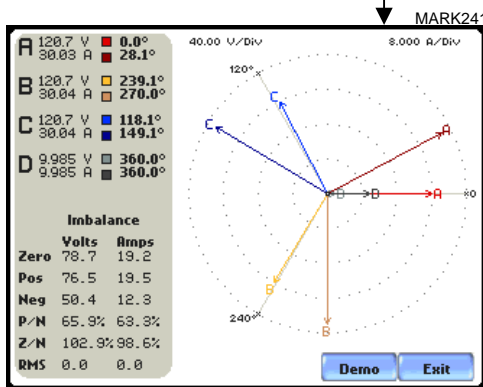

To Level 240

LEVEL 200
Scope Mode

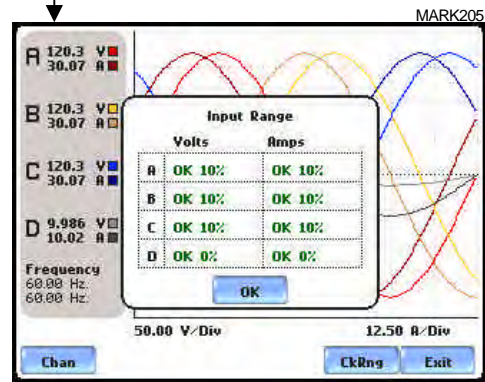
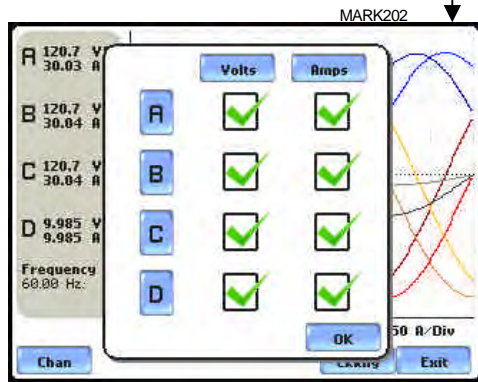
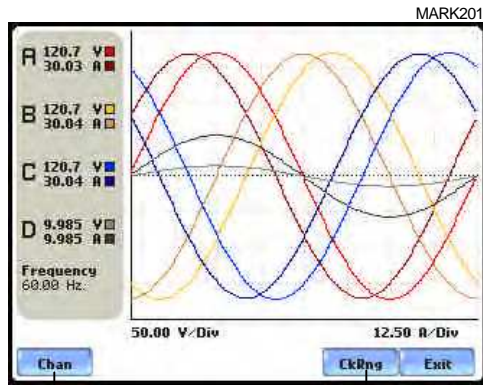

LEVEL 300/1
Meter Mode - Standard

MARK301PG

Standard Distortion		
Basic	Volts	Amps
Comp Basic	A 120.3	30.07
Power	B 120.3	30.07
Demand	C 120.3	30.07
Energy	D 4.985	4.999
Harmonics	A-B	209.3 *
Flicker	B-C	209.3 *
	C-A	206.3 *

* Derived values

Exit

MARK302PG

Standard Distortion		
Basic	Vector Displacement PF	-0.999
Comp Basic	Arithmetic Displacement PF	-0.999
Power	Residual Current	0
Demand	Net Current	0
Energy		
Harmonics		
Flicker		

Exit

MARK307PG

Standard Distortion			
Basic	Pst	Plt(Slide)	Plt
Comp Basic	A 9.990	0	0
Power	B 10.02	0	0
Demand	C 9.390	0	0
Energy			
Harmonics			
Flicker			

Exit

MARK303PG

Standard Distortion					
Basic	MWts	VA	VAR	TPF	DPF
Comp Basic	A 25.42K	29.10K	<0.01	-0.873	-0.882
Power	B 25.36K	29.57K	<0.01	-0.858	-0.858
Demand	C 25.36K	29.57K	<0.01	-0.858	-0.858
Energy	D -3.671K	3.671K	<0.01	-1.000	-1.000
Harmonics	Tot 76.14K	88.25K	<0.01	-0.863	-0.999
Flicker					

Exit

MARK306PG

Standard Distortion			
Basic	V THD	I THD	Harm Pur Assigned
Comp Basic	A 0	1.000	0
Power	B 0	0.998	0
Demand	C 0	1.000	0
Energy	D 0.104	0.841	0
Harmonics			
Flicker			

Exit

MARK304PG

Standard Distortion		
Basic	Active Power Demand	0
Comp Basic	Apparent Power Demand	0
Power	Reactive Power Demand	0
Demand	RMS Current Demand Ph A	0
Energy	RMS Current Demand Ph B	0
Harmonics	RMS Current Demand Ph C	0
Flicker	RMS Current Demand Avg	0

Exit

MARK305PG

Standard Distortion			
Basic	Watt hrs	VA hrs	VAR hrs
Comp Basic	A 0	0	0
Power	B 0	0	0
Demand	C 0	0	0
Energy	D 0	0	0
Harmonics	Tot 0	0	0
Flicker			

Exit

LEVEL 300/2
Meter Mode - Distortion

MARK311PG

Standard Distortion

THD

TID

TIF

Crest Factor

Power

Transformer

	VTHD fund	ITHD fund	VTHD RSS	ITHD RSS
A	0.098	1.000	0.201	0.213
B	0.016	0.998	0.016	0.212
C	0.098	1.000	0.201	0.213
D	0.104	0.841	<0.01	0.537

Exit

Standard Distortion

THD

TID

TIF

Crest Factor

Power

Transformer

	V TID fund	I TID fund	V TID RSS	I TID RSS
A	0	0	0	0
B	0	0	0	0
C	0	0	0	0
D	0	0	0	0

Exit

Standard Distortion

THD

TID

TIF

Crest Factor

Power

Transformer

	Derating Factor	K Factor
A	∅	∅
B	∅	∅
C	∅	∅
D	∅	∅

Exit

Standard Distortion

THD

TID

TIF

Crest Factor

Power

Transformer

	V TIF fund	I TIF fund	V TIF RMS	I TIF RMS	TIF Prod
A	0	0	0	0	0
B	0	0	0	0	0
C	0	0	0	0	0
D	0	0	0	0	0

Exit

Standard Distortion

THD

TID

TIF

Crest Factor

Power

Transformer

	Signed	Unsigned
A	∅	∅
B	∅	∅
C	∅	∅
D	∅	∅

Exit

Standard Distortion

THD

TID

TIF

Crest Factor

Power

Transformer

	Volts Crest Factor	Amps Crest Factor
A	∅	∅
B	∅	∅
C	∅	∅
D	∅	∅

Exit

LEVEL 220 Harmonics

MARK221

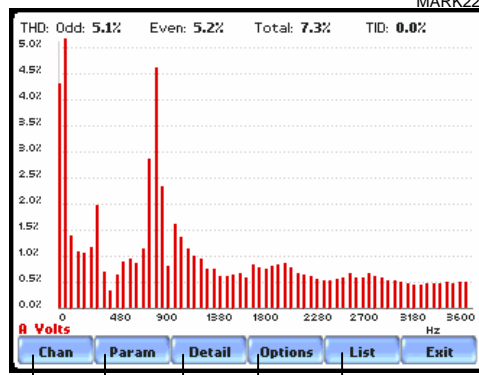

switch channel display
switch to V, I, or W

toggle between graphical
harmonics and list of harmonics

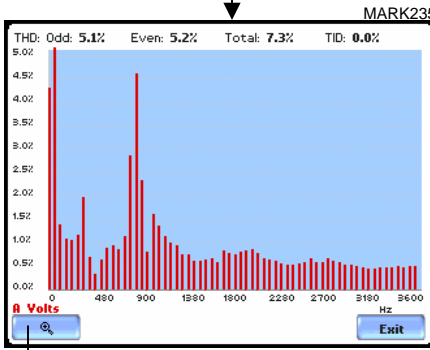

Hz	Volts	Harmonics Details	Phase Degrees	
DC	5.059	4.2%		
5	0	0.0%		
10	0	0.0%		
15	0	0.0%		
20	0	0.0%		
25	0	0.0%		
30	0	0.0%		
35	0	0.0%		
40	0	0.0%		
45	0	0.0%		
50	0	0.0%		
55	0	0.0%		
60	1	119.8	100.0%	0.9°
65	0	0.0%		
70	0	0.0%		
75	0	0.0%		
80	0	0.0%		

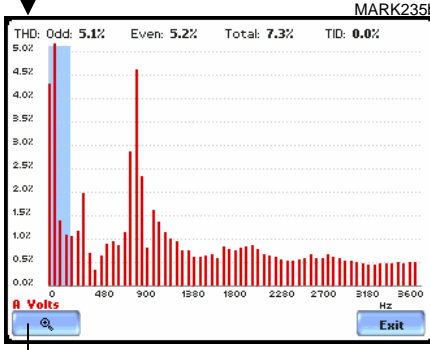

Hz	Volts	Harmonics Details	Phase Degrees	
60	119.8	100.0%		
900	15	5.418	4.5%	241.3°
DC	0	5.059	4.2%	90.0°
840	14	3.386	2.8%	39.8°
960	16	2.750	2.3%	80.9°
360	6	2.321	1.9%	46.4°
1080	18	1.910	1.6%	294.0°
120	2	1.647	1.4%	121.3°
1140	19	1.621	1.4%	170.8°
300	5	1.398	1.2%	190.7°
1200	20	1.352	1.1%	65.3°
780	13	1.350	1.1%	148.2°
180	3	1.300	1.1%	38.4°
240	4	1.243	1.0%	296.2°
1260	21	1.204	1.0%	337.9°
1320	22	1.126	0.9%	230.8°
660	11	1.116	0.9%	308.5°

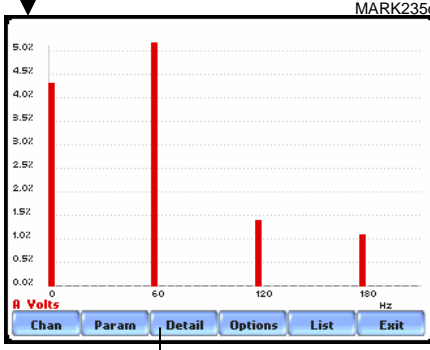

toggle between Normalized
and UnNormalized phase
values

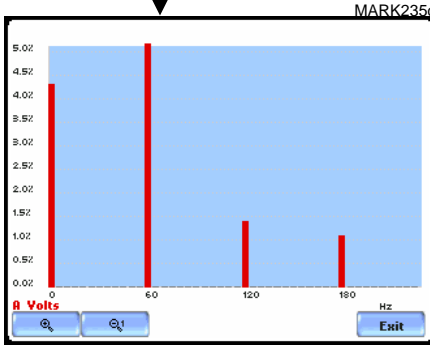

LEVEL 240 Phasor Display

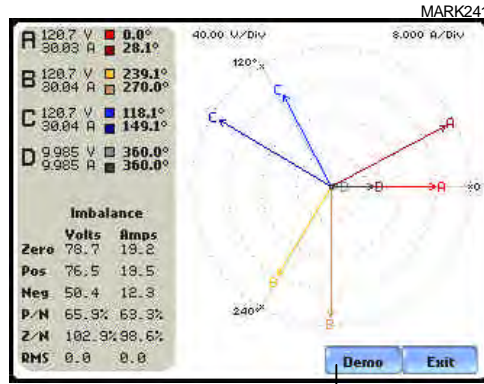

run demo to show rotating phasor relative to sine wave graph of 4 Wire Wye

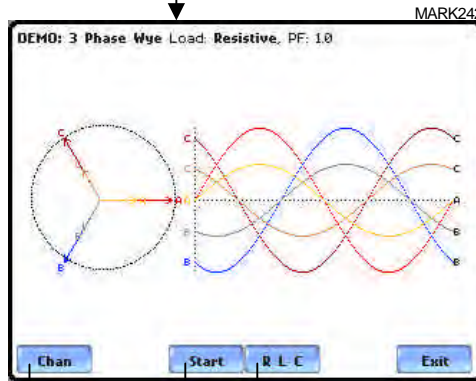

switch demo between Resistive, Inductive and Capacitive load effects

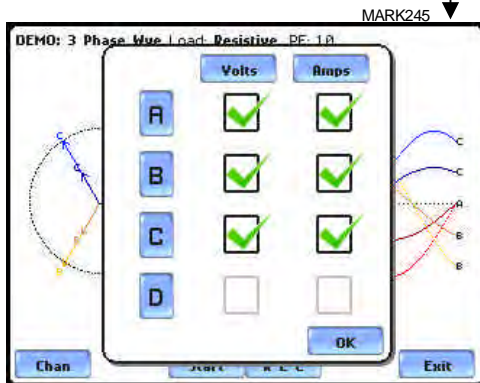

Start/Stop demo plot waveforms as rotate phasors

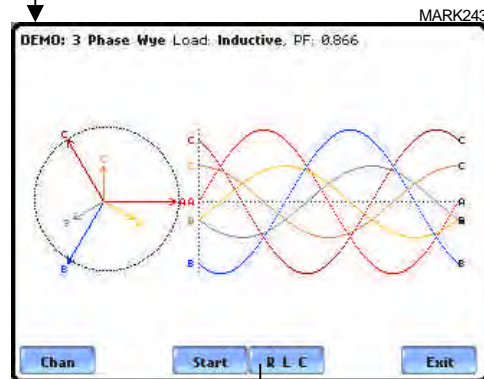

switch demo between Resistive, Inductive and Capacitive load effects

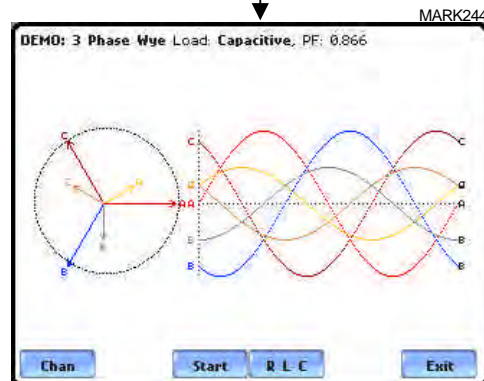

LEVEL 112 101 Advanced Options - Transient Limit

MARK112

MARK112_101

Channel A Channel B Channel C Channel D

Absolute Instantaneous Peak

Enable

Vpk 204.0 Vpk

Group A B C

Amps Next Cancel

MARK112

Advanced Options

The limits for capturing events are now set according to the monitoring mode that you selected. Press **Next** if you wish to continue with the default, or use the keys below to modify:

Transient Limit Characterizer Options

RMS Variation Limit Journal Limit

Waveform Capture Journal Interval

Prev Next Cancel

MARK112_102

Channels A B C Channel D

Absolute Instantaneous Peak

Enable

Vpk 204.0 Vpk

Group A B C

Amps Next Cancel

MARK112_104

Channel A Channel B Channel C Channel D

Threshold

Duration

Cycle-to-cycle Waveshape

Enable

Threshold: 12.00 Volts

Duration: 10.00 % of cycle

Group A B C

Amps Prev Next Cancel

MARK112_105

Channel A Channel B Channel C Channel D

Present Cycle Previous Cycle Difference

RMS

RMS Distortion Waveshape

Enable 8.400 Volts

Group A B C

Amps Prev Next Cancel

MARK112_107

Transient Pre/Post Cycle Setup:

Use Default: Set the same as RMS Variation Wave Snapshot Pre/Post Setting:

■ Pre-Trigger Cycles: 1 ■ Pre-Trigger Cycles: 2

■ Post-Trigger Cycles: 2 ■ Post-Trigger Cycles: 2

Prev Finish Cancel

MARK112_106

Transient Pre/Post Cycle Setup:

Use Default: Set the same as RMS Variation Wave Snapshot Pre/Post Setting:

■ Pre-Trigger Cycles: 1 ■ Pre-Trigger Cycles: 2

■ Post-Trigger Cycles: 2 ■ Post-Trigger Cycles: 2

Prev Finish Cancel

LEVEL 112_201

Advanced Options - RMS Variation Limit

MARK112

MARK112_201

Volts A Volts B Volts C Volts D V A-B V B-C V C-A

PRESENT VALUE: 120.7 V

RMS Variation Setup

High 132.0 V

Low 108.0 V

Very Low 12.00 V

Group A B C

% of Nominal

Next Cancel

Current Probe

Scale Factors

Circuit Type

Nominal Values

Mode of Operation

Monitoring Mode

Advanced Options

Memory Card

Advanced Options

The limits for capturing events are now set according to the monitoring mode that you selected. Press **Next** if you wish to continue with the default, or use the keys below to modify:

Transient Limit Characterizer Options

RMS Variation Limit Journal Limit

Waveform Capture Journal Interval

Prev Next Cancel

MARK112_202

Volts A B C Volts D Volts AB BC CA

PRESENT VALUE: A:120.7 B:120.7 C:120.7

RMS Variation Setup

High 132.0 V

Low 108.0 V

Very Low 12.00 V

Group A B C

% of Nominal

Next Cancel

MARK112_209

RMS Summary (Cycles):

Pre-Trigger: 6 In-Out Post: 6 Out-In Post: 6

Waveform Capture (Cycles, must be <= RMS):

Pre-Trigger: 2 Post-Trigger: 2 Enable

Prev Finish Cancel

MARK112_203

Volts A Volts B Volts C Volts D V A-B V B-C V C-A

PRESENT VALUE: 120.7 V

RMS Variation Setup

High 110.0 %

Low 90.00 %

Very Low 10.00 %

Group A B C

% of Nominal

Next Cancel

MARK112_204

Amps A Amps B Amps C Amps D

PRESENT VALUE: 244.9 A

RMS Variation Setup

High A

Low A

Very Low A

Group A B C

% of Nominal

Next Cancel

MARK112_205

Amps A Amps B Amps C Amps D

PRESENT VAL: 108_

1 2 3 +

4 5 6 x1000

7 8 9 Disabl

0 +/- Ok

Cancel

Next Cancel

MARK112_206

Amps A Amps B Amps C Amps D

PRESENT VALUE: 244.9 A

RMS Variation Setup

High 132.0 A

Low 108.0 A

Very Low 12.00 A

Group A B C

% of Nominal

Next Cancel

LEVEL 112 301 Advanced Options - Waveform Capture

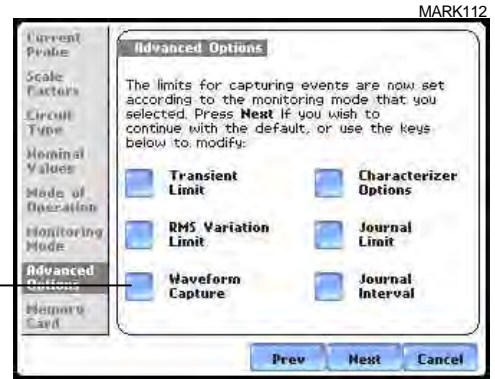
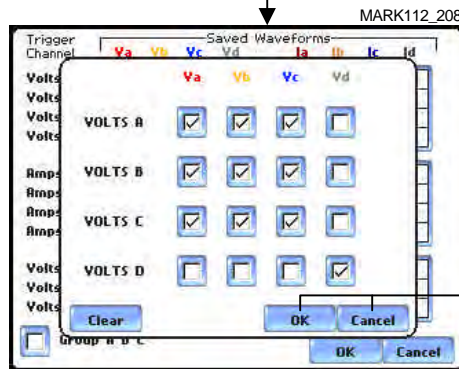
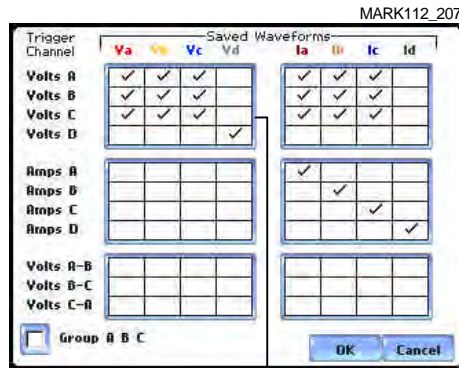

LEVEL 112 401 Advanced Options - Characterizer Options

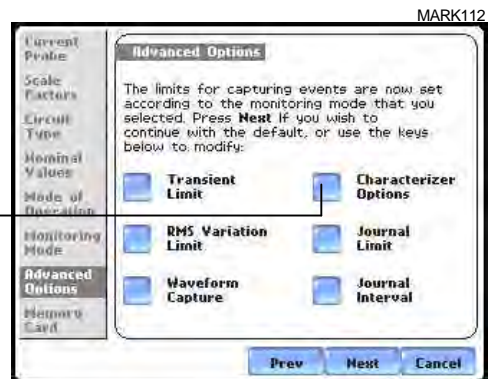
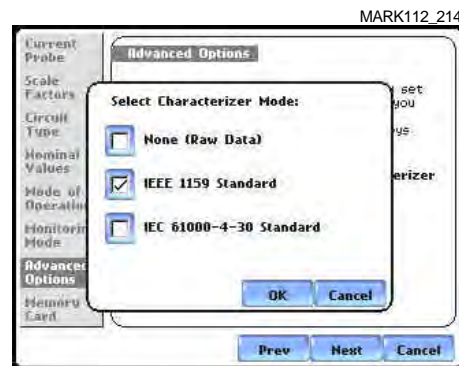

LEVEL 112 501 Advanced Options - Journal Limit

MARK112_301pg

MARK112

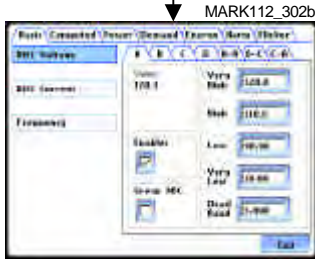

MARK112_302b

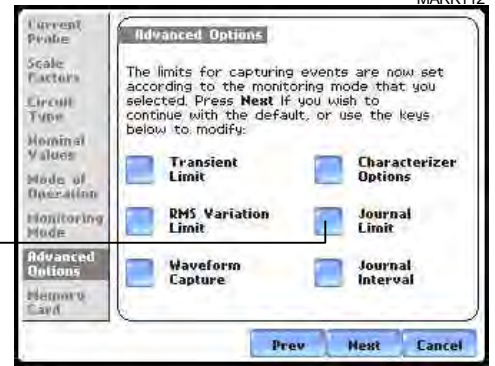

MARK112_311



MARK112_331



MARK112_312



MARK112_332



MARK112_313

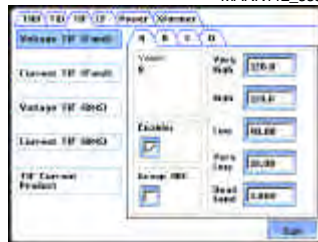

MARK112_333

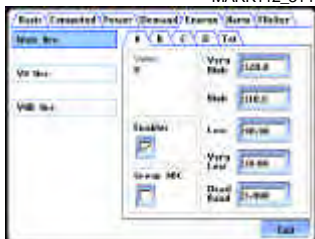

MARK112_314



MARK112_334

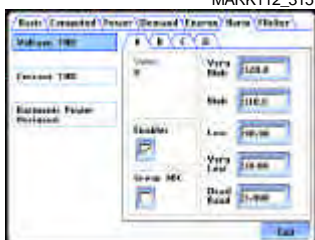

MARK112_315



MARK112_335

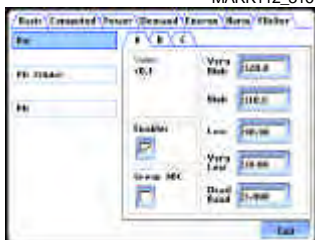

MARK112_316



MARK112_336

Level 112_601 Advanced Options - Journal Interval

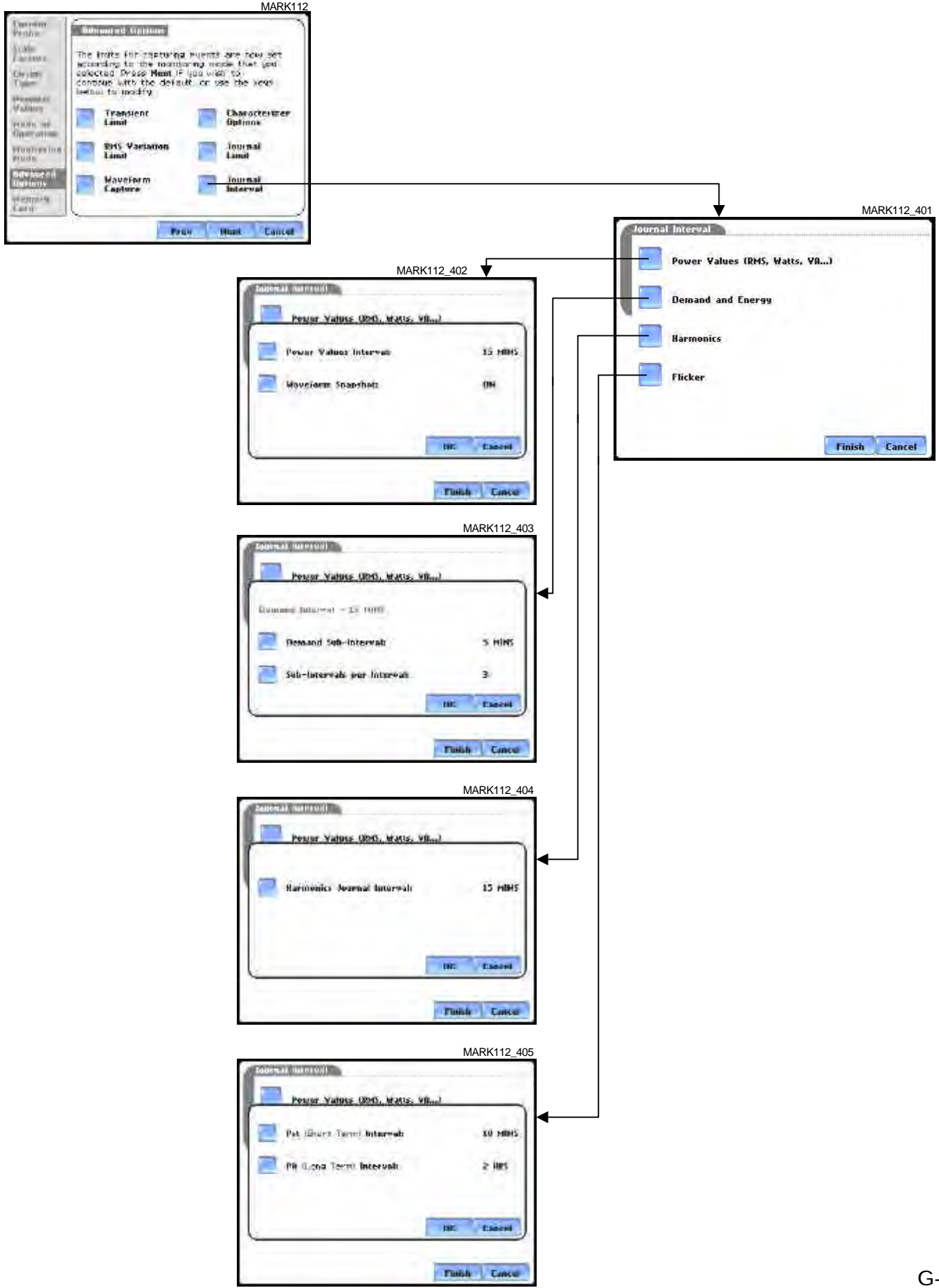

LEVEL 112 701

Advanced Options - EN50160 Options

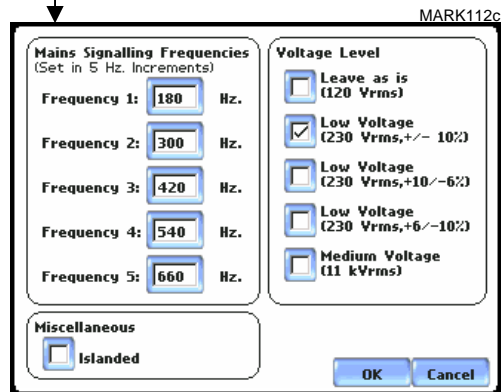
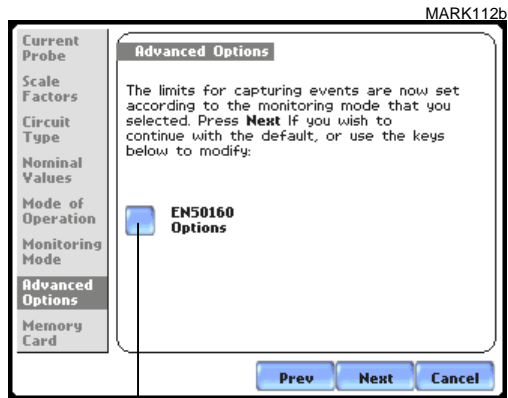

LEVEL 400 Events

PVISA124

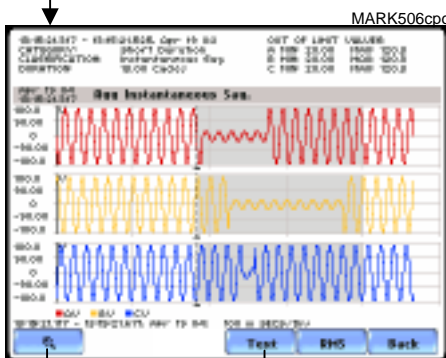
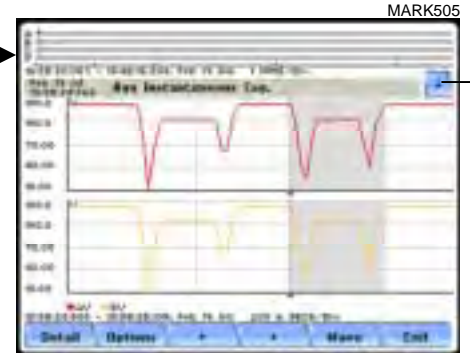
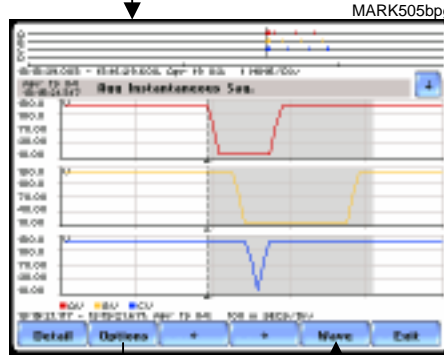
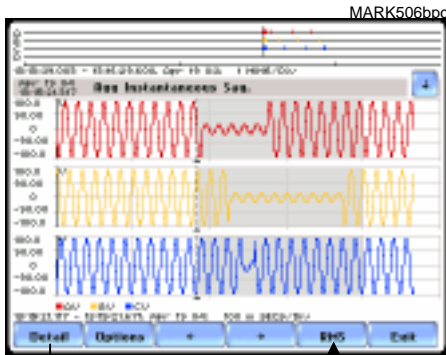
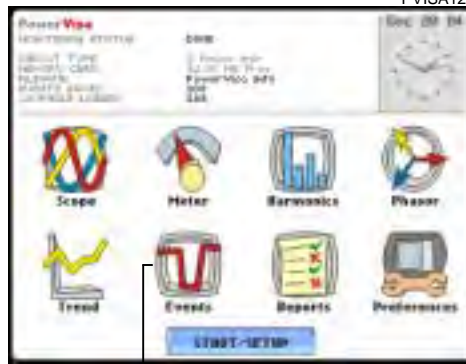

toggle between waveform and rms display

TO LEVEL 401



use scroll bar or up/down arrow keys to sort through event list, then press to select (highlight) desired event entry

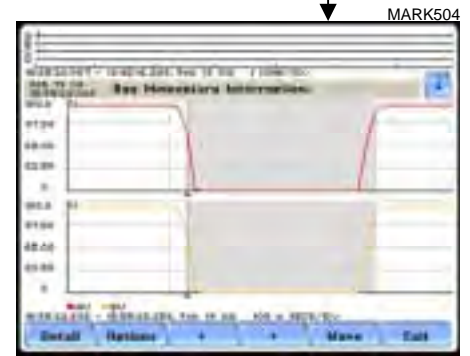
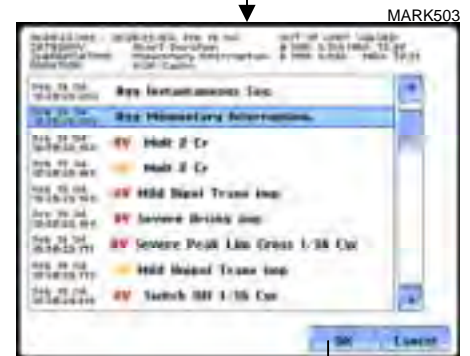
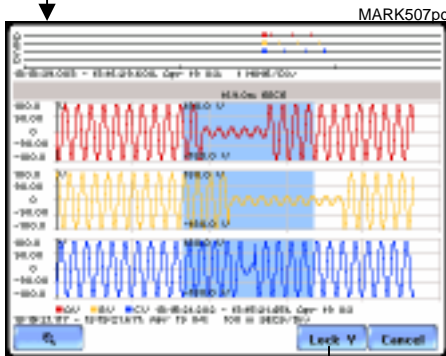

touch/drag blue zoom box to desired proportion

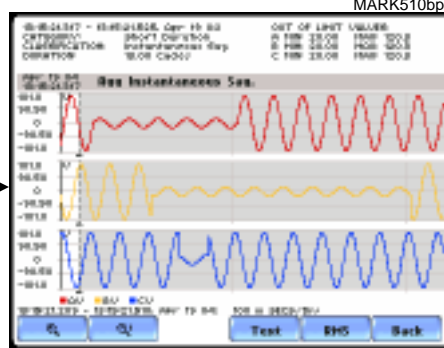
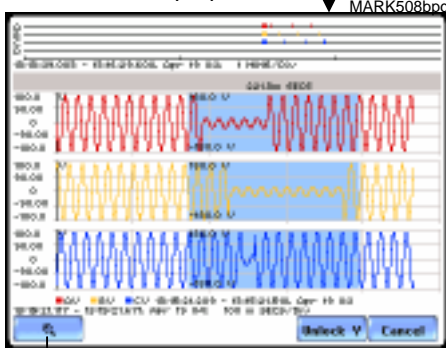

LEVEL 401

Event Options

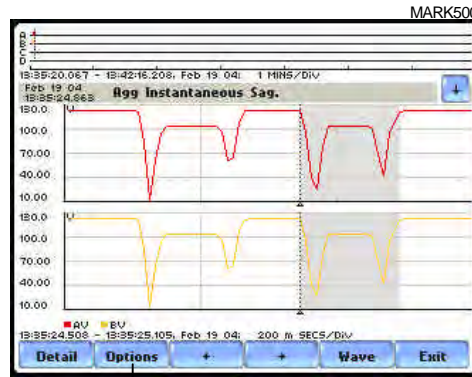

MARK511

Select Channels to Plot

Plot #1: RV Change

Plot #2: RV Change

Plot #3: Change

Plot #4: Change

OK Cancel

18:35:24.508 - 18:35:25.105, Feb. 19. 04; 200 m SECS/Div

Detail Options + + Wave Exit

MARK512

	VOLTS	AMPS	
A	<input checked="" type="checkbox"/>	<input type="checkbox"/>	A-B <input checked="" type="checkbox"/>
B	<input type="checkbox"/>	<input type="checkbox"/>	B-C <input type="checkbox"/>
C	<input type="checkbox"/>	<input type="checkbox"/>	C-R <input type="checkbox"/>
D	<input type="checkbox"/>	<input type="checkbox"/>	

Clear OK Cancel

18:35:24.508 - 18:35:25.105, Feb. 19. 04; 200 m SECS/Div

Detail Options + + RMS Exit

press Clear to reset all checkboxes

press Cancel to ignore changes and return to original plot

MARK513

Select Channels to Plot

Plot #1: RV, A-B Change

Plot #2: RV Change

Plot #3: Change

Plot #4: Change

OK Cancel

18:35:24.508 - 18:35:25.105, Feb. 19. 04; 200 m SECS/Div

Detail Options + + RMS Exit

LEVEL 430

Trend

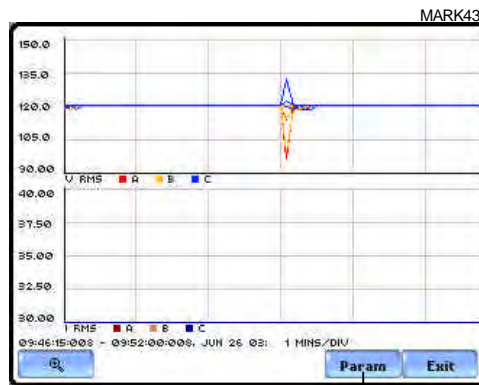

MARK432

Param 1	Param 2
Plot 01: V RMS A, B, C	
Plot 02: I RMS A, B, C	
Plot 03:	
Plot 04:	

Buttons: OK, Cancel, Param, Exit

MARK433PG

Advanced Parameters

- Standards List
- Distortion

Buttons: Disable, Cancel

MARK434

Param 1	Param 2
Plot 01: V RMS A, B, C	
Plot 02:	
Plot 03:	
Plot 04:	

Buttons: OK, Cancel, Param, Exit

MARK436

Basic | Computed | Power | Demand | Energy | Harm | Flicker

- RMS Voltage
- RMS Current
- Frequency

Buttons: Back, Cancel

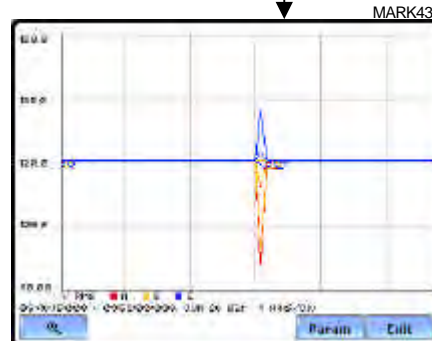
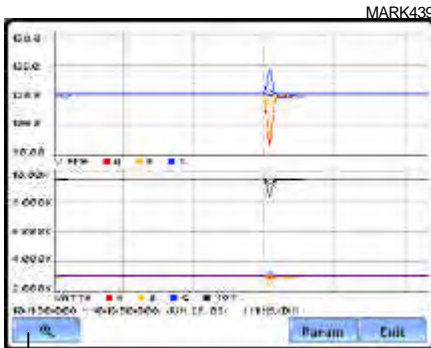

MARK437

Basic | Computed | Power | Demand | Energy | Harm | Flicker

- Active Power
- Apparent Power
- Reactive Power
- True Power Factor
- Displacement PF

Buttons: Back, Cancel

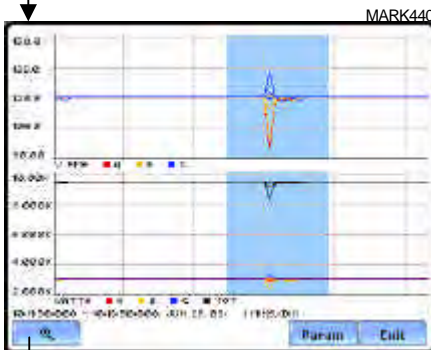

MARK438

Param 1	Param 2
Plot 01: V RMS A, B, C	
Plot 02: Watts A, B, C, Tot	
Plot 03:	
Plot 04:	

Buttons: OK, Cancel, Param, Exit

MARK437b

Basic | Computed | Power | Demand | Energy | Harm | Flicker

Active Power

- A
- B
- C
- D
- Tot

Buttons: Back, OK, Cancel, Exit

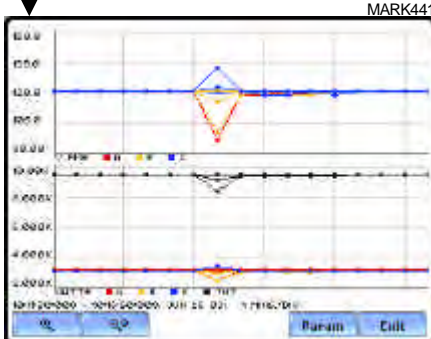

**LEVEL 470(a)
Reports – EN50160**

PVISA491

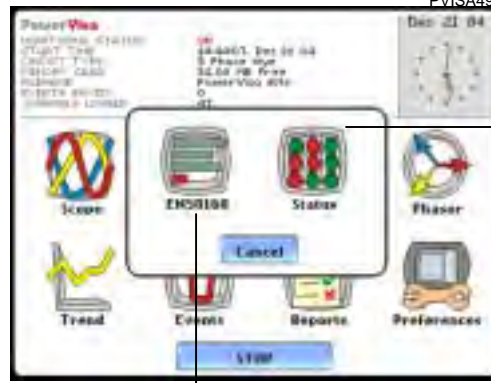

To Level 470(b)



MARK471

Evaluation Status	Evaluation Period	Compliance	Int5 Event Count	Trans. Event Count
Complete	05-05-03 12:00:00	Pass	0	0
Complete	05-20-03 12:00:00	Fail	5	1

MARK472

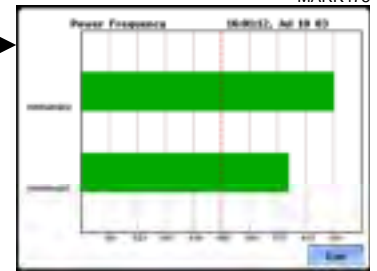

MARK478

Order	Phase A	Phase B	Phase C
2	0.00	0.00	0.00
3	0.00	0.00	0.00
4	0.00	0.00	0.00
5	0.00	0.00	0.00

MARK473

return to Home screen



MARK479

Transient Overvoltage	Count
180	100
220	100
140	100
200	200
250	0

MARK474

Power Frequency - V Unbalance (U2-U3)	Min	Max
	49.99	50.00

MARK476



MARK480

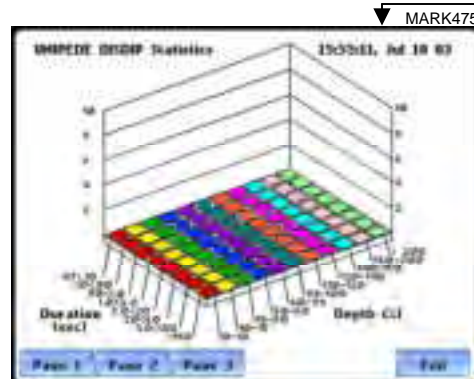

MARK475

Harmonic x	Phase B	Phase B	Phase C
THD	0.00	0.00	0.00
2	1.00	0.00	0.00
3	1.00	0.00	0.00
4	1.00	0.00	0.00
5	1.00	0.00	0.00

MARK477

until Harm #25

**LEVEL 470(b)
Reports – PQ Status**

MARK491b

RMS Voltage	RMS Current	V RMS Imbalance
A: 120.3	A: 30.07	A: 0
B: 120.3	B: 30.07	B: 0
C: 120.3	C: 30.07	C: 0
True Power Factor	Harmonics	X Transformer
A: 0.982	A: 4.276	A: 1.000
B: 0.983	B: 4.159	B: 1.000
C: 0.983	C: 4.159	C: 1.000
Voltage THD (%)	Current THD (%)	Negative Sequen...
A: 0.055	A: 0.052	Total: 0.285
B: 0.050	B: 0.051	
C: 0.050	C: 0.052	

Options Exit

return to Home screen

MARK602

Preset Motor Quality

Load Present

Panel Size:

Small (14x11)

Medium (12x1)

Large (12x2)

OK Cancel

MARK609

V RMS Imbalance

View Graph

View Limits

Edit Panel

Exit

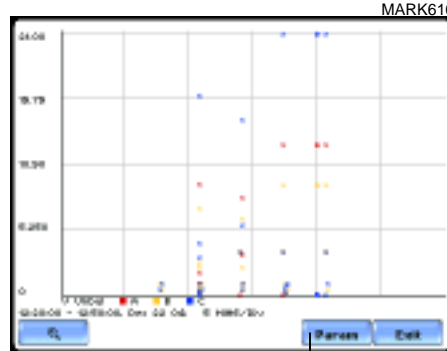

MARK603

Select Preset:

Standard PQ

EN50160

Meter Quality

OK Cancel

MARK611

Pares 1 Pares 2

Plot 01: V Imbal A, B, C

Plot 02:

Plot 03:

Plot 04:

OK Cancel

MARK612

V RMS Imbalance Limits

	V-High	High	Low	V-Low
A	2.000	1.000	---	---
B	2.000	1.000	---	---
C	2.000	1.000	---	---
Volts	Max	---	---	---

OK Cancel

MARK433pg

Journal Categories

Standard List

Distortion

Storable Cancel

MARK613

This Tab will Store:

Metered Data

Status (See, Swell, etc)

Cancel

MARK615

Select Parameters:

See

Swell

Transient

Cancel