

# LM20145

## 5A, PowerWise® Adjustable Frequency Synchronous Buck Regulator

### General Description

The LM20145 is a full featured adjustable frequency synchronous buck regulator capable of delivering up to 5A of continuous output current. The current mode control loop can be compensated to be stable with virtually any type of output capacitor. For most cases, compensating the device only requires two external components, providing maximum flexibility and ease of use. The device is optimized to work over the input voltage range of 2.95V to 5.5V making it suited for a wide variety of low voltage systems.

The device features internal over voltage protection (OVP) and over current protection (OCP) circuits for increased system reliability. A precision enable pin and integrated UVLO allows the turn-on of the device to be tightly controlled and sequenced. Start-up inrush currents are limited by both an internally fixed and externally adjustable Soft-Start circuit. Fault detection and supply sequencing is possible with the integrated power good circuit.

The LM20145 is designed to work well in multi-rail power supply architectures. The output voltage of the device can be configured to track a higher voltage rail using the SS/TRK pin. If the output of the LM20145 is pre-biased at startup it will not sink current to pull the output low until the internal soft-start ramp exceeds the voltage at the feedback pin.

The frequency of this device can be adjusted from 250 kHz to 750 kHz by connecting an external resistor from the RT pin to ground.

The LM20145 is offered in a 16-pin eTSSOP package with an exposed pad that can be soldered to the PCB, eliminating the need for bulky heatsinks.

### Features

- Input voltage range 2.95V to 5.5V
- Accurate current limit minimizes inductor size
- 97% peak efficiency
- Adjustable switching frequency (250 kHz to 750 kHz)
- 32 mΩ integrated FET switches
- Starts up into pre-biased loads
- Output voltage tracking
- Peak current mode control
- Adjustable output voltage down to 0.8V
- Adjustable Soft-Start with external capacitor
- Precision enable pin with hysteresis
- Integrated OVP, UVLO, power good and thermal shutdown
- eTSSOP-16 exposed pad package

### Applications

- Simple to design, high efficiency point of load regulation from a 5V or 3.3V bus
- High Performance DSPs, FPGAs, ASICs and microprocessors
- Broadband, Networking and Optical Communications Infrastructure

### Typical Application Circuit

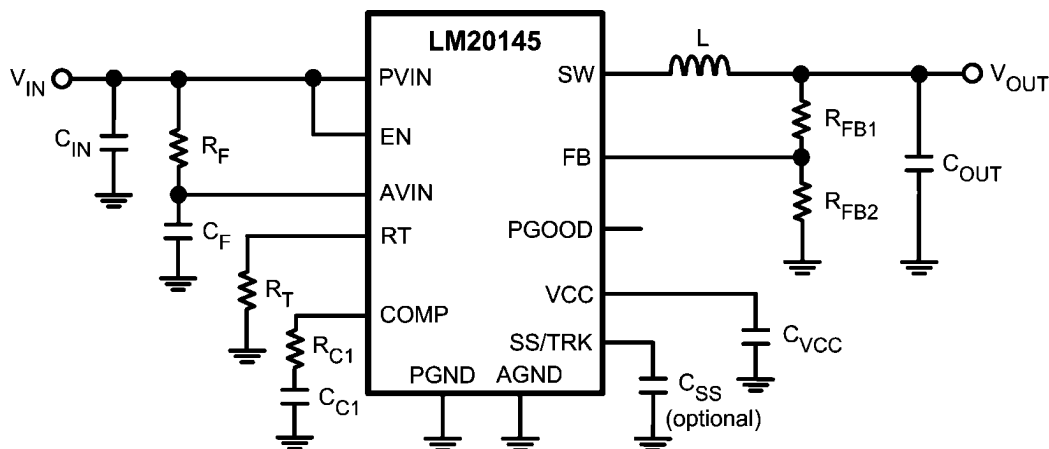

30030701

## Connection Diagram

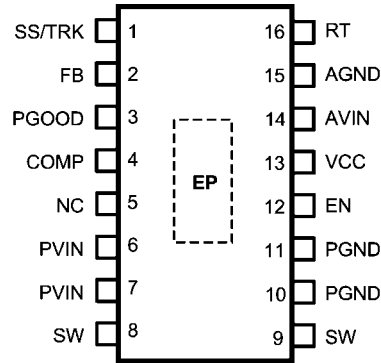

Top View  
eTSSOP-16 Package

30030702

## Ordering Information

Order Number	Package Type	NSC Package Drawing	Package Marking	Supplied As
LM20145MH	eTSSOP-16	MXA16A	20145MH	92 Units of Rail
LM20145MHE				250 Units of Tape and Reel
LM20145MHX				2500 Units of Tape and Reel

## Pin Descriptions

Pin #	Name	Description
1	SS/TRK	Soft-Start or Tracking control input. An internal 5 $\mu$ A current source charges an external capacitor to set the Soft-Start ramp rate. If driven by a external source less than 800 mV, this pin overrides the internal reference that sets the output voltage. If left open, an internal 1ms Soft-Start ramp is activated.
2	FB	Feedback input to the error amplifier from the regulated output. This pin is connected to the inverting input of the internal transconductance error amplifier. An 800 mV reference connected to the non-inverting input of the error amplifier sets the closed loop regulation voltage at the FB pin.
3	PGOOD	Power good output signal. Open drain output indicating the output voltage is regulating within tolerance. A pull-up resistor of 10 k $\Omega$ to 100 k $\Omega$ is recommend for most applications.
4	COMP	External compensation pin. Connect a resistor and capacitor to this pin to compensate the device.
5	NC	These pins must be connected to GND to ensure proper operation
6,7	PVIN	Input voltage to the power switches inside the device. These pins should be connected together at the device. A low ESR capacitor should be placed near these pins to stabilize the input voltage.
8,9	SW	Switch pin. The PWM output of the internal power switches.
10,11	PGND	Power ground pin for the internal power switches.
12	EN	Precision enable input for the device. An external voltage divider can be used to set the device turn-on threshold. If not used the EN pin should be connected to PVIN.
13	VCC	Internal 2.7V sub-regulator. This pin should be bypassed with a 1 $\mu$ F ceramic capacitor.
14	AVIN	Analog input supply that generates the internal bias. Must be connected to VIN through a low pass RC filter.
15	AGND	Quiet analog ground for the internal bias circuitry.
16	RT	Frequency adjust pin. Connecting a resistor on this pin to ground will set the oscillator frequency.
EP	Exposed Pad	Exposed metal pad on the underside of the package with a weak electrical connection to ground. It is recommended to connect this pad to the PC board ground plane in order to improve heat dissipation.

**Absolute Maximum Ratings** (Note 1)

If Military/Aerospace specified devices are required, please contact the National Semiconductor Sales Office/Distributors for availability and specifications.

Voltages from the indicated pins to GND	
AVIN, PVIN, EN, PGOOD, SS/TRK, COMP, FB, RT	-0.3V to +6V
Storage Temperature	-65°C to 150°C
Junction Temperature	150°C

Power Dissipation (Note 2)	2.6W
Lead Temperature (Soldering, 10 sec)	260°C
Minimum ESD Rating (Note 3)	±2kV

**Operating Ratings**

PVIN, AVIN to GND	2.95V to 5.5V
Junction Temperature	-40°C to +125°C

**Electrical Characteristics**

Unless otherwise stated, the following conditions apply: AVIN = PVIN = VIN = 5V.

Limits in standard type are for  $T_J = 25^\circ\text{C}$  only, limits in bold face type apply over the junction temperature ( $T_J$ ) range of  $-40^\circ\text{C}$  to  $+125^\circ\text{C}$ . Minimum and Maximum limits are guaranteed through test, design, or statistical correlation. Typical values represent the most likely parametric norm at  $T_J = 25^\circ\text{C}$ , and are provided for reference purposes only.

Symbol	Parameter	Conditions	Min	Typ	Max	Unit
$V_{FB}$	Feedback pin voltage	$V_{IN} = 2.95\text{V to }5.5\text{V}$	<b>0.788</b>	0.8	<b>0.812</b>	V
$\Delta V_{OUT}/\Delta I_{OUT}$	Load Regulation	$I_{OUT} = 100\text{ mA to }5\text{A}$		0.08		%/A
$I_{CL}$	Switch Current Limit Threshold	$V_{IN} = 3.3\text{V}$	<b>6.7</b>	7.4	<b>8.1</b>	A
$R_{DS\_ON}$	High-Side Switch On Resistance	$I_{SW} = 3.5\text{A}$		36	<b>55</b>	m $\Omega$
$R_{DS\_ON}$	Low-Side Switch On Resistance	$I_{SW} = 3.5\text{A}$		32	<b>52</b>	m $\Omega$
$I_Q$	Operating Quiescent Current	Non-switching, $V_{FB} = V_{COMP}$		3.5	<b>6</b>	mA
$I_{SD}$	Shutdown Quiescent current	$V_{EN} = 0\text{V}$		90	<b>180</b>	$\mu\text{A}$
$V_{UVLO}$	VIN Under Voltage Lockout	Rising $V_{IN}$	<b>2.45</b>	2.7	<b>2.95</b>	V
$V_{UVLO\_HYS}$	VIN Under Voltage Lockout Hysteresis	Falling $V_{IN}$		45	<b>100</b>	mV
$V_{VCC}$	VCC Voltage	$I_{VCC} = 0\ \mu\text{A}$	<b>2.45</b>	2.7	<b>2.95</b>	V
$I_{SS}$	Soft-Start Pin Source Current	$V_{SS/TRK} = 0\text{V}$	<b>2</b>	4.5	<b>7</b>	$\mu\text{A}$
$V_{TRACK}$	SS/TRK Accuracy, $V_{SS} - V_{FB}$	$V_{SS/TRK} = 0.4\text{V}$	<b>-10</b>	3	<b>15</b>	mV
<b>Oscillator</b>						
$F_{OSCH}$	Oscillator Frequency	$R_T = 49.9\text{ k}\Omega$	<b>675</b>	750	<b>825</b>	kHz
$F_{OSCL}$	Oscillator Frequency	$R_T = 249\text{ k}\Omega$	<b>225</b>	260	<b>290</b>	kHz
$DC_{MAX}$	Maximum Duty Cycle	$I_{LOAD} = 0\text{A}$		85		%
$T_{ON\_TIME}$	Minimum On Time			100		ns
$T_{CL\_BLANK}$	Current Sense Blanking Time	After Rising $V_{SW}$		80		ns
<b>Error Amplifier and Modulator</b>						
$I_{FB}$	Feedback pin bias current	$V_{FB} = 0.8\text{V}$		1	<b>100</b>	nA
$I_{COMP\_SRC}$	COMP Output Source Current	$V_{FB} = V_{COMP} = 0.6\text{V}$	<b>80</b>	100		$\mu\text{A}$
$I_{COMP\_SNK}$	COMP Output Sink Current	$V_{FB} = 1.0\text{V}, V_{COMP} = 0.6\text{V}$	<b>80</b>	100		$\mu\text{A}$
Gm	Error Amplifier Transconductance	$I_{COMP} = \pm 50\ \mu\text{A}$	<b>450</b>	510	<b>600</b>	$\mu\text{mho}$
$A_{VOL}$	Error Amplifier Voltage Gain			2000		V/V
<b>Power Good</b>						
$V_{OVP}$	Over Voltage Protection Rising Threshold	With respect to $V_{FB}$	<b>105</b>	108	<b>111</b>	%
$V_{OVP\_HYS}$	Over Voltage Protection Hysteresis			2	<b>3</b>	%
$V_{PGTH}$	PGOOD Rising Threshold	With respect to $V_{FB}$	<b>92</b>	94	<b>96</b>	%
$V_{PGHYS}$	PGOOD Falling Hysteresis			2	<b>3</b>	%
$T_{PGOOD}$	PGOOD deglitch time			16		$\mu\text{s}$
$I_{OL}$	PGOOD Low Sink Current	$V_{PGOOD} = 0.4\text{V}$	<b>0.6</b>	1		mA
$I_{OH}$	PGOOD High Leakage Current	$V_{PGOOD} = 5\text{V}$		5	<b>100</b>	nA

Symbol	Parameter	Conditions	Min	Typ	Max	Unit
<b>Enable</b>						
$V_{IH\_EN}$	EN Pin turn-on Threshold	$V_{EN}$ Rising	1.08	1.18	1.28	V
$V_{EN\_HYS}$	EN Pin Hysteresis			66		mV
<b>Thermal Shutdown</b>						
$T_{SD}$	Thermal Shutdown			160		°C
$T_{SD\_HYS}$	Thermal Shutdown Hysteresis			10		°C
<b>Thermal Resistance</b>						
$\theta_{JA}$	Junction to Ambient			38		°C/W

**Note 1:** Absolute Maximum Ratings indicate limits beyond which damage to the device may occur. Operating Ratings indicate conditions for which the device is intended to be functional, but do not guarantee specific performance limits. For guaranteed specifications and test conditions, see the Electrical Characteristics.

**Note 2:** The maximum allowable power dissipation is a function of the maximum junction temperature,  $T_{J\_MAX}$ , the junctions-to-ambient thermal resistance,  $\theta_{JA}$ , and the ambient temperature,  $T_A$ . The maximum allowable power dissipation at any ambient temperature is calculated using:  $P_{D\_MAX} = (T_{J\_MAX} - T_A)/\theta_{JA}$ . The maximum power dissipations of 2.6W is determined using  $T_A = 25^\circ\text{C}$ ,  $\theta_{JA} = 38^\circ\text{C/W}$ , and  $T_{J\_MAX} = 125^\circ\text{C}$ .

**Note 3:** The human body model is a 100 pF capacitor discharged through a 1.5 kΩ resistor to each pin.

**Typical Performance Characteristics** Unless otherwise specified:  $C_{IN} = C_{OUT} = 100 \mu\text{F}$ ,  $L = 1.5 \mu\text{H}$  (Coilcraft MSS1038),  $V_{IN} = 5\text{V}$ ,  $V_{OUT} = 1.2\text{V}$ ,  $R_{LOAD} = 1.2\Omega$ ,  $f_{SW} = 500 \text{ kHz}$ ,  $T_A = 25^\circ\text{C}$  for efficiency curves, loop gain plots and waveforms, and  $T_J = 25^\circ\text{C}$  for all others.

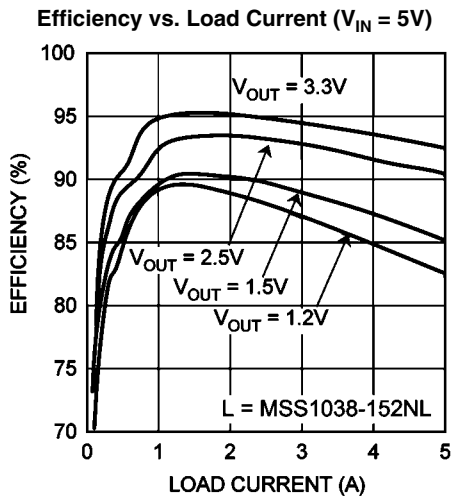

30030731

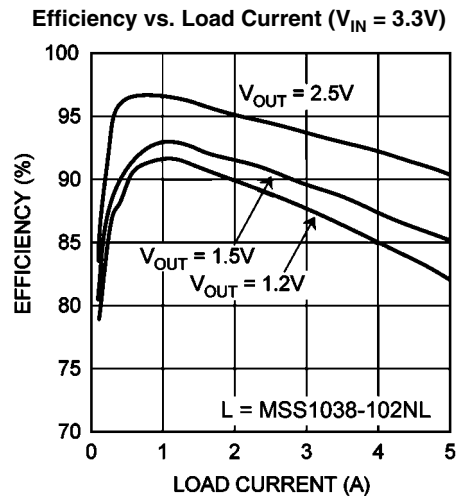

30030730

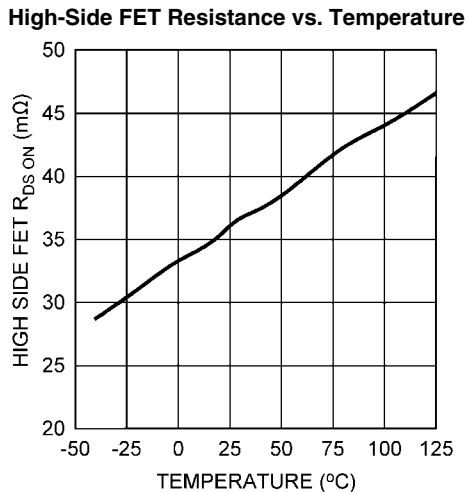

30030757

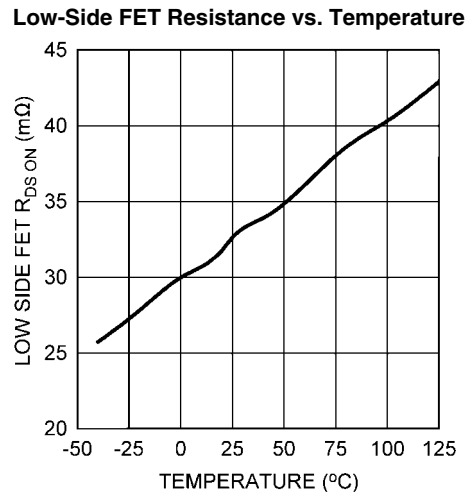

30030758

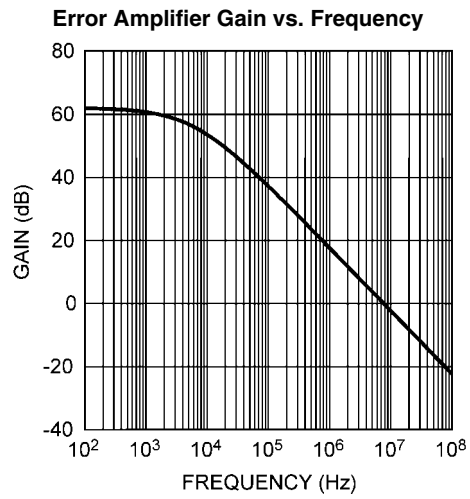

30030736

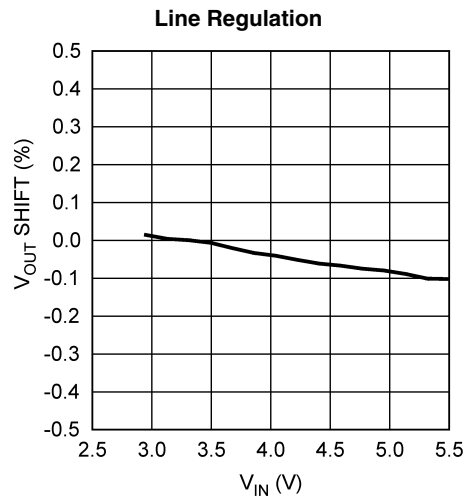

30030737

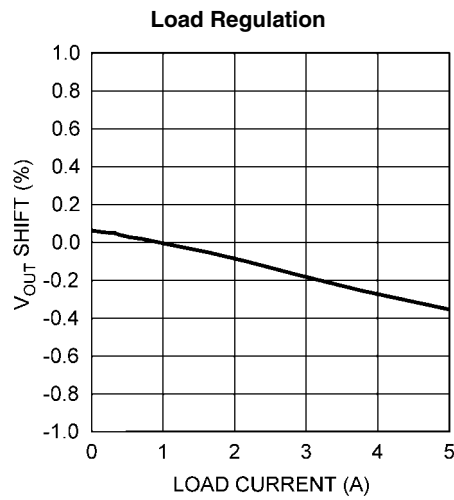

30030738

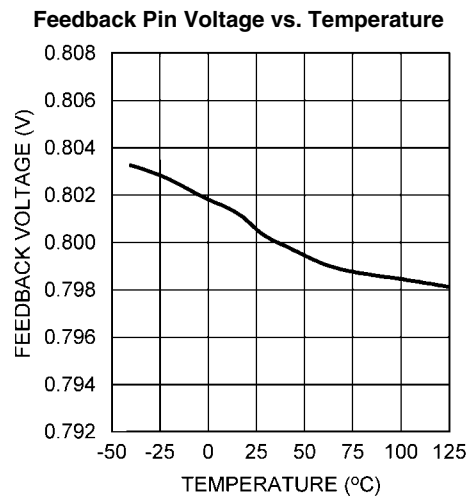

30030751

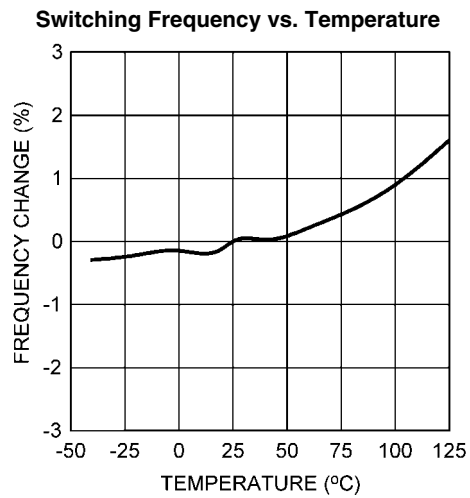

30030739

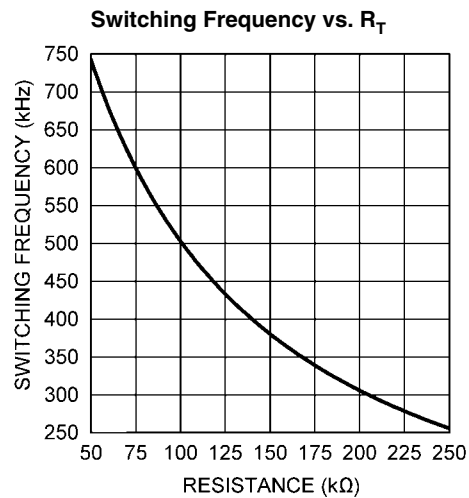

30030750

**Quiescent Current vs.  $V_{IN}$  (Not Switching)**

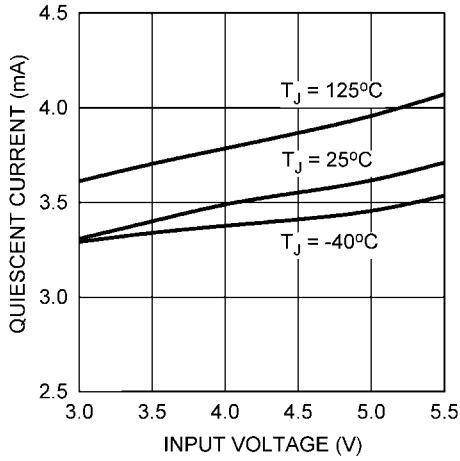

30030740

**Shutdown Current vs. Temperature**

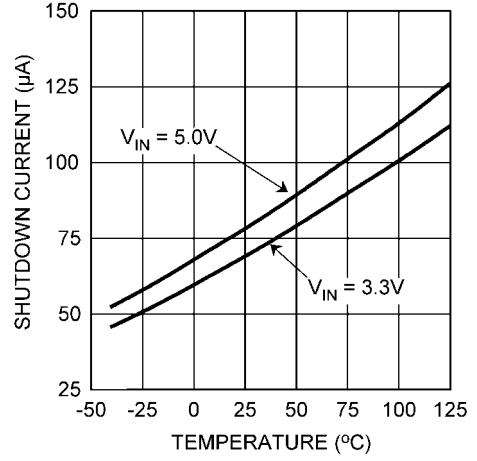

30030741

**Enable Threshold vs. Temperature**

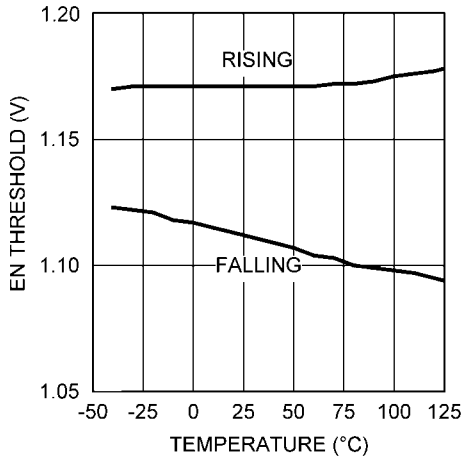

30030728

**UVLO Threshold vs. Temperature**

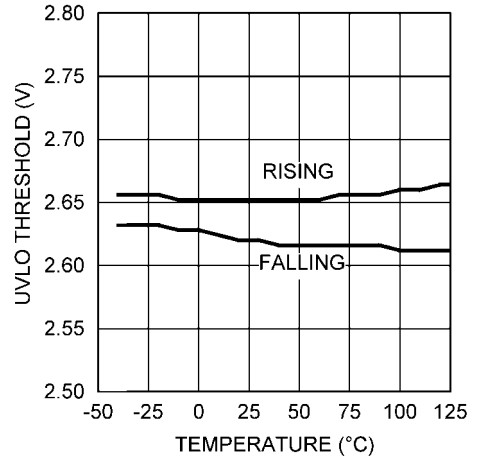

30030745

**Peak Current Limit vs. Temperature**

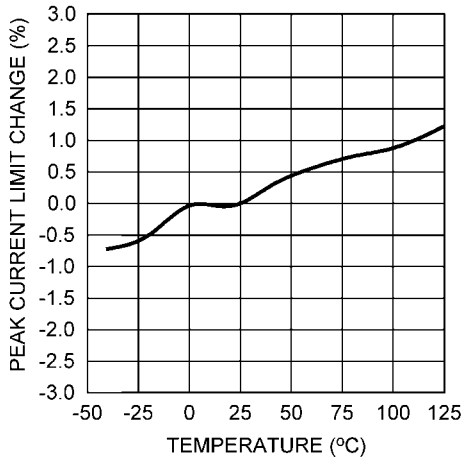

30030742

**Peak Current Limit vs.  $V_{OUT}$**

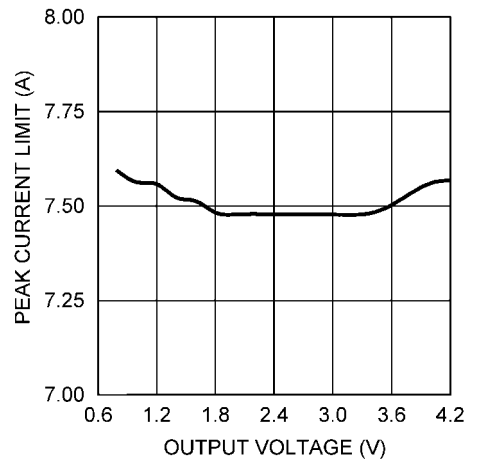

30030754

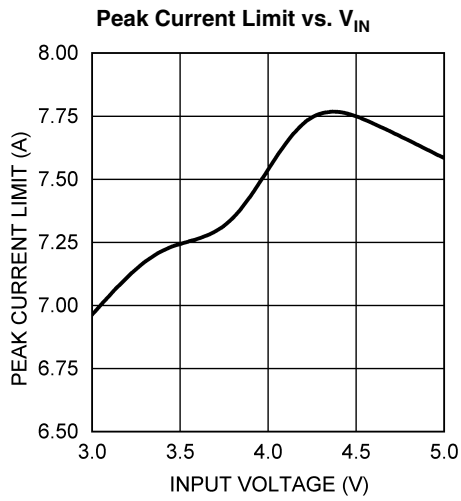

30030755

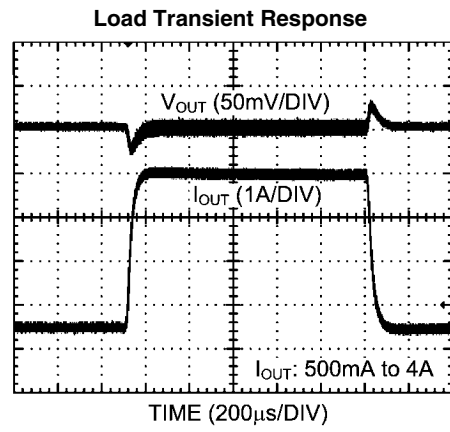

30030734

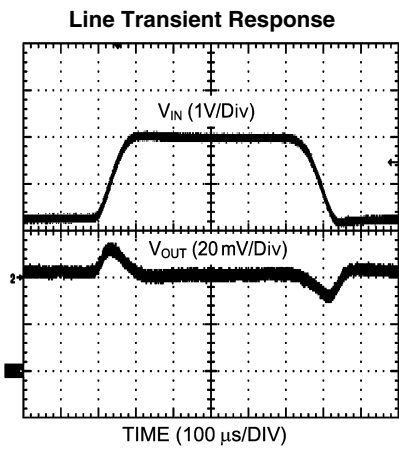

30030743

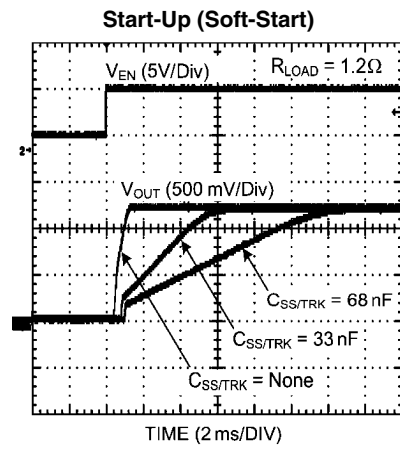

30030744

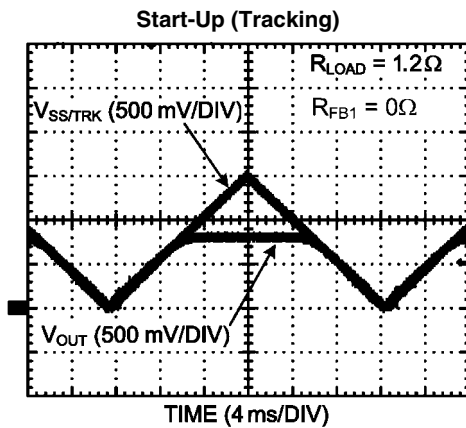

30030733

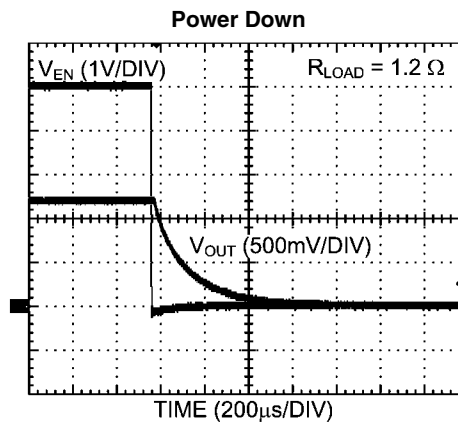

30030732

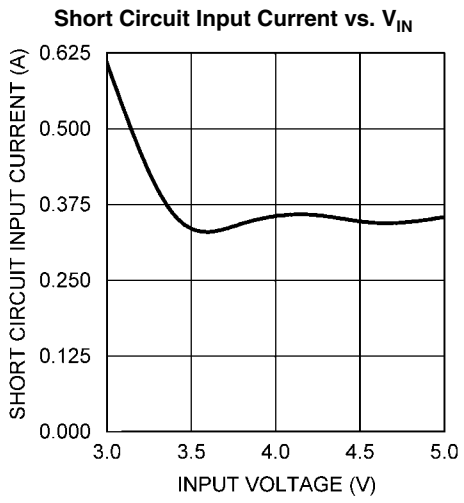

30030756

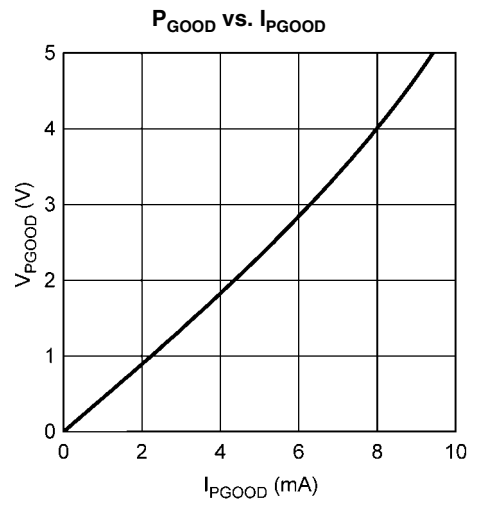

30030727



# Block Diagram

LM20145

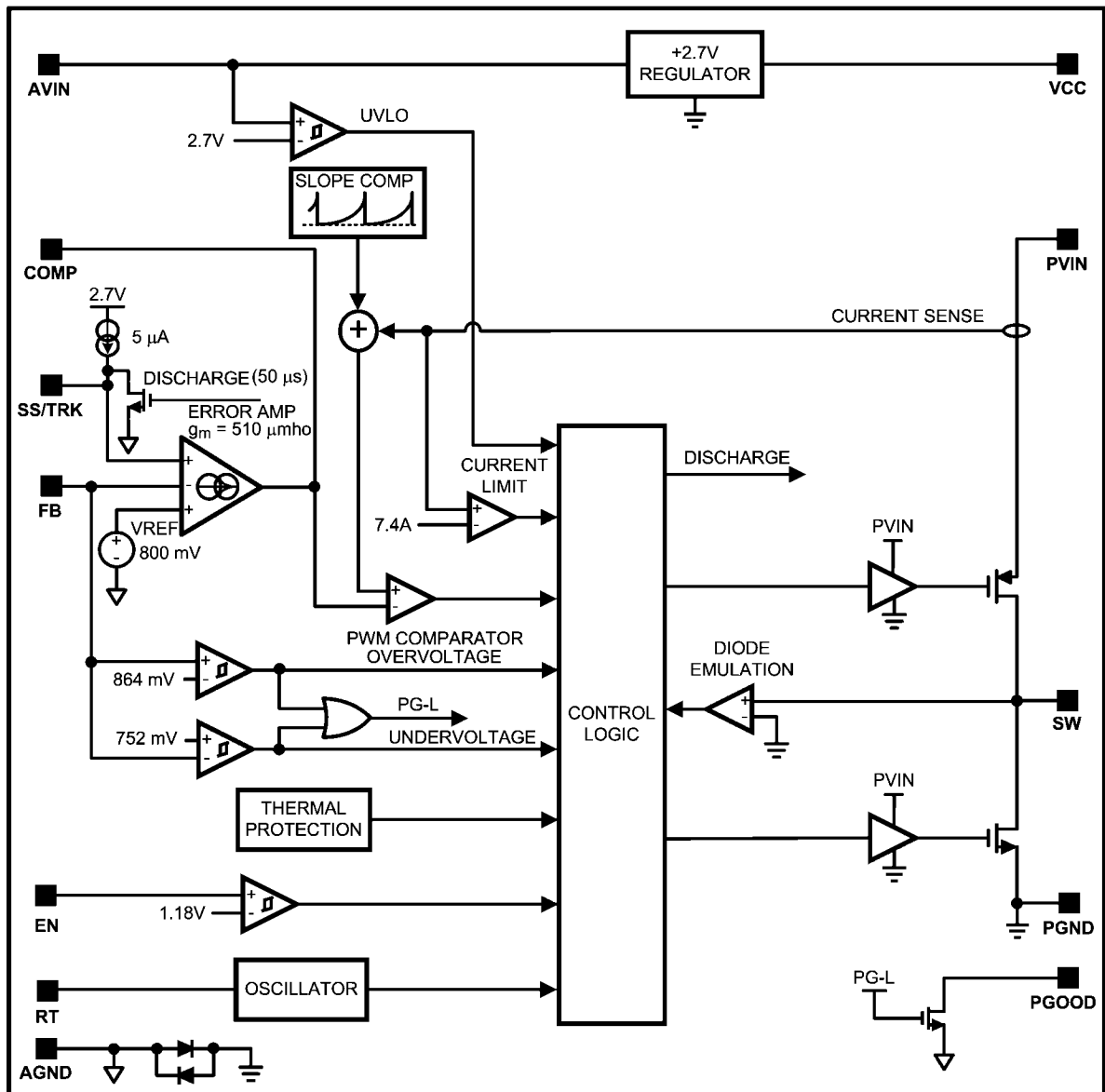

30030703

## Operation Description

### GENERAL

The LM20145 switching regulator features all of the functions necessary to implement an efficient low voltage buck regulator using a minimum number of external components. This easy to use regulator features two integrated switches and is capable of supplying up to 5A of continuous output current. The regulator utilizes peak current mode control with nonlinear slope compensation to optimize stability and transient response over the entire output voltage range. Peak current mode control also provides inherent line feed-forward, cycle-by-cycle current limiting and easy loop compensation. The switching frequency can be varied from 250 kHz to 750 kHz. The device can operate at high switching frequency allowing use of a small inductor while still achieving high efficiency. The precision internal voltage reference allows the output to be set as low as 0.8V. Fault protection features include: current limiting, thermal shutdown, over voltage protection, and shutdown capability. The device is available in the eTSSOP-16 package featuring an exposed pad to aid thermal dissipation. The LM20145 can be used in numerous applications to efficiently step-down from a 5V or 3.3V bus. The typical application circuit for the LM20145 is shown in *Figure 2* in the design guide.

### PRECISION ENABLE

The enable (EN) pin allows the output of the device to be enabled or disabled with an external control signal. This pin is a precision analog input that enables the device when the voltage exceeds 1.18V (typical). The EN pin has 66 mV of hysteresis and will disable the output when the enable voltage falls below 1.11V (typical). If the EN pin is not used, it should be connected to VIN. Since the enable pin has a precise turn-on threshold it can be used along with an external resistor divider network from VIN to configure the device to turn-on at a precise input voltage. The precision enable circuitry will remain active even when the device is disabled.

### PEAK CURRENT MODE CONTROL

In most cases, the peak current mode control architecture used in the LM20145 only requires two external components to achieve a stable design. The compensation can be selected to accommodate any capacitor type or value. The external compensation also allows the user to set the crossover frequency and optimize the transient performance of the device.

For duty cycles above 50% all current mode control buck converters require the addition of an artificial ramp to avoid sub-harmonic oscillation. This artificial linear ramp is commonly referred to as slope compensation. What makes the LM20145 unique is the amount of slope compensation will change depending on the output voltage. When operating at high output voltages the device will have more slope compensation than when operating at lower output voltages. This is accomplished in the LM20145 by using a non-linear parabolic ramp for the slope compensation. The parabolic slope compensation of the LM20145 is much better than the traditional linear slope compensation because it optimizes the stability of the device over the entire output voltage range.

### CURRENT LIMIT

The precise current limit of the LM20123 is set at the factory to be within 10% over the entire operating temperature range. This enables the device to operate with smaller inductors that have lower saturation currents. When the peak inductor current reaches the current limit threshold, an over current event is triggered and the internal high-side FET turns off and the

low-side FET turns on allowing the inductor current to ramp down until the next switching cycle. For each sequential over-current event, the reference voltage is decremented and PWM pulses are skipped resulting in a current limit that does not aggressively fold back for brief over-current events, while at the same time providing frequency and voltage foldback protection during hard short circuit conditions.

### SOFT-START AND VOLTAGE TRACKING

The SS/TRK pin is a dual function pin that can be used to set the start up time or track an external voltage source. The start up or Soft-Start time can be adjusted by connecting a capacitor from the SS/TRK pin to ground. The Soft-Start feature allows the regulator output to gradually reach the steady state operating point, thus reducing stresses on the input supply and controlling start up current. If no Soft-Start capacitor is used the device defaults to the internal Soft-Start circuitry resulting in a start up time of approximately 1 ms. For applications that require a monotonic start up or utilize the PGOOD pin, an external Soft-Start capacitor is recommended. The SS/TRK pin can also be set to track an external voltage source. The tracking behavior can be adjusted by two external resistors connected to the SS/TRK pin as shown in *Figure 7* in the design guide.

### PRE-BIAS START UP CAPABILITY

The LM20145 is in a pre-biased state when the device starts up with an output voltage greater than zero. This often occurs in many multi-rail applications such as when powering an FPGA, ASIC, or DSP. In these applications the output can be pre-biased through parasitic conduction paths from one supply rail to another. Even though the LM20145 is a synchronous converter it will not pull the output low when a prebias condition exists. During start up the LM20145 will not sink current until the Soft-Start voltage exceeds the voltage on the FB pin. Since the device can not sink current it protects the load from damage that might otherwise occur if current is conducted through the parasitic paths of the load.

### POWER GOOD AND OVER VOLTAGE FAULT HANDLING

The LM20145 has built in under and over voltage comparators that control the power switches. Whenever there is an excursion in output voltage above the set OVP threshold, the part will terminate the present on-pulse, turn-on the low-side FET, and pull the PGOOD pin low. The low-side FET will remain on until either the FB voltage falls back into regulation or the zero cross detection is triggered which in turn tri-states the FETs. If the output reaches the UVP threshold the part will continue switching and the PGOOD pin will be asserted and go low. Typical values for the PGOOD resistor are on the order of 100 k $\Omega$  or less. To avoid false tripping during transient glitches the PGOOD pin has 16  $\mu$ s of built in deglitch time to both rising and falling edges.

### UVLO

The LM20145 has a built-in under-voltage lockout protection circuit that keeps the device from switching until the input voltage reaches 2.7V (typical). The UVLO threshold has 45 mV of hysteresis that keeps the device from responding to power-on glitches during start up. If desired the turn-on point of the supply can be changed by using the precision enable pin and a resistor divider network connected to VIN as shown in *Figure 6* in the design guide.

### THERMAL PROTECTION

Internal thermal shutdown circuitry is provided to protect the integrated circuit in the event that the maximum junction tem-

perature is exceeded. When activated, typically at 160°C, the LM20145 tri-states the power FETs and resets soft start. After the junction cools to approximately 150°C, the part starts up using the normal start up routine. This feature is provided to prevent catastrophic failures from accidental device overheating.

### LIGHT LOAD OPERATION

The LM20145 offers increased efficiency when operating at light loads. Whenever the load current is reduced to a point where the peak to peak inductor ripple current is greater than two times the load current, the part will enter the diode emulation mode preventing significant negative inductor current. The point at which this occurs is the critical conduction boundary and can be calculated by the following equation:

$$I_{\text{BOUNDARY}} = \frac{(V_{\text{IN}} - V_{\text{OUT}}) \times D}{2 \times L \times f_{\text{SW}}}$$

Several diagrams are shown in *Figure 1* illustrating continuous conduction mode (CCM), discontinuous conduction mode, and the boundary condition.

It can be seen that in diode emulation mode, whenever the inductor current reaches zero the SW node will become high impedance. Ringing will occur on this pin as a result of the LC tank circuit formed by the inductor and the parasitic capacitance at the node. If this ringing is of concern an additional RC snubber circuit can be added from the switch node to ground.

At very light loads, usually below 100 mA, several pulses may be skipped in between switching cycles, effectively reducing the switching frequency and further improving light-load efficiency.

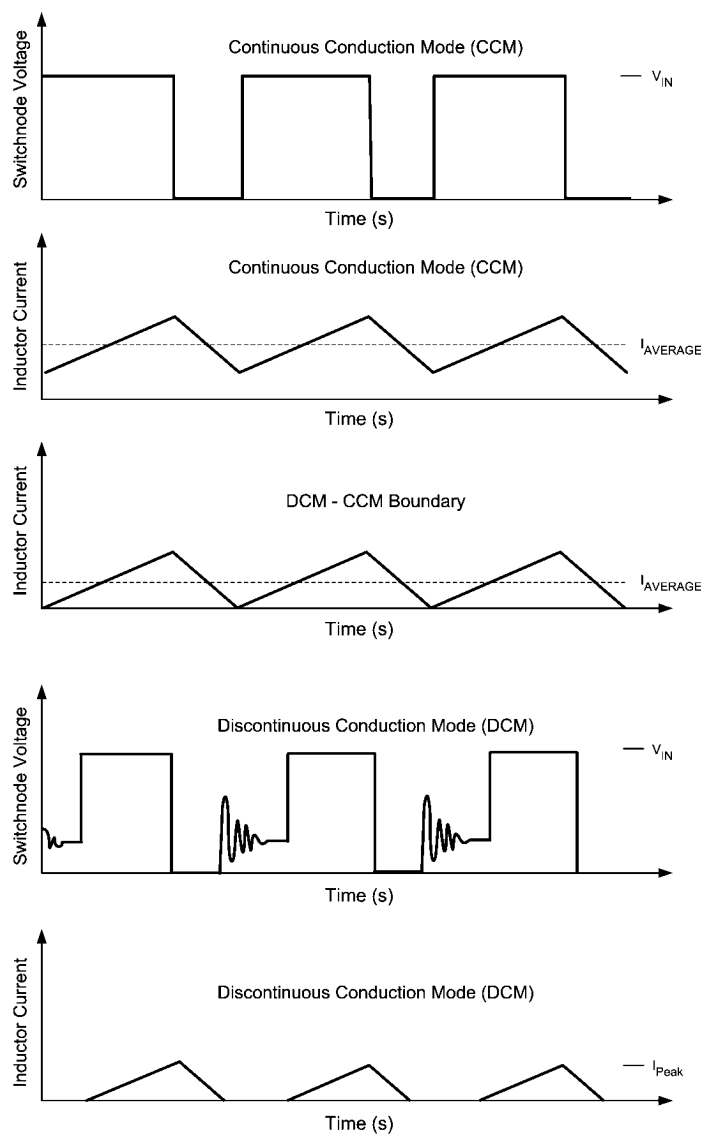

30030705

**FIGURE 1. Modes of Operation for LM20145**

## Design Guide

This section walks the designer through the steps necessary to select the external components to build a fully functional power supply. As with any DC-DC converter numerous trade-offs are possible to optimize the design for efficiency, size, or performance. These will be taken into account and highlighted throughout this discussion. To facilitate component selection discussions the circuit shown in *Figure 2* below may be used as a reference. Unless otherwise indicated all formulas assume units of amps (A) for current, farads (F) for capacitance, henries (H) for inductance and volts (V) for voltages.

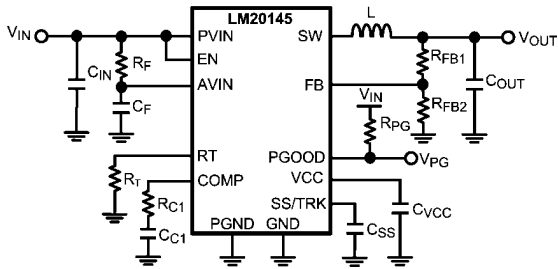

30030723

FIGURE 2. Typical Application Circuit

The first equation to calculate for any buck converter is duty cycle. Ignoring conduction losses associated with the FETs and parasitic resistances it can be approximated by:

$$D = \frac{V_{OUT}}{V_{IN}}$$

### INDUCTOR SELECTION (L)

The inductor value is determined based on the operating frequency, load current, ripple current, and duty cycle.

The inductor selected should have a saturation current rating greater than the peak current limit of the device. Keep in mind the specified current limit does not account for delay of the current limit comparator, therefore the current limit in the application may be higher than the specified value. To optimize the performance and prevent the device from entering current limit at maximum load, the inductance is typically selected such that the ripple current,  $\Delta i_L$ , is less than 30% of the rated output current. *Figure 3*, shown below illustrates the switch and inductor ripple current waveforms. Once the input voltage, output voltage, operating frequency, and desired ripple current are known, the minimum value for the inductor can be calculated by the formula shown below:

$$L_{MIN} = \frac{(V_{IN} - V_{OUT}) \times D}{\Delta i_L \times f_{SW}}$$

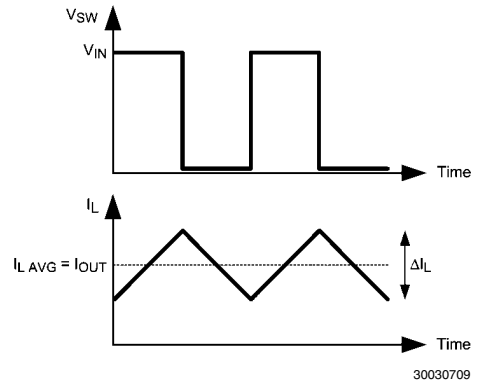

30030709

FIGURE 3. Switch and Inductor Current Waveforms

If needed, slightly smaller value inductors can be used, however, the peak inductor current,  $I_{OUT} + \Delta i_L/2$ , should be kept below the peak current limit of the device. In general, the inductor ripple current,  $\Delta i_L$ , should be greater than 10% of the rated output current to provide adequate current sense information for the current mode control loop. If the ripple current in the inductor is too low, the control loop will not have sufficient current sense information and can be prone to instability.

### OUTPUT CAPACITOR SELECTION ( $C_{OUT}$ )

The output capacitor,  $C_{OUT}$ , filters the inductor ripple current and provides a source of charge for transient load conditions. A wide range of output capacitors may be used with the LM20145 that provide excellent performance. The best performance is typically obtained using ceramic, SP, or OSCON type chemistries. Typical trade-offs are that the ceramic capacitor provides extremely low ESR to reduce the output ripple voltage and noise spikes, while the SP and OSCON capacitors provide a large bulk capacitance in a small volume for transient loading conditions.

When selecting the value for the output capacitor the two performance characteristics to consider are the output voltage ripple and transient response. The output voltage ripple can be approximated by using the formula shown below.

$$\Delta V_{OUT} = \Delta i_L \times \left[ R_{ESR} + \frac{1}{8 \times f_{SW} \times C_{OUT}} \right]$$

Where,  $\Delta V_{OUT}$  (V) is the amount of peak to peak voltage ripple at the power supply output,  $R_{ESR}$  ( $\Omega$ ) is the series resistance of the output capacitor,  $f_{SW}$  (Hz) is the switching frequency, and  $C_{OUT}$  (F) is the output capacitance used in the design. The amount of output ripple that can be tolerated is application specific; however a general recommendation is to keep the output ripple less than 1% of the rated output voltage. Keep in mind ceramic capacitors are sometimes preferred because they have very low ESR; however, depending on package and voltage rating of the capacitor the value of the capacitance can drop significantly with applied voltage. The output capacitor selection will also affect the output voltage droop during a load transient. The peak droop on the output voltage during a load transient is dependent on many factors; however, an approximation of the transient droop ignoring loop bandwidth can be obtained using the following equation.

$$V_{DROOP} = \Delta I_{OUTSTEP} \times R_{ESR} + \frac{L \times \Delta I_{OUTSTEP}^2}{C_{OUT} \times (V_{IN} - V_{OUT})}$$

Where,  $C_{OUT}$  (F) is the minimum required output capacitance,  $L$  (H) is the value of the inductor,  $V_{DROOP}$  (V) is the output voltage drop ignoring loop bandwidth considerations,  $\Delta I_{OUT-STEP}$  (A) is the load step change,  $R_{ESR}$  ( $\Omega$ ) is the output capacitor ESR,  $V_{IN}$  (V) is the input voltage, and  $V_{OUT}$  (V) is the set regulator output voltage. Both the tolerance and voltage coefficient of the capacitor needs to be examined when designing for a specific output ripple or transient drop target.

### INPUT CAPACITOR SELECTION ( $C_{IN}$ )

Good quality input capacitors are necessary to limit the ripple voltage at the VIN pin while supplying most of the switch current during the on-time. In general it is recommended to use a ceramic capacitor for the input as they provide both a low impedance and small footprint. One important note is to use a good dielectric for the ceramic capacitor such as X5R or X7R. These provide better over temperature performance and also minimize the DC voltage derating that occurs on Y5V capacitors. For most applications, a 22  $\mu$ F, X5R, 6.3V input capacitor is sufficient; however, additional capacitance may be required if the connection to the input supply is far from the PVIN pins. The input capacitor should be placed as close as possible to PVIN and PGND pins of the device.

Non-ceramic input capacitors should be selected for RMS current rating and minimum ripple voltage. A good approximation for the required ripple current rating is given by the relationship:

$$I_{IN-RMS} = I_{OUT} \sqrt{D(1-D)}$$

As indicated by the RMS ripple current equation, highest requirement for RMS current rating occurs at 50% duty cycle. For this case, the RMS ripple current rating of the input capacitor should be greater than half the output current. For best performance, low ESR ceramic capacitors should be placed in parallel with higher capacitance capacitors to provide the best input filtering for the device.

### SETTING THE OUTPUT VOLTAGE ( $R_{FB1}$ , $R_{FB2}$ )

The resistors  $R_{FB1}$  and  $R_{FB2}$  are selected to set the output voltage for the device. Table 1, shown below, provides suggestions for  $R_{FB1}$  and  $R_{FB2}$  for common output voltages.

**TABLE 1. Suggested Values for  $R_{FB1}$  and  $R_{FB2}$**

$R_{FB1}$ (k $\Omega$ )	$R_{FB2}$ (k $\Omega$ )	$V_{OUT}$
short	open	0.8
4.99	10	1.2
8.87	10.2	1.5
12.7	10.2	1.8
21.5	10.2	2.5
31.6	10.2	3.3

If different output voltages are required,  $R_{FB2}$  should be selected to be between 4.99 k $\Omega$  to 49.9 k $\Omega$  and  $R_{FB1}$  can be calculated using the equation below.

$$R_{FB1} = \left( \frac{V_{OUT}}{0.8} - 1 \right) \times R_{FB2}$$

### ADJUSTING THE OPERATING FREQUENCY ( $R_T$ )

The operating frequency of the LM20145 can be adjusted by connecting a resistor from the RT pin to ground. The equation

shown below can be used to calculate the value of  $R_T$  for a given operating frequency.

$$R_T = \left( \frac{78000}{f_{SW}} \right) - 55$$

Where,  $f_{SW}$  is the switching frequency in kHz, and  $R_T$  is the frequency adjust resistor in k $\Omega$ . Please refer to the curve Oscillator Frequency versus  $R_T$  in the typical performance characteristics section. If the  $R_T$  resistor is omitted the device will not operate.

### LOOP COMPENSATION ( $R_{C1}$ , $C_{C1}$ )

The purpose of loop compensation is to meet static and dynamic performance requirements while maintaining adequate stability. Optimal loop compensation depends on the output capacitor, inductor, load, and the device itself. Table 2 below gives values for the compensation network that will result in a stable system when using a 100  $\mu$ F, 6.3V ceramic X5R output capacitor and 1  $\mu$ H inductor.

**TABLE 2. Recommended Compensation for  $C_{OUT} = 100 \mu$ F,  $L = 2.5 \mu$ H &  $f_{SW} = 250$  kHz**

$V_{IN}$	$V_{OUT}$	$C_{C1}$ (nF)	$R_{C1}$ (k $\Omega$ )
5.00	3.30	4.7	11
5.00	2.50	4.7	9.53
5.00	1.80	4.7	6.98
5.00	1.50	4.7	5.36
5.00	1.20	4.7	4.87
5.00	0.80	4.7	1.91
3.30	2.50	4.7	10.5
3.30	1.80	4.7	7.87
3.30	1.50	4.7	5.62
3.30	1.20	4.7	4.42
3.30	0.80	4.7	2.26

If the desired solution differs from the table above the loop transfer function should be analyzed to optimize the loop compensation. The overall loop transfer function is the product of the power stage and the feedback network transfer functions. For stability purposes, the objective is to have a loop gain slope that is -20db/decade from a very low frequency to beyond the crossover frequency. Figure 4, shown below, shows the transfer functions for power stage, feedback/compensation network, and the resulting closed loop system for the LM20145.

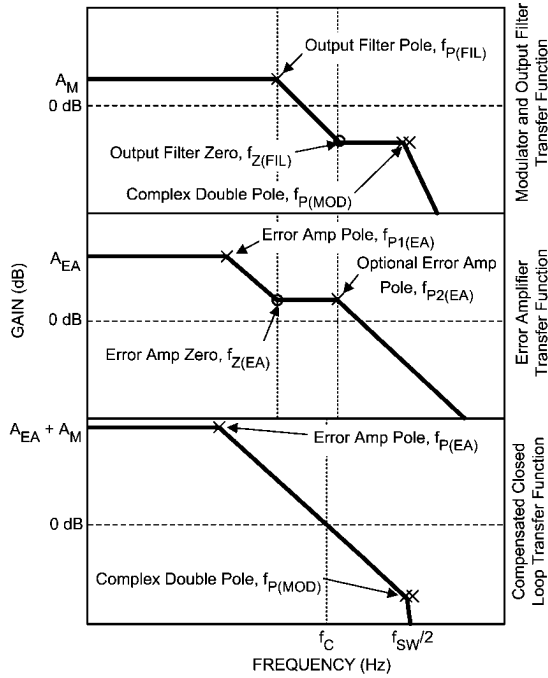

30030713

**FIGURE 4. LM20145 Loop Compensation**

The power stage transfer function is dictated by the modulator, output LC filter, and load; while the feedback transfer function is set by the feedback resistor ratio, error amp gain, and external compensation network.

To achieve a -20dB/decade slope, the error amplifier zero, located at  $f_{Z(EA)}$ , should be positioned to cancel the output filter pole ( $f_{P(FIL)}$ ). An additional error amp pole, located at  $f_{P2(EA)}$ , can be added to cancel the output filter zero at  $f_{Z(FIL)}$ . Cancellation of the output filter zero is recommended if larger value, non-ceramic output capacitors are used.

Compensation of the LM20144 is achieved by adding an RC network as shown in *Figure 5* below.

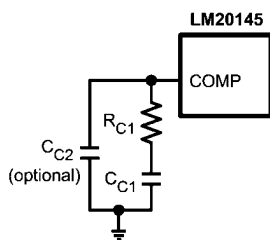

30030714

**FIGURE 5. Compensation Network for LM20145**

A good starting value for  $C_{C1}$  for most applications is 4.7 nF. Once the value of  $C_{C1}$  is chosen the value of RC should be calculated using the equation below to cancel the output filter pole ( $F_{P(FIL)}$ ) as shown in *Figure 4*.

$$R_{C1} = \left[ \frac{C_{C1}}{C_{OUT}} \times \left[ \frac{I_{OUT}}{V_{OUT}} + \frac{1-D}{f_{SW} \times L} + \frac{10 \times D}{V_{IN}} \right] \right]^{-1}$$

A higher crossover frequency can be obtained, usually at the expense of phase margin, by lowering the value of  $C_{C1}$  and recalculating the value of  $R_{C1}$ . Likewise, increasing  $C_{C1}$  and recalculating  $R_{C1}$  will provide additional phase margin at a lower crossover frequency. As with any attempt to compensate the LM20145 the stability of the system should be verified for desired transient droop and settling time.

If the output filter zero,  $F_{Z(FIL)}$  approaches the crossover frequency ( $F_C$ ), an additional capacitor ( $C_{C2}$ ) should be placed at the COMP pin to ground. This capacitor adds a pole to cancel the output filter zero assuring the crossover frequency will occur before the double pole at  $f_{SW}/2$  degrades the phase margin. The output filter zero is set by the output capacitor value and ESR as shown in the equation below.

$$f_{Z(FIL)} = \frac{1}{2 \times \pi \times C_{OUT} \times R_{ESR}}$$

If needed, the value for  $C_{C2}$  should be calculated using the equation shown below.

$$C_{C2} = \frac{C_{OUT} \times R_{ESR}}{R_{C1}}$$

Where  $R_{ESR}$  is the output capacitor series resistance and  $R_{C1}$  is the calculated compensation resistance.

**AVIN FILTERING COMPONENTS ( $C_F$  and  $R_F$ )**

To prevent high frequency noise spikes from disturbing the sensitive analog circuitry connected to the AVIN and AGND pins, a high frequency RC filter is required between PVIN and AVIN. These components are shown in *Figure 2*. as  $C_F$  and  $R_F$ . The required value for  $R_F$  is 1Ω.  $C_F$  must be used. Recommended value of  $C_F$  is 1.0 μF. The filter capacitor,  $C_F$  should be placed as close to the IC as possible with a direct connection from AVIN to AGND. A good quality X5R or X7R ceramic capacitor should be used for  $C_F$ .

**SUB-REGULATOR BYPASS CAPACITOR ( $C_{VCC}$ )**

The capacitor at the VCC pin provides noise filtering and stability for the internal sub-regulator. The recommended value of  $C_{VCC}$  should be no smaller than 1 μF and no greater than 10 μF. The capacitor should be a good quality ceramic X5R or X7R capacitor. In general, a 1 μF ceramic capacitor is recommended for most applications.

**SETTING THE START UP TIME ( $C_{SS}$ )**

The addition of a capacitor connected from the SS pin to ground sets the time at which the output voltage will reach the final regulated value. Larger values for  $C_{SS}$  will result in longer start up times. Table 3, shown below provides a list of soft start capacitors and the corresponding typical start up times.

**TABLE 3. Start Up Times for Different Soft-Start Capacitors**

Start Up Time (ms)	$C_{SS}$ (nF)
1	none
5	33
10	68
15	100
20	120

If different start up times are needed the equation shown below can be used to calculate the start up time.

$$t_{SS} = \frac{0.8V \times C_{SS}}{I_{SS}}$$

As shown above, the start up time is influenced by the value of the Soft-Start capacitor  $C_{SS}$ (F) and the 5  $\mu$ A Soft-Start pin current  $I_{SS}$ (A). that may be found in the electrical characteristics table.

While the Soft-Start capacitor can be sized to meet many start up requirements, there are limitations to its size. The Soft-Start time can never be faster than 1ms due to the internal default 1 ms start up time. When the device is enabled there is an approximate time interval of 50  $\mu$ s when the Soft-Start capacitor will be discharged just prior to the Soft-Start ramp. If the enable pin is rapidly pulsed or the Soft-Start capacitor is large there may not be enough time for  $C_{SS}$  to completely discharge resulting in start up times less than predicted. To aid in discharging of Soft-Start capacitor during long disable periods an external 1 M $\Omega$  resistor from SS/TRK to ground can be used without greatly affecting the start-up time.

**USING PRECISION ENABLE AND POWER GOOD**

The precision enable (EN) and power good (PGOOD) pins of the LM20145 can be used to address many sequencing requirements. The turn-on of the LM20145 can be controlled with the precision enable pin by using two external resistors as shown in Figure 6.

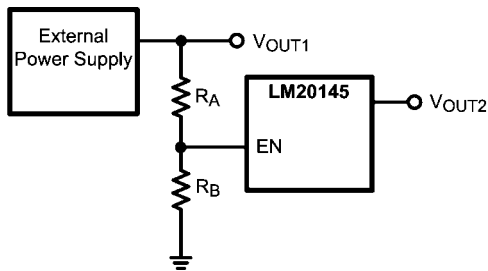

30030726

**FIGURE 6. Sequencing LM20145 with Precision Enable**

The value for resistor  $R_B$  can be selected by the user to control the current through the divider. Typically this resistor will be selected to be between 10 k $\Omega$  and 1 M $\Omega$ . Once the value for  $R_B$  is chosen the resistor  $R_A$  can be solved using the equation below to set the desired turn-on voltage.

$$R_A = \left( \frac{V_{TO}}{V_{IH\_EN}} - 1 \right) \times R_B$$

When designing for a specific turn-on threshold ( $V_{TO}$ ) the tolerance on the input supply, enable threshold ( $V_{IH\_EN}$ ), and external resistors needs to be considered to insure proper turn-on of the device.

The LM20145 features an open drain power good (PGOOD) pin to sequence external supplies or loads and to provide fault detection. This pin requires an external resistor ( $R_{PG}$ ) to pull PGOOD high while when the output is within the PGOOD tolerance window. Typical values for this resistor range from 10 k $\Omega$  to 100 k $\Omega$ .

**TRACKING AN EXTERNAL SUPPLY**

By using a properly chosen resistor divider network connected to the SS/TRK pin, as shown in Figure 7, the output of the LM20145 can be configured to track an external voltage source to obtain a simultaneous or ratiometric start up.

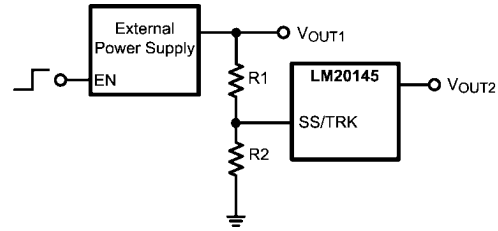

30030720

**FIGURE 7. Tracking an External Supply**

Since the Soft-Start charging current  $I_{SS}$  is always present on the SS/TRK pin, the size of  $R_2$  should be less than 10 k $\Omega$  to minimize the errors in the tracking output. Once a value for  $R_2$  is selected the value for  $R_1$  can be calculated using appropriate equation in Figure 8, to give the desired start up. Figure 8 shows two common start up sequences; the top waveform shows a simultaneous start up while the waveform at the bottom illustrates a ratiometric start up.

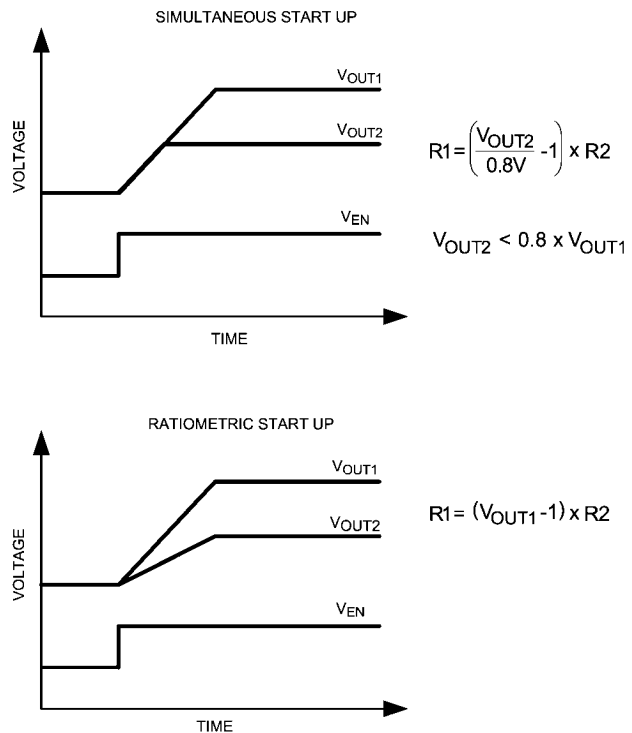

30030721

**FIGURE 8. Common Start Up Sequences**

A simultaneous start up is preferred when powering most FPGAs, DSPs, or other microprocessors. In these systems the higher voltage,  $V_{OUT1}$ , usually powers the I/O, and the lower voltage,  $V_{OUT2}$ , powers the core. A simultaneous start up provides a more robust power up for these applications since it avoids turning on any parasitic conduction paths that may exist between the core and the I/O pins of the processor..

The second most common power on behavior is known as a ratiometric start up. This start up is preferred in applications where both supplies need to be at the final value at the same time.

Similar to the Soft-Start function, the fastest start up possible is 1ms regardless of the rise time of the tracking voltage. When using the track feature the final voltage seen by the SS/TRACK pin should exceed 1V to provide sufficient overdrive and transient immunity.

### THERMAL CONSIDERATIONS

The thermal characteristics of the LM20145 are specified using the parameter  $\theta_{JA}$ , which relates the junction temperature to the ambient temperature. Although the value of  $\theta_{JA}$  is dependant on many variables, it still can be used to approximate the operating junction temperature of the device.

To obtain an estimate of the device junction temperature, one may use the following relationship:

$$T_J = P_D \theta_{JA} + T_A$$

and

$$P_D = P_{IN} \times (1 - \text{Efficiency}) - 1.1 \times I_{OUT} \times \text{DCR}$$

Where:

$T_J$  is the junction temperature in °C.

$P_{IN}$  is the input power in Watts ( $P_{IN} = V_{IN} \times I_{IN}$ ).

$\theta_{JA}$  is the junction to ambient thermal resistance for the LM20145.

$T_A$  is the ambient temperature in °C.

$I_{OUT}$  is the output load current.

DCR is the inductor series resistance.

It is important to always keep the operating junction temperature ( $T_J$ ) below 125°C for reliable operation. If the junction temperature exceeds 160°C the device will cycle in and out of thermal shutdown. If thermal shutdown occurs it is a sign of inadequate heatsinking or excessive power dissipation in the device.

Figure 9, shown below, provides a better approximation of the  $\theta_{JA}$  for a given PCB copper area. The PCB heatsink area consists of 2oz. copper located on the bottom layer of the PCB directly under the eTSSOP exposed pad. The bottom copper area is connected to the eTSSOP exposed pad by means of a 4 x 4 array of 12 mil thermal vias.

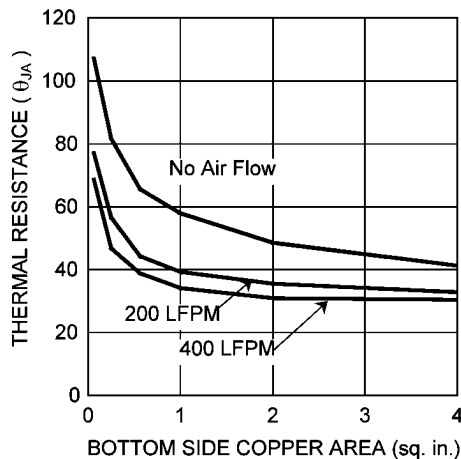

30030735

FIGURE 9. Thermal Resistance vs PCB Area

### PCB LAYOUT CONSIDERATIONS

PC board layout is an important part of DC-DC converter design. Poor board layout can disrupt the performance of a DC-DC converter and surrounding circuitry by contributing to EMI, ground bounce, and resistive voltage loss in the traces. These can send erroneous signals to the DC-DC converter resulting in poor regulation or instability.

Good layout can be implemented by following a few simple design rules.

1. Minimize area of switched current loops. In a buck regulator there are two loops where currents are switched very fast. The first loop starts from the input capacitor, to the regulator VIN pin, to the regulator SW pin, to the inductor then out to the output capacitor and load. The second loop starts from the output capacitor ground, to the regulator PGND pins, to the inductor and then out to the load (see Figure 10). To minimize both loop areas the input capacitor should be placed as close as possible to the PVIN pin. Grounding for both the input and output capacitor should consist of a small localized top side plane that connects to PGND and the die attach pad (DAP). The inductor should be placed as close as possible to the SW pin and output capacitor.

2. Minimize the copper area of the switch node. Since the LM20145 has the SW pins on opposite sides of the package it is recommended to via these pins down to the bottom or internal layer with 2 to 4 vias on each SW pin. The SW pins should be directly connected with a trace that runs across the bottom of the package. To minimize IR losses this trace should be no smaller than 50 mils wide, but no larger than 100 mils wide to keep the copper area to a minimum. In general the SW pins should not be connected on the top layer since it could block the ground return path for the power ground. The inductor should be placed as close as possible to one of the SW pins to further minimize the copper area of the switch node.

3. Have a single point ground for all device analog grounds located under the DAP. The ground connections for the compensation, feedback, and Soft-Start components should be connected together then routed to the AGND pin of the device. The AGND pin should connect to PGND under the DAP. This prevents any switched or load currents from flowing in the analog ground plane. If not properly handled poor grounding can result in degraded load regulation or erratic switching behavior.

4. Minimize trace length to the FB pin. Since the feedback node can be high impedance the trace from the output resistor divider to FB pin should be as short as possible. This is most important when high value resistors are used to set the output voltage. The feedback trace should be routed away from the SW pin and inductor to avoid contaminating the feedback signal with switch noise.

5. Make input and output bus connections as wide as possible. This reduces any voltage drops on the input or output of the converter and can improve efficiency. If voltage accuracy at the load is important make sure feedback voltage sense is made at the load. Doing so will correct for voltage drops at the load and provide the best output accuracy.

6. Provide adequate device heatsinking. Use as many vias as is possible to connect the DAP to the power plane heatsink. For best results use a 4x4 via array with a minimum via diameter of 12 mils. See the Thermal Considerations section to insure enough copper heatsinking area is used to keep the junction temperature below 125°C.



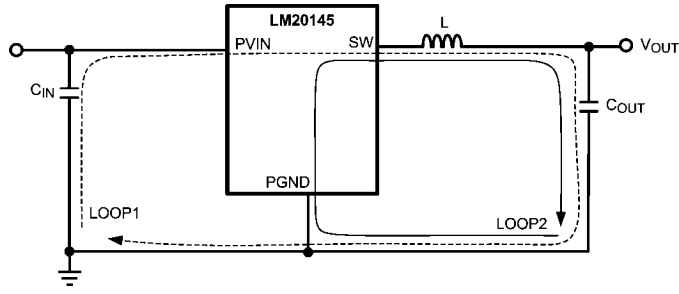

30030722

**FIGURE 10. Schematic of LM20145 Highlighting Layout Sensitive Nodes**

## Typical Application Circuits

This section provides several application solutions with a bill of materials. All bill of materials reference the below figure.

The compensation for these solutions were optimized to work over a wide range of input and output voltages; if a faster transient response is needed reduce the value of  $C_{C1}$  and calculate the new value for  $R_{C1}$  as outline in the design guide.

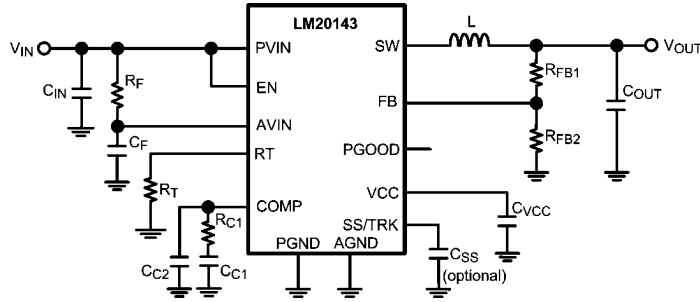

30030760

FIGURE 11.

### Bill of Materials ( $V_{IN} = 5V$ , $V_{OUT} = 3.3V$ , $F_{SW} = 300kHz$ , $I_{OUTMAX} = 5A$ )

Designator	Description	Part Number	Manufacturer	Qty
U1	Synchronous Buck Regulator	LM20145	National Semiconductor	1
$C_{IN}$	100 $\mu F$ , 1210, X5R, 6.3V	GRM32ER60J107ME20	Murata	1
$C_{OUT}$	330 $\mu F$ , 6.3V	6TPE330ML	Sanyo	1
L	2.2 $\mu H$ , 8.2 m $\Omega$	IHLP4040DZER2R2M01	Vishay	1
$R_F$	1 $\Omega$ , 0603	CRCW06031R0J-e3	Vishay-Dale	1
$C_F$	100 nF, 0603, X7R, 16V	GRM188R71C104KA01	Murata	1
$C_{VCC}$	1 $\mu F$ , 0603, X5R, 6.3V	GRM188R60J105KA01	Murata	1
$R_{C1}$	49.9 k $\Omega$ , 0603	CRCW06034992F-e3	Vishay-Dale	1
$C_{C1}$	2.2 nF, 0603, X7R, 25V	VJ0603Y222KXXA	Vishay-Vitramon	1
$C_{C2}$	100 pF, 0603, COG, 50V	VJ0603A101KXAA	Vishay-Dale	1
$C_{SS}$	33 nF, 0603, X7R, 25V	VJ0603Y333KXXA	Vishay-Vitramon	1
$R_T$	205 k $\Omega$ , 0603	CRCW06032053F-e3	Vishay-Dale	1
$R_{FB1}$	31.6 k $\Omega$ , 0603	CRCW06033162F-e3	Vishay-Dale	1
$R_{FB2}$	10.2 k $\Omega$ , 0603	CRCW06031022F-e3	Vishay-Dale	1

### Bill of Materials ( $V_{IN} = 3.3V$ to $5V$ , $V_{OUT} = 1.2V$ , $F_{SW} = 300kHz$ , $I_{OUTMAX} = 5A$ )

Designator	Description	Part Number	Manufacturer	Qty
U1	Synchronous Buck Regulator	LM20145	National Semiconductor	1
$C_{IN}$	100 $\mu F$ , 1210, X5R, 6.3V	GRM32ER60J107ME20	Murata	1
$C_{OUT}$	330 $\mu F$ , 6.3V	6TPE330ML	Sanyo	1
L	2.2 $\mu H$ , 8.2 m $\Omega$	IHLP4040DZER2R2M01	Vishay	1
$R_F$	1 $\Omega$ , 0603	CRCW06031R0J-e3	Vishay-Dale	1
$C_F$	100 nF, 0603, X7R, 16V	GRM188R71C104KA01	Murata	1
$C_{VCC}$	1 $\mu F$ , 0603, X5R, 6.3V	GRM188R60J105KA01	Murata	1
$R_{C1}$	20 k $\Omega$ , 0603	CRCW06032002F-e3	Vishay-Dale	1
$C_{C1}$	3.3 nF, 0603, X7R, 25V	VJ0603Y332KXXA	Vishay-Vitramon	1
$C_{C2}$	330 pF, 0603, COG, 50V	VJ0603A331AKXAA	Vishay-Dale	1
$C_{SS}$	33 nF, 0603, X7R, 25V	VJ0603Y333KXXA	Vishay-Vitramon	1
$R_T$	205 k $\Omega$ , 0603	CRCW06032053F-e3	Vishay-Dale	1

Designator	Description	Part Number	Manufacturer	Qty
R <sub>FB1</sub>	4.99 k $\Omega$ , 0603	CRCW06034991F-e3	Vishay-Dale	1
R <sub>FB2</sub>	10 k $\Omega$ , 0603	CRCW06031002F-e3	Vishay-Dale	1

**Physical Dimensions** inches (millimeters) unless otherwise noted

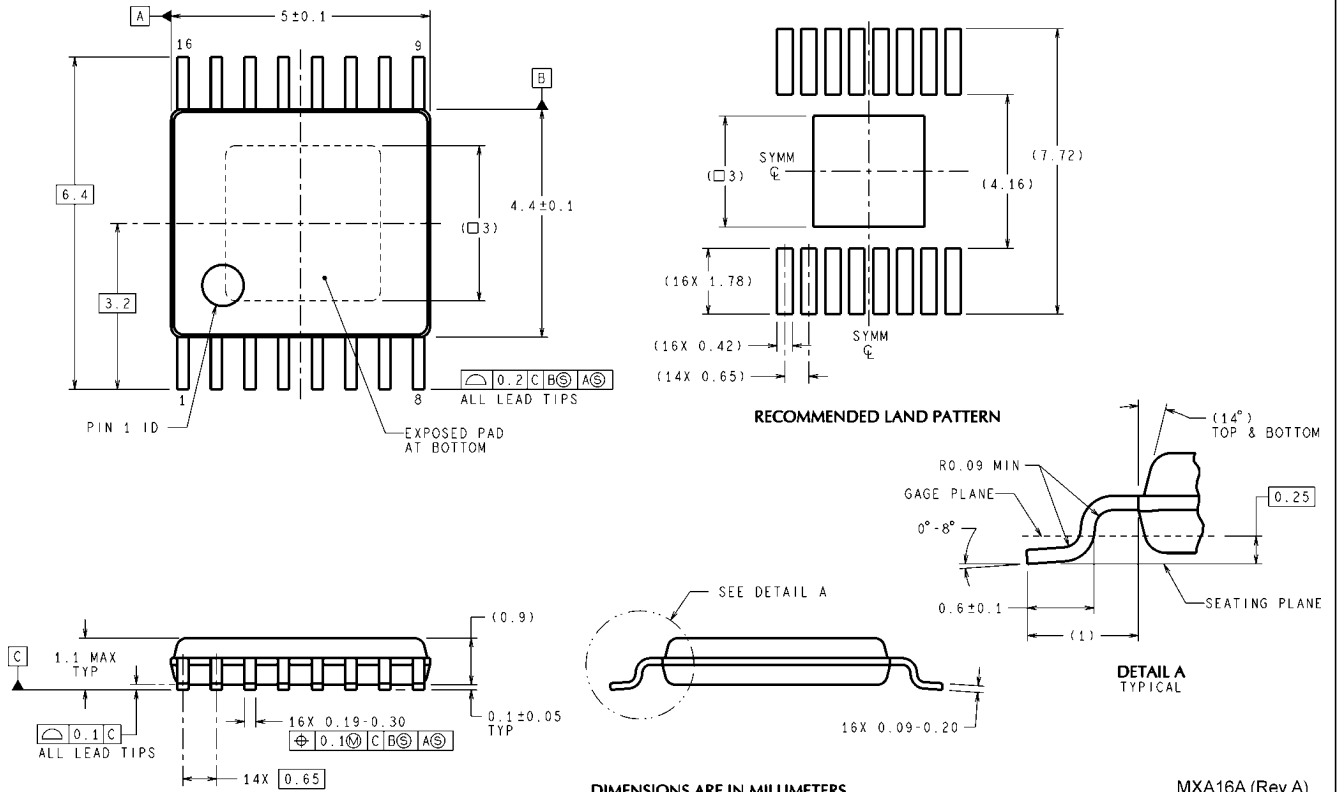

MXA16A (Rev A)

# Notes

LM20145

## Notes

For more National Semiconductor product information and proven design tools, visit the following Web sites at:

Products		Design Support	
Amplifiers	<a href="http://www.national.com/amplifiers">www.national.com/amplifiers</a>	WEBENCH	<a href="http://www.national.com/webench">www.national.com/webench</a>
Audio	<a href="http://www.national.com/audio">www.national.com/audio</a>	Analog University	<a href="http://www.national.com/AU">www.national.com/AU</a>
Clock Conditioners	<a href="http://www.national.com/timing">www.national.com/timing</a>	App Notes	<a href="http://www.national.com/appnotes">www.national.com/appnotes</a>
Data Converters	<a href="http://www.national.com/adc">www.national.com/adc</a>	Distributors	<a href="http://www.national.com/contacts">www.national.com/contacts</a>
Displays	<a href="http://www.national.com/displays">www.national.com/displays</a>	Green Compliance	<a href="http://www.national.com/quality/green">www.national.com/quality/green</a>
Ethernet	<a href="http://www.national.com/ethernet">www.national.com/ethernet</a>	Packaging	<a href="http://www.national.com/packaging">www.national.com/packaging</a>
Interface	<a href="http://www.national.com/interface">www.national.com/interface</a>	Quality and Reliability	<a href="http://www.national.com/quality">www.national.com/quality</a>
LVDS	<a href="http://www.national.com/lvds">www.national.com/lvds</a>	Reference Designs	<a href="http://www.national.com/refdesigns">www.national.com/refdesigns</a>
Power Management	<a href="http://www.national.com/power">www.national.com/power</a>	Feedback	<a href="http://www.national.com/feedback">www.national.com/feedback</a>
Switching Regulators	<a href="http://www.national.com/switchers">www.national.com/switchers</a>		
LDOs	<a href="http://www.national.com/lido">www.national.com/lido</a>		
LED Lighting	<a href="http://www.national.com/led">www.national.com/led</a>		
PowerWise	<a href="http://www.national.com/powerwise">www.national.com/powerwise</a>		
Serial Digital Interface (SDI)	<a href="http://www.national.com/sdi">www.national.com/sdi</a>		
Temperature Sensors	<a href="http://www.national.com/tempsensors">www.national.com/tempsensors</a>		
Wireless (PLL/VCO)	<a href="http://www.national.com/wireless">www.national.com/wireless</a>		

THE CONTENTS OF THIS DOCUMENT ARE PROVIDED IN CONNECTION WITH NATIONAL SEMICONDUCTOR CORPORATION ("NATIONAL") PRODUCTS. NATIONAL MAKES NO REPRESENTATIONS OR WARRANTIES WITH RESPECT TO THE ACCURACY OR COMPLETENESS OF THE CONTENTS OF THIS PUBLICATION AND RESERVES THE RIGHT TO MAKE CHANGES TO SPECIFICATIONS AND PRODUCT DESCRIPTIONS AT ANY TIME WITHOUT NOTICE. NO LICENSE, WHETHER EXPRESS, IMPLIED, ARISING BY ESTOPPEL OR OTHERWISE, TO ANY INTELLECTUAL PROPERTY RIGHTS IS GRANTED BY THIS DOCUMENT.

TESTING AND OTHER QUALITY CONTROLS ARE USED TO THE EXTENT NATIONAL DEEMS NECESSARY TO SUPPORT NATIONAL'S PRODUCT WARRANTY. EXCEPT WHERE MANDATED BY GOVERNMENT REQUIREMENTS, TESTING OF ALL PARAMETERS OF EACH PRODUCT IS NOT NECESSARILY PERFORMED. NATIONAL ASSUMES NO LIABILITY FOR APPLICATIONS ASSISTANCE OR BUYER PRODUCT DESIGN. BUYERS ARE RESPONSIBLE FOR THEIR PRODUCTS AND APPLICATIONS USING NATIONAL COMPONENTS. PRIOR TO USING OR DISTRIBUTING ANY PRODUCTS THAT INCLUDE NATIONAL COMPONENTS, BUYERS SHOULD PROVIDE ADEQUATE DESIGN, TESTING AND OPERATING SAFEGUARDS.

EXCEPT AS PROVIDED IN NATIONAL'S TERMS AND CONDITIONS OF SALE FOR SUCH PRODUCTS, NATIONAL ASSUMES NO LIABILITY WHATSOEVER, AND NATIONAL DISCLAIMS ANY EXPRESS OR IMPLIED WARRANTY RELATING TO THE SALE AND/OR USE OF NATIONAL PRODUCTS INCLUDING LIABILITY OR WARRANTIES RELATING TO FITNESS FOR A PARTICULAR PURPOSE, MERCHANTABILITY, OR INFRINGEMENT OF ANY PATENT, COPYRIGHT OR OTHER INTELLECTUAL PROPERTY RIGHT.

### LIFE SUPPORT POLICY

**NATIONAL'S PRODUCTS ARE NOT AUTHORIZED FOR USE AS CRITICAL COMPONENTS IN LIFE SUPPORT DEVICES OR SYSTEMS WITHOUT THE EXPRESS PRIOR WRITTEN APPROVAL OF THE CHIEF EXECUTIVE OFFICER AND GENERAL COUNSEL OF NATIONAL SEMICONDUCTOR CORPORATION.** As used herein:

Life support devices or systems are devices which (a) are intended for surgical implant into the body, or (b) support or sustain life and whose failure to perform when properly used in accordance with instructions for use provided in the labeling can be reasonably expected to result in a significant injury to the user. A critical component is any component in a life support device or system whose failure to perform can be reasonably expected to cause the failure of the life support device or system or to affect its safety or effectiveness.

National Semiconductor and the National Semiconductor logo are registered trademarks of National Semiconductor Corporation. All other brand or product names may be trademarks or registered trademarks of their respective holders.

Copyright© 2008 National Semiconductor Corporation

For the most current product information visit us at [www.national.com](http://www.national.com)



**National Semiconductor  
Americas Technical  
Support Center**  
Email:  
[new.feedback@nsc.com](mailto:new.feedback@nsc.com)  
Tel: 1-800-272-9959

**National Semiconductor Europe  
Technical Support Center**  
Email: [europe.support@nsc.com](mailto:europe.support@nsc.com)  
German Tel: +49 (0) 180 5010 771  
English Tel: +44 (0) 870 850 4288

**National Semiconductor Asia  
Pacific Technical Support Center**  
Email: [ap.support@nsc.com](mailto:ap.support@nsc.com)

**National Semiconductor Japan  
Technical Support Center**  
Email: [jpn.feedback@nsc.com](mailto:jpn.feedback@nsc.com)