

Force Guided Relay SR2M

- 2 pole relay with force guided contacts according to EN 50205
- Reinforced insulation between poles

Typical applications
Emergency shut-off, press control, machine control, elevator and escalator control, safety relays



F0188-D



Approvals
VDE 116064, UL E214025, TUV 968/EZ 111, CQC0617015579
Technical data of approved types on request

Contact Data

Contact arrangement	1 form A + 1 form B contacts (1 NO + 1 NC) or 2 form C contacts (2 CO)
According to EN50205 only 1NO / 1NC (11-14 and 22-21 or 12-11 and 21-24) shall be used as force guided contacts.	
Rated voltage	250VAC
Max. switching voltage	400VAC
Rated current	6A
Contact material	AgNi
Contact style	single contact, force guided
1 form A + B, 1 NO + 1NC	type A according to EN 50205
2 form C, 2CO	type B according to EN 50205
Min. recommended contact load	5V/10mA
Initial contact resistance	≤100mΩ at 1A, 24VDC ≤20Ω at 10mA, 5VDC
Frequency of operation, with/without load	6/300min ⁻¹
Contact ratings, IEC60947-5-1, on 1 form A (NO) contact	AC15-3A DC13-6A
Mechanical endurance	10x10 ⁶ operations

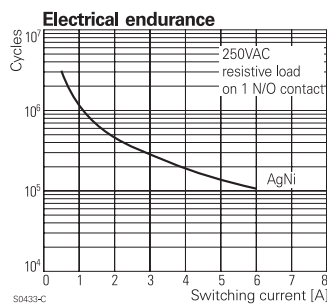
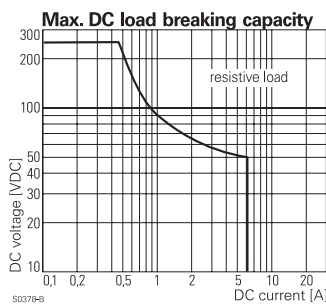

Coil Data
Coil voltage range 5 to 110VDC

Coil versions, DC-coil

Coil code	Rated voltage VDC	Operate voltage VDC	Release voltage VDC	Coil resistance Ω±10% ¹⁾	Rated coil power mW
005	5	3.8	0.5	35.7	700
006	6	4.5	0.6	51	706
009	9	6.8	0.9	116	698
012	12	9	1.2	206	699

Coil Data (continued)

Coil versions, DC-coil

Coil code	Rated voltage VDC	Operate voltage VDC	Release voltage VDC	Coil resistance Ω±10% ¹⁾	Rated coil power mW
015	15	11.3	1.5	321	701
018	18	13.5	1.8	483	671
021	21	16	2.1	630	700
024	24	18	2.4	823	700
036	36	27	3.6	1851	700
040	40	30	4.0	2286	700
048	48	36	4.8	3291 ¹⁾	700
060	60	45	6	5142 ¹⁾	700
080	85	63.8	8.5	9143 ¹⁾	790
110	110	83	11	17285 ¹⁾	700

¹⁾ Coil resistance ±12%.
All figures are given for coil without pre-energization, at ambient temperature +23°C.

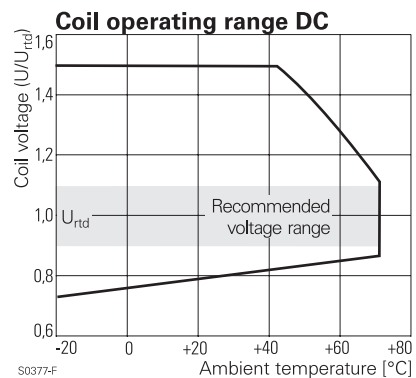

Insulation

Initial dielectric strength	
between open contacts	1500V _{rms}
between contact and coil	4000V _{rms}
between adjacent contacts	3000V _{rms}
Clearance/creepage	
between open contacts	microdisconnection
between contact and coil	≥8/8mm
between adjacent contacts	≥5.5/5.5mm
Insulation to EN 50178, type of insulation	
between contact and coil	reinforced
between adjacent contacts	reinforced

Force Guided Relay SR2M (Continued)

Other Data

Material compliance: EU RoHS/ELV, China RoHS, REACH, Halogen content refer to the Product Compliance Support Center at www.te.com/customersupport/rohssupportcenter

Ambient temperature	-25 to 70°C
Category of environmental Protection	RTIII
IEC 61 810	RTIII
Weight	20g
Resistance to soldering heat THT	
IEC 60068-2-20	260°C/5s
Packaging/unit	tube/20 pcs.

For more detailed information see product specification 2158001

PCB layout / terminal assignment

Bottom view on solder pins

2 form C, 2 CO contacts

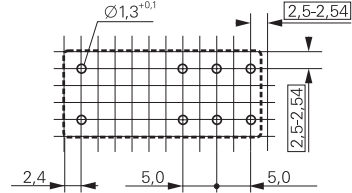

S0163-CO

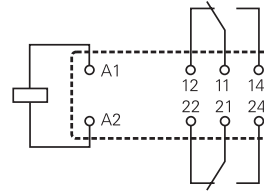

S0163-BJ

Dimensions

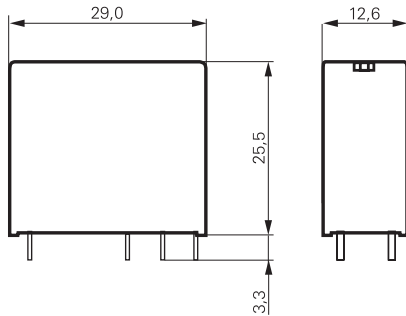

S0273-BB

1 form A + 1 form B contacts, 1 NO + 1 NC

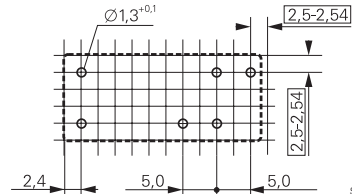

S0163_CU

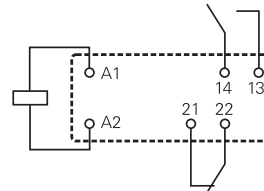

S0163-CV

Force Guided Relay SR2M (Continued)

Product code structure

Typical product code **V23047 -A1 012 -A 5 11**

Type V23047 Relay with force guided contacts SR2M
Version A1 standard
Coil Coil code: please refer to coil versions table (e.g. 024=24VDC)
Contact set A single contact
Contact material 5 AgNi
Contact configuration 01 2 form C contacts (2 CO) 11 1 form A + 1 form B contacts (1 NO + 1 NC)

Other types on request

Product code	Version	Cont. material	Contact arrangement	Coil	Part number
V23047-A1005-A501	Standard	AgNi	2 form C (CO)	5VDC	1393258-2
V23047-A1005-A511	wash tight		1 A + 1 B, (1 NO + 1 NC)		7-1415006-1
V23047-A1006-A501			2 form C (CO)	6VDC	3-1415011-1
V23047-A1006-A511			1 A + 1 B, (1 NO + 1 NC)		6-1415011-1
V23047-A1009-A501			2 form C (CO)	9VDC	1393258-3
V23047-A1009-A511			1 A + 1 B, (1 NO + 1 NC)		7-1415011-1
V23047-A1012-A501			2 form C (CO)	12VDC	1393258-4
V23047-A1012-A511			1 A + 1 B, (1 NO + 1 NC)		1393258-5
V23047-A1018-A501			2 form C (CO)	18VDC	1393258-8
V23047-A1018-A511			1 A + 1 B, (1 NO + 1 NC)		1393258-9
V23047-A1021-A501			2 form C (CO)	21VDC	1-1393258-1
V23047-A1021-A511			1 A + 1 B, (1 NO + 1 NC)		1-1393258-2
V23047-A1024-A501			2 form C (CO)	24VDC	1-1393258-5
V23047-A1024-A511			1 A + 1 B, (1 NO + 1 NC)		1-1393258-7
V23047-A1036-A501			2 form C (CO)	36VDC	2-1393258-0
V23047-A1036-A511			1 A + 1 B, (1 NO + 1 NC)		8-1415011-1
V23047-A1040-A501			2 form C (CO)	40VDC	2-1393258-1
V23047-A1040-A511			1 A + 1 B, (1 NO + 1 NC)		2-1393258-2
V23047-A1048-A501			2 form C (CO)	48VDC	3-1415006-1
V23047-A1048-A511			1 A + 1 B, (1 NO + 1 NC)		9-1415011-1
V23047-A1060-A511				60VDC	2-1393258-3
V23047-A1110-A501			2 form C (CO)	110VDC	1-1415012-1
V23047-A1110-A511			1 A + 1 B, (1 NO + 1 NC)		2-1415012-1