

E37411

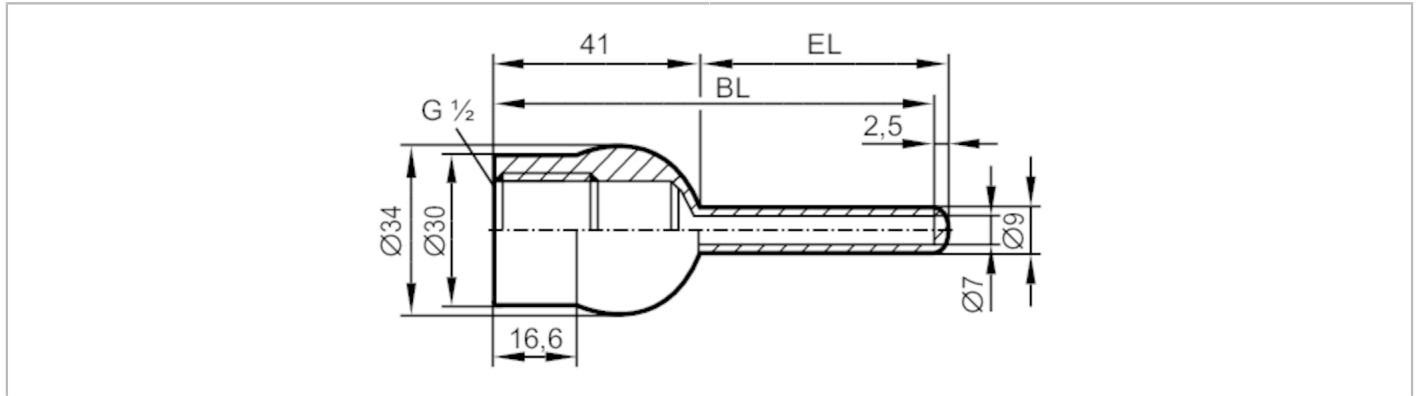

Welding thermowell for temperature sensors

THERMOWELL,D6/WELD-IN/G1/2 conical/L=50



EC 1935/2004 EHEDG Certified



Application	
Design	for temperature sensors EL = 50 mm
Pressure rating [bar]	300
Mechanical data	
Weight [g]	157.9
Materials	stainless steel (1.4404 / 316L)
Sensor connection	G 1/2 sealing cone Ø 6 mm
Process connection	welding adapter Ø 34 mm
Surface characteristics Ra/Rz of the wetted parts	≤ 0.6 / -
Installation length EL [mm]	49
Bore length BL [mm]	87
Remarks	
Pack quantity	1 pcs.