

DIMENSIONS (mm)

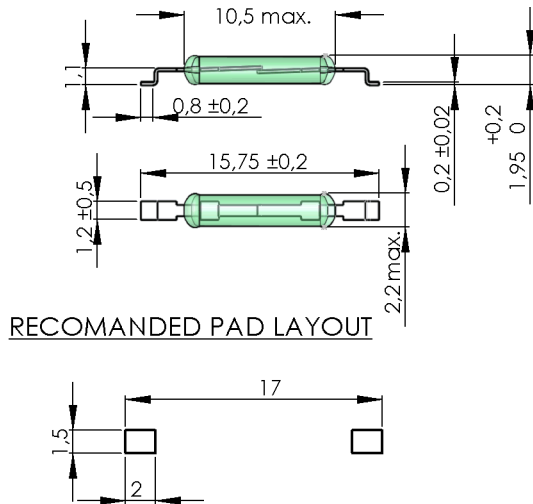

RECOMANDED PAD LAYOUT



TAPE AND REEL

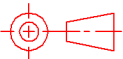
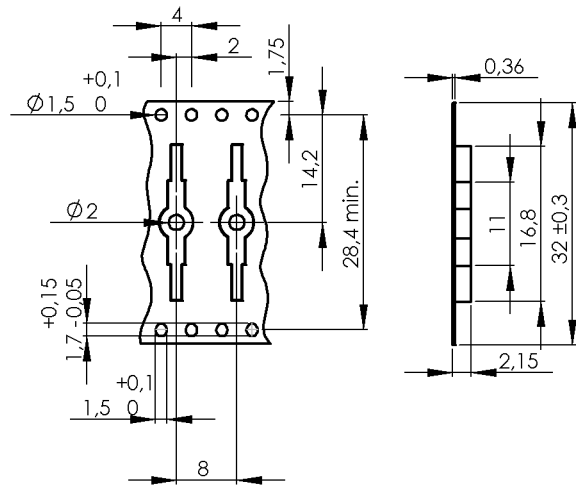

tolerances according to DIN ISO 2768 m

Magnetic properties	Conditions	Min	Typ	Max	Unit
Pull-In	at 20°C	29		55	
Test equipment		KMS-11 + AP51			
Pull-In in milliTesla (modified conta	MS150 - phys. caused tolerance +/- 0,1mT	1,3		2,3	mT
Test equipment		MS-150			

Contact data 35	Conditions	Min	Typ	Max	Unit
Contact - No.		35			
Contact-form		A - NO			
Contact rating	Any DC combination of V & A not to exceed their individual max.'s			15	W
Switching voltage (> 9 AT)	DC or Peak AC			200	V
Switching current	DC or Peak AC			1	A
Carry current	DC or Peak AC			1,25	A
Contact resistance static	Measured with 40% overdrive Start Value			150	mOhm
Breakdown voltage (10-30 AT)	according to IEC 255-5	220			VDC

Special Product Data	Conditions	Min	Typ	Max	Unit
Approval					

Environmental data	Conditions	Min	Typ	Max	Unit
Shock	1/2 sine wave duration 11ms			30	g
Vibration	from 10 - 2000 Hz			20	g
Operating temperature		-40		130	°C
Storage temperature		-55		130	°C
Washability		fully sealed			