

Positioning Bushings • for index bolts and index plungers

22110.0475



Product Description

Positioning bushings are suitable for index plungers and index bolts. Low wear thanks to hardened running ball.

Material

- Stainless steel, hardened

Drawing

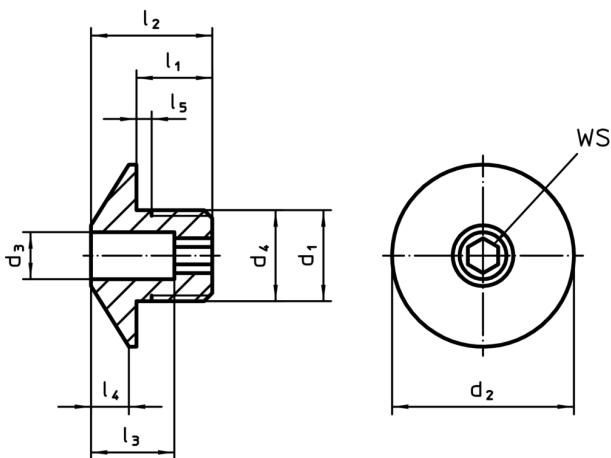

Order information

d ₁	d ₃ +0.1	d ₂	d ₄ -0.05	Dimensions					For pin [mm]	WS [mm]	 [g]	Art. No.
				l ₁	l ₂	l ₃	l ₄	l ₅ +0.5				
[mm]												
stainless steel												
M12 x 1,5	5.2	24	12	10	16	11	5	1.5	5	4	16	22110.0475

Application example

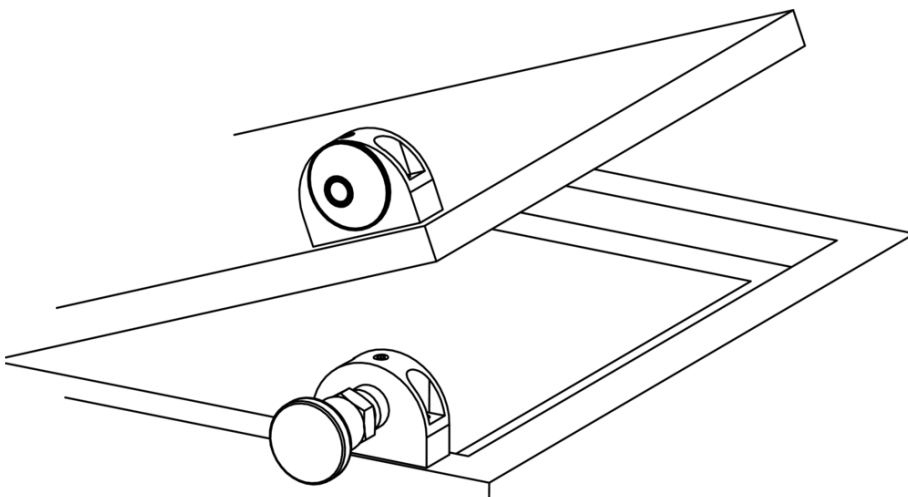

Compliance

RoHS compliant

Compliant according to Directive 2011/65/EU and Directive 2015/863

Does not contain SVHC substances

No SVHC substances with more than 0.1% w/w contained - SVHC list [REACH] as of 10.06.2022

Does not contain Proposition 65 substances

No Proposition 65 substances included
<https://www.P65Warnings.ca.gov/>

Free from Conflict Minerals

This product does not contain any substances designated as "conflict minerals" such as tantalum, tin, gold or tungsten from the Democratic Republic of Congo or adjacent countries.