

/ Evaluation Kit for Epishine Light Energy Harvesting Modules

/ Description

This evaluation kit is designed to show how Epishine Light Energy Harvesting (LEH) modules can power indoor wireless low-power devices that are normally powered by batteries. It combines Epishine LEH modules with a supercapacitor as an energy buffer and intelligent charging management to support various output voltages and energy storage solutions. It can even use an external primary battery as a backup. The evaluation kit can deliver sufficient output current to power most low-power radios such as BLE, Zigbee, LoRa and similar. It is thin and flexible to showcase the unique product integration and design possibilities of Epishine light energy harvesting modules.

/ Features

- Selectable output voltage ranging from 1.8V to 3.3V in 0.1V steps
- Up to 300mA output current
- Optimized for indoor use (-20°C to 40°C / 0-85%RH) with illumination intensities ranging from 20 to 1000lux
- Includes a 6-cell 50x50mm module
- Includes a supercapacitor for energy storage, which can also be reconfigured to charge a rechargeable battery
- Can be used by itself or together with a primary battery to backup when supercapacitor storage is empty

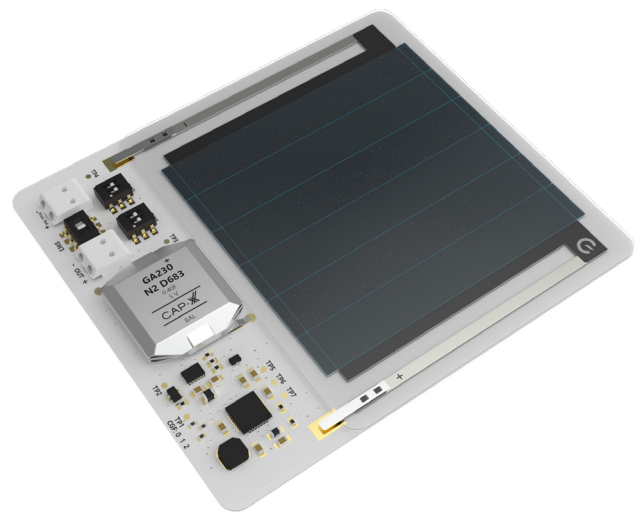

| Electrical specifications | | |
|--------------------------------|-----------------|---|
| Output Voltage | 1.8V - 3.3V | Selectable in 100mV steps |
| Output Current | Up to 300mA | Continuous while energy in storage element |
| Electrical Energy Storage | 1.9Ws - 3.4Ws | 1.9Ws at 3,3V output voltage and 3,4Ws at 1.8V output voltage |
| Light Energy Harvesting Module | LEH3_50x50_6_10 | Can work with any Epishine 4 or 6-cell LEH modules |
| Electrical Energy Storage | GA230F | 400mF, CAP-XX |
| Energy Harvesting IC | AEM10941 | e-Peas |
| Primary Battery Voltage | 1.2V - 5.5V | Alkaline primary batteries |
| Output DC Regulator | TPS62740 | Texas Instruments |



/ Function Description

This evaluation kit is intended for indoor use and under low-light conditions (i.e. less than 1000lux). It comes with all parts necessary to test the replacement of a battery in a wireless low-power device, such as sensors or IoT devices. In short, the Epishine LEH module powers an e-peas energy harvesting circuit that manages the charging of the supercapacitor. An overview can be found in the block diagram below.

With an empty super capacitor, the circuit is able to start up with an LEH input voltage of as low as 380mV. A boost converter increases the input voltage and charges the supercapacitor.

The boost converter is regulated by an internal Maximum Power Point Tracking module to optimize charging by measuring the input open circuit voltage from the LEH module approximately every 5 seconds. The maximum charge voltage of the capacitor is limited to 4.5V.

When the supercapacitor reaches a voltage of 3.9V, the status pin TP5 status goes high and enables the TPS 62740 buck regulator and output the desired voltage. This is set with the switches SW1 and SW2. The output will switch off when the supercapacitor discharges close to the selected output voltage.

To maintain output when the supercapacitor is discharged below the desired output voltage, a battery can be connected to the backup battery terminal. This feature can be turned on with the switch SW3.

Note that the backup battery cannot “kick-start” the energy harvesting IC if the super capacitor is empty. The harvesting IC needs to be supplied with at least 380mV by the light cell to start correctly.

Typical output characteristics during charging and discharging with different configurations can be found on page 4.

For details see e-peas homepage: e-peas.com.

/ Block diagram

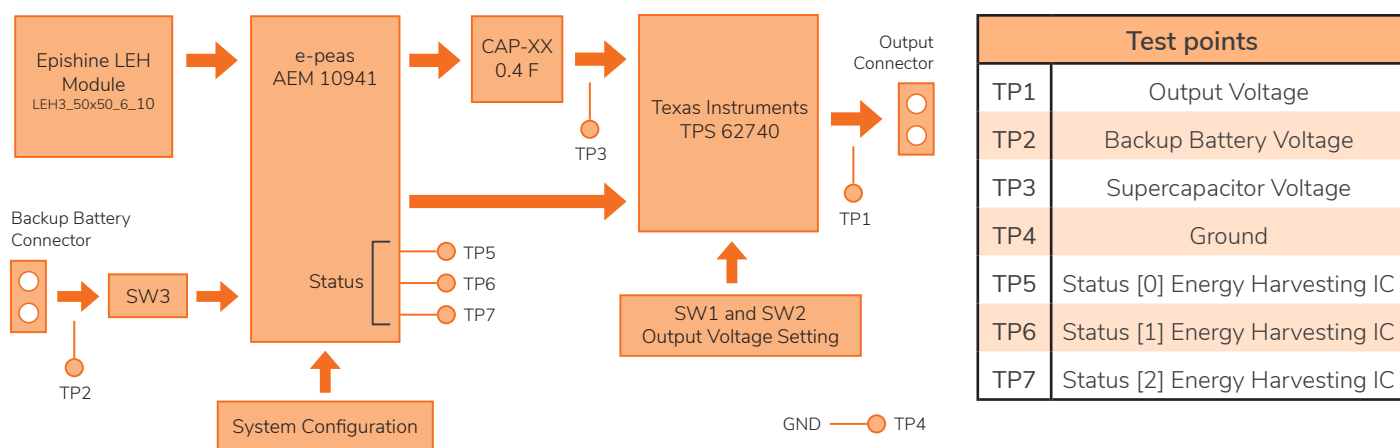

| Status pins ePeas PMIC | |
|------------------------|--|
| Status [0] | Logic output. Asserted when the LDOs can be enabled |
| Status [1] | Logic output. Asserted if the battery voltage falls below Vovdis or if the AEM is taking energy from prim. battery |
| Status [2] | Logic output. Asserted when the AEM performs a MPP evaluation |



/ Instructions of Use

1. Set output voltage with switches SW1 and SW2 according to the table below "Output Voltage Setting".
2. Verify the output voltage by measuring at test points TP1 and TP4 (GND).
 - If no output voltage is measured the supercapacitor may not be charged adequately. Place the device in light to charge the supercapacitor. The time to fully charge the supercapacitor at 500lux illuminance is approximately 5 hours. While a higher light intensity charges the supercapacitor more quickly, it is not recommended to use the evaluation kit in environments exceeding more than 1000lux for an extended period of time.
 - The supercapacitor voltage can be measured between test points TP3 and TP4 (GND), it needs to be above 3.9V to start.
3. If you want to use the primary backup feature, set switch SW3 according to below table Primary Battery Setting and connect a battery to the battery terminal.
 Note: When using the primary battery backup function, do not remove the battery or toggle SW3 while the supercapacitor is being charged from the battery. Doing so will cause the evaluation kit to stop working properly. If that happens, reconnect the battery and toggle SW3 back to backup mode and wait for the supercapacitor to fully charge (>3.9V at TP3) or restart the evaluation kit by discharging the supercapacitor.
4. Connect the device that you wish to test with the Epishine evaluation kit to the output terminal.

/ Settings

| Output Voltage Settings | | |
|-------------------------|-----|-----|
| Voltage (V) | SW2 | SW1 |
| 1.8 | 00 | 00 |
| 1.9 | 00 | 01 |
| 2.0 | 00 | 10 |
| 2.1 | 00 | 11 |
| 2.2 | 01 | 00 |
| 2.3 | 01 | 01 |
| 2.4 | 01 | 10 |
| 2.5 | 01 | 11 |
| 2.6 | 10 | 00 |
| 2.7 | 10 | 01 |
| 2.8 | 10 | 10 |
| 2.9 | 10 | 11 |
| 3.0 | 11 | 00 |
| 3.1 | 11 | 01 |
| 3.2 | 11 | 10 |
| 3.3 | 11 | 11 |

| Primary battery settings | |
|--------------------------|--|
| No battery | Rocker pointing away from battery terminal |
| Use battery backup | Rocker pointing towards battery terminal |

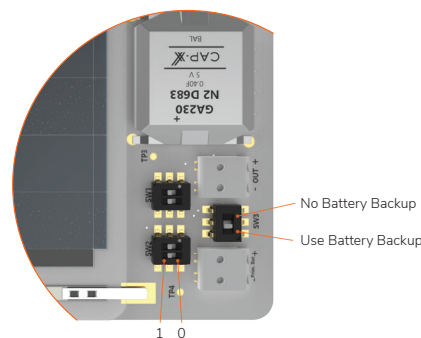
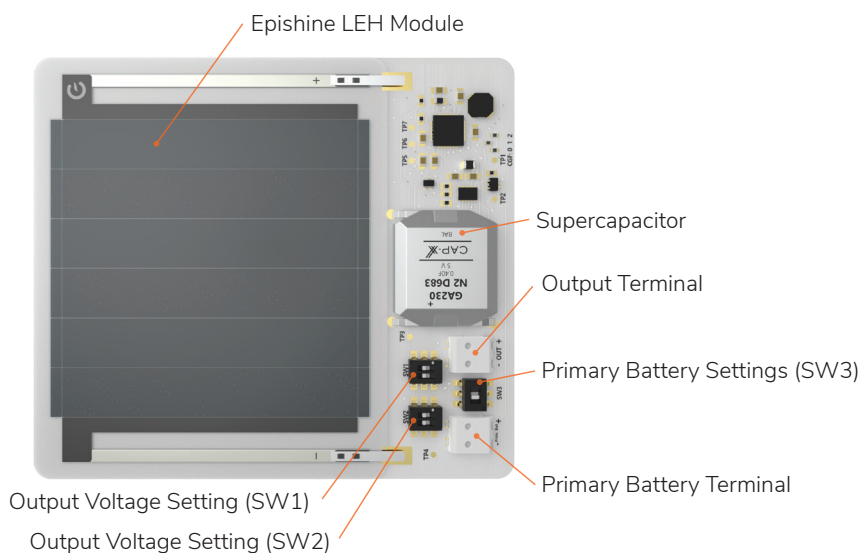

/ Output Characteristics

Charge/Discharge @ 1.8V Output

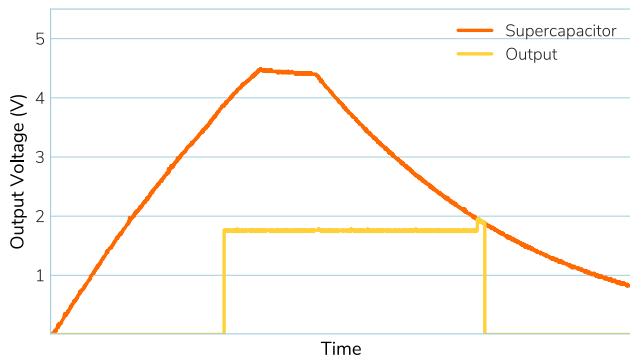

Charge/Discharge @ 3.3V Output

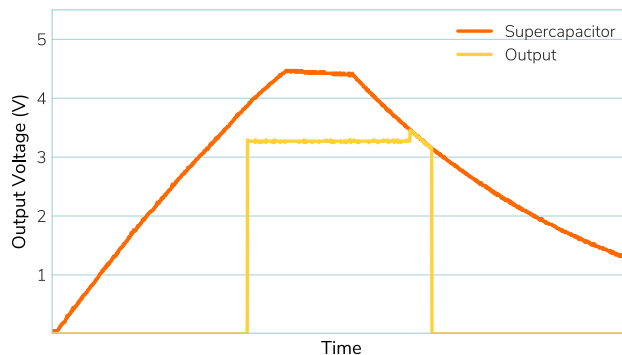

Charge/Discharge @ 3.3V Output with Battery Backup

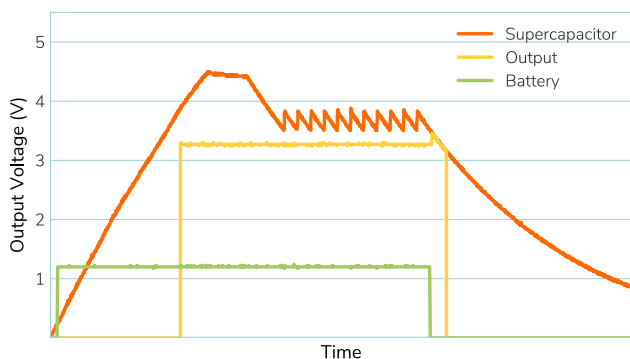

Mechanical Dimensions

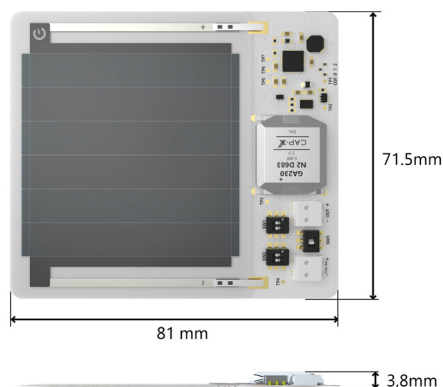

/ Terms of Use

This evaluation kit is intended to be used in a research and development setting to facilitate feasibility evaluation, experimentation, or scientific analysis of Epishine LEH modules.

This evaluation kit is not intended for consumer or household use. It may not be sold, sub-licensed, leased, rented, loaned, assigned, or otherwise distributed for commercial purposes by users, in whole or in part, or used in any finished product or production system.

A primary battery could be connected to the Prim Bat. input. The battery should have a voltage in the range of 1.2V to 5.5V and should be of alkaline type. Batteries are not included in the evaluation kit and must be handled with the user's discretion.



This symbol on the product and / or accompanying documents means that used electrical and electronic equipment (WEEE) should not be mixed with general household waste. For proper treatment, recovery and recycling, please take this product to designated collection points where it will be accepted free of charge.



CAN ICES3(B)/NMB3(B)

