

PS2P-CON

Touchless Concentric Rotary Hall-Effect Position Sensor

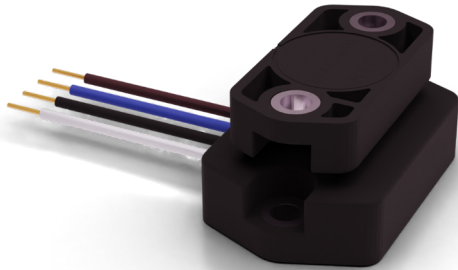

KEY FEATURES

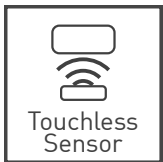

True touchless operation

Without any internal or external gears or linkages the sensor is easily assembled and calibrated and free from wear and tear over lifetime.



Unlimited mechanical life

The separation of electronics and magnet module allows for a virtually unlimited lifetime independent of number of revolutions.



Made for harsh environments

IP69K sealing, high operating temperature range as well as shock and vibration resistance allow the use in the most demanding environments.

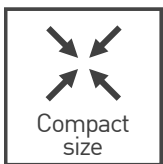

Compact and low profile package

Without the need for a shaft the sensor is provided in an exceptionally compact and low profile package that fits in space constrained applications.



Adaptable to your requirements

Custom mechanical design, programmable transfer function and switch outputs as well as different output protocols and redundancy levels available.

DESCRIPTION

Piher Sensing Systems' PS2P-CON rotary position sensor delivers true touchless sensing for harsh industrial and vehicle environments in a low profile and robust magnetic design.

Magnet and sensor module are placed in separate housings without the need for any gears, bearings or linkages and can be placed anywhere on the pivoting shaft. This allows for easy mounting, thereby delivering additional cost reduction on the production line. Furthermore, without wear and tear of radial forces product reliability and lifetime are increased significantly.

The PS2P-CON measures changes in angular position relative to the sensor by detecting the movement of a sinusoidal magnetized magnet that is located in a separate housing and is only sensitive to the flux density co-planar with the IC surface.

The PS2P series is complemented by touchless linear (PS2P-LIN) and variable air gap arc (PS2P-ARC) position sensors. All sensors of the series are absolute sensors and will deliver the same level of precision and stability throughout their lifetime as on the first day they are installed - despite extremes of vibration, shock, temperature and contamination.

APPLICATIONS

Off-Highway

- ▶ Bucket position
- ▶ Pedal / throttle position
- ▶ Hitch position
- ▶ Bus suspension / kneeling position

Automotive

- ▶ Gear selector
- ▶ Transmission systems

Home & Building Automation

- ▶ HVAC damper actuator monitoring

Marine

- ▶ Trim / tilt position

Industrial

- ▶ Robotic / hydraulic arm position
- ▶ Valve monitoring
- ▶ IoT modules
- ▶ Vacuum circuit breaker monitoring

PS2P-CON

Touchless Concentric Rotary Hall-Effect Position Sensor

MECHANICAL SPECIFICATIONS

Life	Virtually unlimited
Nominal air gap	3mm between plastic parts
Maximum air gap	5mm, higher on request
Maximum allowed radial offset	±3mm

ELECTRICAL SPECIFICATIONS

Linearity ¹	±1% absolute (±0.5% upon request)
Angular range	Programmable from 15 to 360 degrees
Output protocol	Analog (Ratiometric), PWM Serial Protocol (SPI) upon request
Output	Simple Redundant Full-redundant
Switch Output	On request
Resolution	Analog, PWM SPI Up to 12 bit Up to 14 bit
Supply voltage ²	5V ±10% 7V to 15V
Supply current	Single version Redundant version Typ 8.5 mA Typ 17 mA
Voltage protection	±10V
Self-diagnostic features	yes

¹ Ferromagnetic materials close to the sensor (i.e. shaft, mounting surface) may affect the sensor's linearity.

² Voltages up to 25V possible on request.

ENVIRONMENTAL SPECIFICATIONS

Operating and storage temperature ¹	-40° to +125°C
Shock	50g
Vibration	5Hz to 2000 Hz; 20g; A _{max} 0,75 mm
Sealing ²	IP67, IP69K
Approval	CE ²

¹ Other specifications available

² CE-approval applies to analogic models.

EMI/EMC Testing

Characteristic	Standard	Level
Radiated emissions	CISPR 16-2-3 class B	30 MHz to 230 MHz, max. 30dB (µV/m) 230 MHz to 1000 MHz, max. 37dB (µV/m)
ESD on housing and connections	EN 61000-4-2:2009	±4 kV contact ±8 kV air
Burst (on supply lines / signal lines)	EN 61000-4-4:2012	±1kV
Surge (on supply lines / signal lines)	EN 61000-4-5:2014	±1kV
Immunity HF radiated (80 ... 2000 MHz)	EN 61000-4-3:2006	10 V/m
Immunity HF conducted (0,15 ... 80MHz)	EN 61000-4-6:2014	10 Vemk
Immunity magnetic field (50 Hz)	EN 61000-4-8:2010	30 A/m

PS2P-CON

Touchless Concentric Rotary Hall-Effect Position Sensor

DIMENSIONS (MM)

PS2P-CON-CE-M001

PS2P-CON-CE-M006

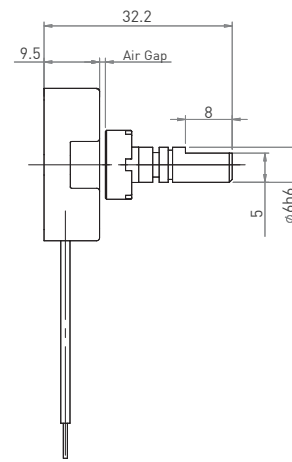
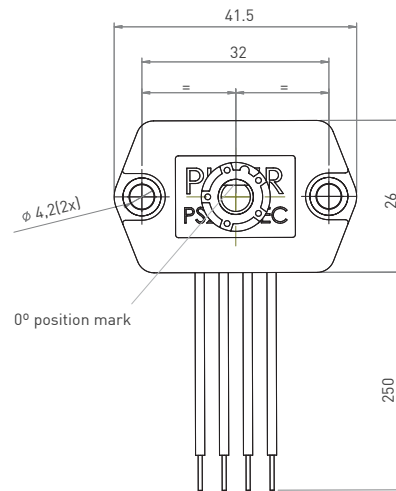
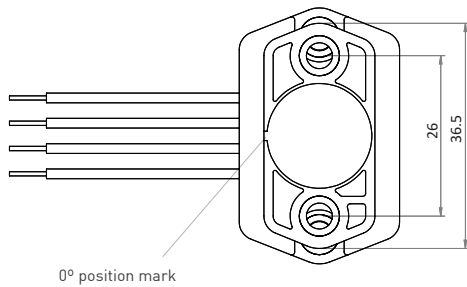
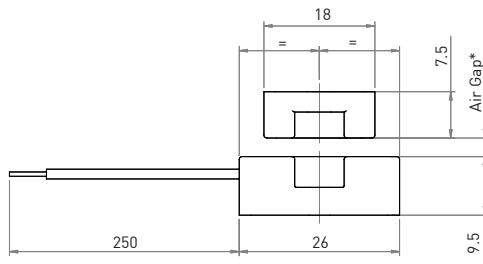
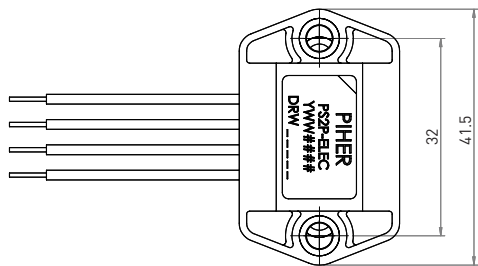
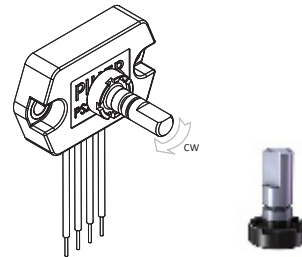
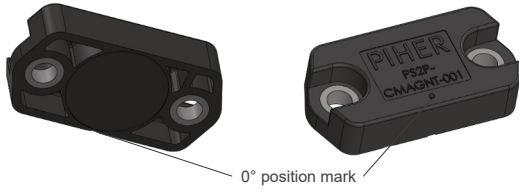

Download the STEP file here:
<https://piher.net/piher/?p=932>

Instructions
of use available at
www.piher.net

Magnet shown on 0° position. Drawings may not be to scale. Number and function of wires pictured in this datasheet may vary according to output configuration.

PS2P-CON

Touchless Concentric Rotary Hall-Effect Position Sensor

HOW TO ORDER (Example: PS2P-CON-CE-M001-1A0-C0000-ERA360-05)

Simple Output

PS2P-CON-CE	-	---	-	1	-	---	-	C	---	-	ERA	---	-	---	-	---
Series	Magnet Model	Type	Output ¹	Output function ²	Electric rotational angle ³	Voltage supply ⁴	PWM Frequency Hz ⁵									
	M001 M006	1 = simple	A0 = analogic P0 = PWM	C0000 C0001	ERA040 ERA041 ... ERA360	05 = 5V ±10% RE = 7V-15V	[empty] = 200Hz F100 = 100Hz F101 = 101Hz ... F999 = 999Hz									

Redundant output

PS2P-CON-CE	-	---	-	2	-	---	-	C	---	-	ERA	---	-	---	-	---	---
Series	Magnet Model	Type	Output ¹	Output function ²	Electric rotational angle ³	Voltage supply ⁴	PWM Frequency Hz (1) ⁵	PWM Frequency Hz (1) ⁵									
	M001 M006	2 = redundant	AA = analogic PP = PWM	C0002 C0003	ERA040 ERA041 ... ERA360	05 = 5V ±10% RE = 7V-15V	[empty] = 200Hz F100 = 100Hz F101 = 101Hz ... F999 = 999Hz	[empty] = 200Hz F100 = 100Hz F101 = 101Hz ... F999 = 999Hz									

Full-redundant output

PS2P-CON-CE	-	---	-	3	-	---	-	C	---	-	ERA	---	-	05	-	---	---
Series	Magnet Model	Type	Output ¹	Output function ²	Electric rotational angle ³	Voltage supply	PWM Frequency Hz (1) ⁵	PWM Frequency Hz (1) ⁵									
	M001 M006	3 = full-redundant	AA = analogic PP = PWM	C0002 C0003	ERA040 ERA041 ... ERA360	05 = 5V ±10%	[empty] = 200Hz F100 = 100Hz F101 = 101Hz ... F999 = 999Hz	[empty] = 200Hz F100 = 100Hz F101 = 101Hz ... F999 = 999Hz									

1 The analog output is ratiometric, proportional:

- for supply voltage "5V" to input voltage;
- for supply voltage "RE" to 5V.

2 Other output functions available, please check availability. Enter CXXXX as long as the new output function is not defined.

3 Models with ERA < 40° available on request

4 Voltages up to 25V possible on request.

5 Leave empty if not applicable. Default frequency is 200 Hz

EXAMPLE OUTPUT FUNCTIONS

C0000 (simple)

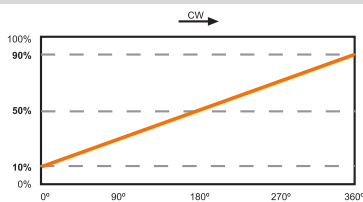

C0001 (simple)

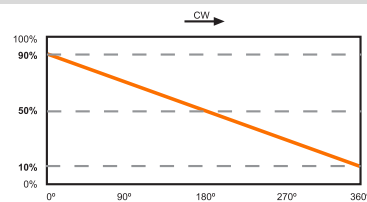

C0002 (redundant)

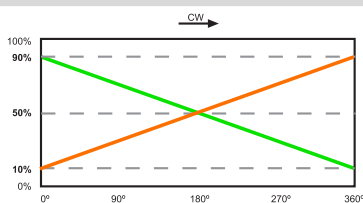

C0003 (redundant)

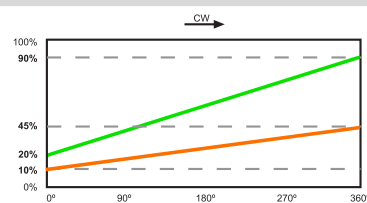

PS2P-CON

Touchless Concentric Rotary Hall-Effect Position Sensor

OUTPUT VOLTAGE DEPENDING ON MAGNET POSITION

PS2P-CON-CE-M006-1A0-C0000-ERA360-05

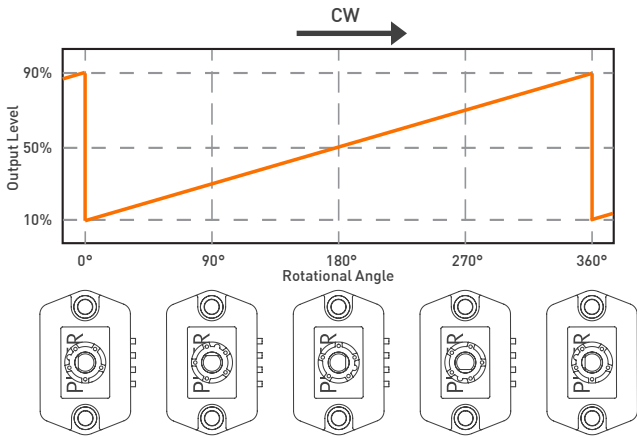

PS2P-CON-CE-M001-1A0-C0007-ERA180-05

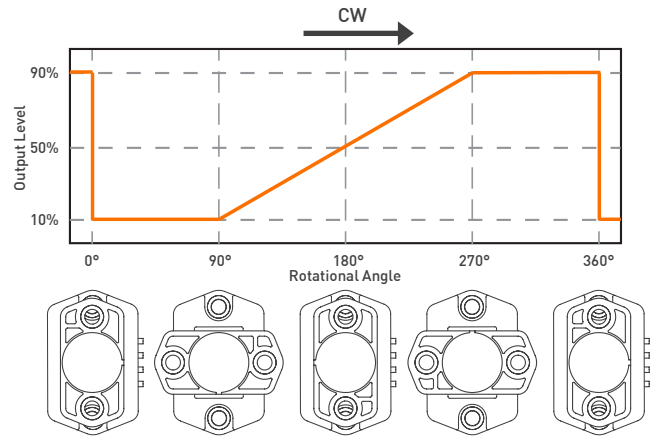

Custom output functions with up to 4 programmable points on request.

OUR ADVANTAGE

- ▶ Leading-edge innovative position sensing solutions
 - ▷ Contactless (Hall-effect and Inductive Technology)
 - ▷ Contacting (Potentiometers, Printed Electronics)
- ▶ Engineering design-in support
- ▶ All our products can be customized to fit target application and customer requirement
- ▶ Capability to move seamlessly from development to true high-volume production
- ▶ A global footprint with global engineering and commercial support
- ▶ One-stop shop not limited to position sensors (temperature, pressure, gas,...) through group collaboration
- ▶ Flexibility and entrepreneurship of a medium-sized company with the backing of Amphenol Corporation



Please always use the latest updated datasheets and 3D models published on our website.

Disclaimer:

The product information in this catalog is for reference purposes. Please consult for the most up to date and accurate design information. Piher Sensors & Controls S.A., its affiliates, agents, and employees, and all persons acting on its or their behalf (collectively, "Piher"), disclaim any and all liability for any errors, inaccuracies or incompleteness contained herein or in any other disclosure relating to any product described herein. Piher disclaims any and all liability arising out of the use or application of any product described herein or of any information provided herein to the maximum extent permitted by law. The product specifications do not expand or otherwise modify Piher's terms and conditions of sale, including but not limited to the warranty expressed therein, which apply to these products. No license, express or implied, by estoppel or otherwise, to any intellectual property rights is granted by this document or by any conduct of Piher. The products shown herein are not designed for use in medical, life-saving, or life-sustaining applications unless otherwise expressly indicated. Customers using or selling Piher products not expressly indicated for use in such applications do so entirely at their own risk and agree to fully indemnify Piher for any damages arising or resulting from such use or sale. Please contact authorized Piher personnel to obtain written terms and conditions regarding products designed for such applications. Product names and markings noted herein may be trademarks of their respective owners. Information contained in and/or attached to this catalog may be subject to export control regulations of the European Community, USA, or other countries. Each recipient of this document is responsible to ensure that usage and/or transfer of any information contained in this document complies with all relevant export control regulations. If you are in any doubt about the export control restrictions that apply to this information, please contact the sender immediately. For any Piher Exports, Note: All products / technologies are EAR99 Classified commodities. Exports from the United States are in accordance with the Export Administration Regulations. Diversion contrary to US law is prohibited.

CONTACT

Piher Sensing Systems
 Polígono Industrial Municipal
 Vial T2, N°22
 31500 Tudela
 Spain

sales@piher.net

Europe: +34 948 820 450
Americas: +1 636 251 0855
Asia Pacific: +65 9641 8886
India: +91 9538 686 586

Rev-10032022 © 2022 Piher Sensors & Controls S.A.