



Think Automation and beyond...

Interlock Switches with Solenoid
HS1T 2-Contact/4-Contact

Supporting safety for advancing technology

Slim interlock switches with 5000N locking force

HS1T



Interlock switches with 5000N locking force

Locking force of more than 5000N (40mm-wide slim model)

Smallest size in the industry (*1)

Greatly downsized from IDEC's HS1L interlock switches.

*1) Based on IDEC research (as of March, 2019)

Downsized
Volume
Approx. **70%** less

Conventional (HS1L): Volume 715 cm³
Locking force 3000N

HS1T: Volume 229 cm³
Locking force 5000N

All dimensions in mm.

The head can be rotated to allow the actuator entry direction to be changed easily

- Head rotating structure. Can be rotated without removing the head.
- Prevents invalid operation. (On usual interlock switches, the NC contact closes when the head is removed)

HS1T

- 1 Turn the flathead screwdriver in the direction shown above until the head stopper screw stops and is lifted up.
- 2 Rotate the head to the desired position.
- 3 Align the Δ marks indicated on the head and body and tighten the head stopper screw.

Change orientation of the head in 3 easy steps

Conventional IDEC interlock switches (HS5L)

- 1 Loosen the four screws using a cross point screwdriver.
- 2 Remove the head.
- 3 Attach to the desired position.
- 4 Tighten the four screws.

Many screws ...



Lock status can be identified from the front – Rear unlock mechanical indicator (First in the industry) (*1)

Mechanical indicator function allows the lock status to be easily identified from the front while the rear unlock mechanical indicator is pressed.

Note: Interlock switches with rear unlock mechanical indicator function only.

*1) Based on IDEC research (as of March, 2019).

Conventional (HS5L)

In conventional models, because the lock status cannot be identified from the front, the system cannot be restarted when the safety circuit is on. Therefore, it is necessary to find out which safety circuit is on.

If HS1T is used

Before unlock

After unlock

The lock status can be easily identified from the front even when the lock is released.

Energy efficient 200mA solenoid consumption

Because the solenoid current for locking operation is 200mA, the solenoid can be activated without using a relay.

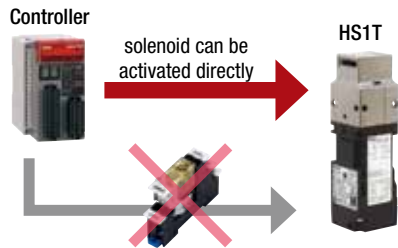

Rear unlocking button

Door lock can be unlocked inside the barrier by a worker left inside a hazardous area.

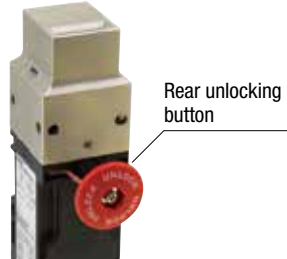

Spring clamp terminals

Spring clamp terminals offer excellent vibration resistance, preventing wires from loosening. No need for additional tightening.

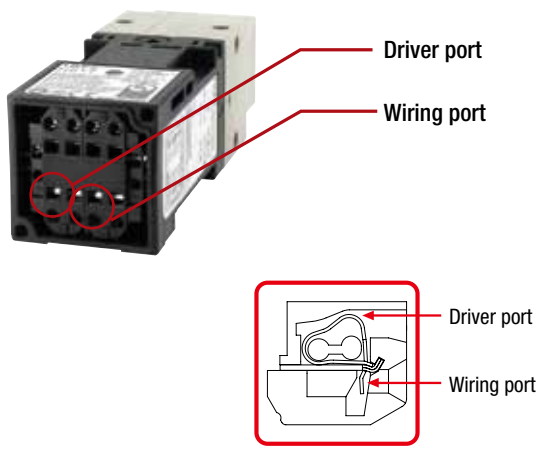

Side-conduit model

Cables can be connected to the right, left, or bottom (for straight cable orientation) of the terminal cover. Long marking tubes can be used on the wiring cables.

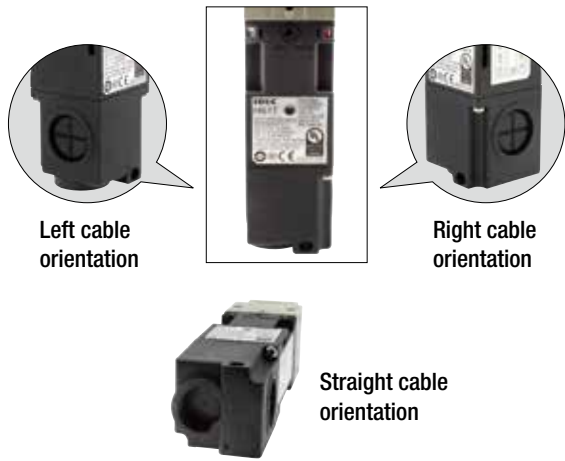

HS1T Interlock Switches with Solenoid

Ideal for use on large doors and large equipment requiring strong locking force

- Smallest in the industry with 5000N locking force. (*1)
- Rear unlock mechanical indicator allows the lock status to be identified from the front and back. (First in the industry) (*1)
- Head rotating function enables the actuator entry direction to be changed easily.
- Side-conduit model available.
- Two- and four-contact models available.
- Spring clamp terminal prevents loosening of wires.
- Energy efficient 200mA solenoid consumption.
- Solenoid lock and spring lock models available.
- Mechanical durability: 2,000,000 operations

*1) Based on IDEC research (as of March, 2019)



Specifications

Applicable Standards	EN ISO / ISO14119, IEC60947-5-1 (pending), EN60947-5-1 (TÜV approval), GS-ET-19 (TÜV approval), UL508 (UL Listing approval), CSA C22.2 No.14 (c-UL Listing approval), GB/T 14048. 5 (CCC pending) IEC60204-1/EN60204-1
Type and Coded level	Type 2 low level coded interlocking device (ISO14119)
Operating Temperature	-25 to + 55°C (no freezing)
Relative Humidity	20 to 95% (no condensation)
Storage Temperature	-40 to +80°C (no freezing)
Pollution Degree	3 (contacts: 2)
Impulse Withstand Voltage	2.5kV (between LED, solenoid and grounding: 0.5kV)
Insulation Resistance (500V DC megger)	Between live and dead metal parts: 100MΩ min. Between terminals of different poles: 100MΩ min.
Electric Shock Protection	Class II (IEC61140)
Degree of Protection	IP67 (IEC60529) Type 4X Indoor Use Only
Shock Resistance	Operating extremes: 100m/s ² (10G), Damage limits: 1000m/s ² (100G)
Vibration Resistance	Operating extremes: 10 to 55Hz, amplitude 0.35 min. Damage limits: 30Hz, amplitude 1.5mm min.
Actuator Operating Speed	0.05 to 1.0m/s
Direct Opening Travel	12mm min.
Direct Opening Force	120N
Actuator Retention Force (*1)	Fzh = 5,000N min. (GS-ET-19) (*3)
Operating Frequency	900 operations per hour
Rear Unlock Button Mechanical Durability	3,000 times min. (HS1T-□L)
Mechanical Durability	2,000,000 times min.
Electrical Durability	100,000 times min. (AC-15 0.75A/250V) 2,000,000 times min. (24V AC/DC, 100mA) (Operating Frequency: 900 operations per hour)
Conditional Short-circuit Current	50A (250V) (*2)
Cable	0.3mm ² min. and 1.5mm ² max. or AWG22 min. to AWG16 max. stranded wire or solid wire
Weight (approx.)	450g

*1) See page 17 regarding actuator retention force.

*2) Use 250V/10A fast-blow fuse for short-circuit protection.

*3) The actuator retention force of HS1T is 5000N at static load.

Make sure that a force exceeding the above specification is not applied. In the event where the actuator retention force might exceed the expected load, add a system that can detect the opening of the door and stops the machine, such as adding another safety switch without lock (such as HS5D) or a sensor.

Additional Marking to indicate Lock Monitoring

This new international marking for lock monitoring is described in clause 9.2.1 of ISO14119 and is used to satisfy the requirements shown below.

5.7.1 General requirements

5.7.2.2 Locking monitoring

The lock monitor circuit (contacts) with this marking can monitor both the status of protective doors and locking function. (locking monitor contact [circuits] opens when the protective door is closed and locked)

Both HS1T spring lock and solenoid lock models have marking for lock monitoring. Note that solenoid lock models can be used in applications where lock for safety purpose is found unnecessary after a risk assessment, e.g. locking is needed for purposes such as in production process.

Ratings

Contact Ratings

Rated Insulation Voltage (Ui)	250V (between LED, solenoid and grounding: 30V)				
Rated Current (Ith)	2.5A				
Rated Voltage (Ue)	30V	125V	250V		
Rated Current (Ie) *	AC	Resistive Load (AC-12)	—	2.5A	1.5A
		Inductive Load (AC-15)	—	1.5A	0.75A
	DC	Resistive Load (DC-12)	2.0A	0.4A	0.2A
		Inductive Load (DC-13)	1.0A	0.22A	0.1A

• Minimum applicable load (reference): 3V AC/DC, 5mA
(Applicable range may vary with operating conditions and load types.)

* UL, c-UL rating: Pilot Duty AC 0.75A/250V, Pilot Duty DC 1.0A/30V

TÜV rating: AC-15 0.75A/250V, DC-13 1.0A/30V

CCC rating: AC-15 0.75A/250V, DC-13 1.0A/30V (pending)

Solenoid











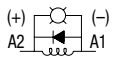







Locking Mechanism	Spring Lock	Solenoid Lock
Rated Voltage	100% duty cycle at 24V DC	
Rated Current	200mA (initial value)	
Coil Resistance	120Ω (at 20°C)	
Pickup Voltage	Rated voltage × 85% max. (at 20°C)	
Dropout Voltage	Rated voltage × 10% min. (at 20°C)	
Maximum Continuous Applicable Voltage	Rated voltage × 110%	
Maximum Continuous Applicable Time	Continuous	
Insulation Class	Class F	

Indicator

Rated Voltage	24V DC 100% duty cycle
Rated Current	10mA
Light Source	LED
Illumination Color	G (Green)

4-Contact (Spring Lock/Solenoid Lock)

Package Quantity: 1

Circuit Code	Contact Configuration	Gland Port Size	Spring lock	Solenoid	
			Part No.		
VA	<p>Door Monitor (Actuator inserted)</p>  <p>Door Monitor: 1NC,1NO</p> <p>Monitor Circuit: ⊖ 11 12</p> <p>Monitor Circuit: 23 24</p> <p>Monitor Circuit:</p>	<p>Lock Monitor</p> <p>(Spring lock → Solenoid OFF) (Solenoid lock → Solenoid ON)</p>  <p>Lock Monitor Circuit: 1NC,1NO</p> <p>41 42  (Note)</p> <p>53 54</p>	M20	HS1T-VA44ZM-G	HS1T-VA7Y4ZM-G
			M20	HS1T-VA44ZSM-G (side-conduit model)	HS1T-VA7Y4ZSM-G (side-conduit model)
VB	<p>Door Monitor: 1NC,1NO</p> <p>Monitor Circuit: ⊖ 11 12</p> <p>Monitor Circuit: 23 24</p> <p>Monitor Circuit:</p>	<p>Lock Monitor Circuit: 2NC</p> <p>41 42  (Note)</p> <p>51 52  (Note)</p>	M20	HS1T-VB44ZM-G	HS1T-VB7Y4ZM-G
			M20	HS1T-VC44ZM-G	HS1T-VC7Y4ZM-G
VC	<p>Door Monitor: 2NC</p> <p>Monitor Circuit: ⊖ 11 12</p> <p>Monitor Circuit: ⊖ 21 22</p> <p>Monitor Circuit:</p>	<p>Lock Monitor Circuit: 1NC,1NO</p> <p>41 42  (Note)</p> <p>53 54</p>	M20	HS1T-VC44ZM-G	HS1T-VC7Y4ZM-G
			M20	HS1T-VC44ZSM-G (side-conduit model)	HS1T-VC7Y4ZSM-G (side-conduit model)
VD	<p>Door Monitor: 2NC</p> <p>Monitor Circuit: ⊖ 11 12</p> <p>Monitor Circuit: ⊖ 21 22</p> <p>Monitor Circuit:</p>	<p>Lock Monitor Circuit: 2NC</p> <p>41 42  (Note)</p> <p>51 52  (Note)</p>	M20	HS1T-VD44ZM-G	HS1T-VD7Y4ZM-G
			M20	HS1T-VD44ZSM-G (side-conduit model)	HS1T-VD7Y4ZSM-G (side-conduit model)
VF	<p>Door Monitor: 3NC</p> <p>Monitor Circuit: ⊖ 11 12</p> <p>Monitor Circuit: ⊖ 21 22</p> <p>Monitor Circuit: ⊖ 31 32</p>	<p>Lock Monitor Circuit: 1NC</p> <p>41 42  (Note)</p>	M20	HS1T-VF44ZM-G	HS1T-VF7Y4ZM-G
			M20	HS1T-VF44ZSM-G (side-conduit model)	HS1T-VF7Y4ZSM-G (side-conduit model)
VG	<p>Door Monitor: 2NC,1NO</p> <p>Monitor Circuit: ⊖ 11 12</p> <p>Monitor Circuit: ⊖ 21 22</p> <p>Monitor Circuit: 33 34</p>	<p>Lock Monitor Circuit: 1NC</p> <p>41 42  (Note)</p>	M20	HS1T-VG44ZM-G	HS1T-VG7Y4ZM-G
			M20	HS1T-VG44ZSM-G (side-conduit model)	HS1T-VG7Y4ZSM-G (side-conduit model)
VH	<p>Door Monitor: 1NC</p> <p>Monitor Circuit: ⊖ 11 12</p> <p>Monitor Circuit:</p> <p>Monitor Circuit:</p>	<p>Lock Monitor Circuit: 3NC</p> <p>41 42  (Note)</p> <p>51 52  (Note)</p> <p>61 62  (Note)</p>	M20	HS1T-VH44ZM-G	HS1T-VH7Y4ZM-G
			M20	HS1T-VJ44ZM-G	HS1T-VJ7Y4ZM-G
VJ	<p>Door Monitor: 1NC</p> <p>Monitor Circuit: ⊖ 11 12</p> <p>Monitor Circuit:</p> <p>Monitor Circuit:</p>	<p>Lock Monitor Circuit: 2NC, 1NO</p> <p>41 42  (Note)</p> <p>51 52  (Note)</p> <p>63 64</p>	M20	HS1T-VJ44ZM-G	HS1T-VJ7Y4ZM-G
			M20	HS1T-VW44ZM-G	HS1T-VW7Y4ZM-G
VW	<p>Door Monitor: 1NO</p> <p>Monitor Circuit: 13 14</p> <p>Monitor Circuit:</p> <p>Monitor Circuit:</p>	<p>Lock Monitor Circuit: 3NC</p> <p>41 42  (Note)</p> <p>51 52  (Note)</p> <p>61 62  (Note)</p>	M20	HS1T-VW44ZM-G	HS1T-VW7Y4ZM-G
			M20	HS1T-VX44ZM-G	HS1T-VX7Y4ZM-G
VX	<p>Door Monitor: 1NO</p> <p>Monitor Circuit: 13 14</p> <p>Monitor Circuit:</p> <p>Monitor Circuit:</p>	<p>Lock Monitor Circuit: 2NC, 1NO</p> <p>41 42  (Note)</p> <p>51 52  (Note)</p> <p>63 64</p>	M20	HS1T-VX44ZM-G	HS1T-VX7Y4ZM-G

- The contact configuration shows the status when the actuator is inserted and the switch is locked.
- Actuators are not supplied with the interlock switch and must be ordered separately.
- For safety circuit input, connect to the monitor circuit with  marking.
- For side-conduit model, contact IDEC for details. (Part No: HS1T-□□□□SM-G)
- See page 9 to 12 for circuit diagrams and operating characteristics.

Note: Both spring lock and solenoid lock models have marking for lock monitoring. Note that solenoid lock models can be used in applications where lock for safety purpose is found unnecessary after a risk assessment, e.g. locking is needed for purposes such as in production processes.

2-Contact (Spring Lock/Solenoid Lock)

Circuit Code	Contact Configuration	Gland Port Size	Spring lock	Solenoid
			Part No.	
XD	<p>Door Monitor (Actuator inserted)</p> <p>Door Monitor: 1NC Monitor Circuit: ⊖ 11 12 Monitor Circuit: ⊖ 21 22</p> <p>Lock Monitor Circuit: 1NC 41 42 (Note)</p>	M20	HS1T-XD44ZM-G	HS1T-XD7Y4ZM-G
XF	<p>Door Monitor: 2NC Monitor Circuit: ⊖ 11 12 Monitor Circuit: ⊖ 21 22</p>	M20	/	
XG	<p>Door Monitor: 1NC, 1NO Monitor Circuit: ⊖ 11 12 Monitor Circuit: ⊖ 23 24</p>	M20		
XH	<p>Lock Monitor Circuit: 2NC 41 42 (Note) 51 52 (Note)</p>	M20	HS1T-XH44ZM-G	HS1T-XH7Y4ZM-G
			HS1T-XH44ZSM-G (side-conduit model)	
			HS1T-XH44ZLM-G (rear unlock button model)	HS1T-XH7Y4ZSM-G (side-conduit model)
			HS1T-XH44ZLSM-G (rear unlock button model, side-conduit model)	

- The contact configuration shows the status when the actuator is inserted and the switch is locked.
- Actuators are not supplied with the interlock switch and must be ordered separately.
- For safety circuit input, connect to the monitor circuit with marking.
- For side-conduit model, contact IDEC for details. (Part No: HS1T-□□□SM-G)
- See page 13 to 14 for circuit diagrams and operating characteristics.

Note: Both spring lock and solenoid lock models have marking for lock monitoring. Note that solenoid lock models can be used in applications where lock for safety purpose is found unnecessary after a risk assessment, e.g. locking is needed for purposes such as in production processes.

4-Contact/Rear Unlock Button (Spring Lock)

Package Quantity: 1

Circuit Code	Contact Configuration	Gland Port Size	Spring lock
			Part No.
VA	<p>Door Monitor (Actuator inserted)</p> <p>Lock Monitor (Solenoid OFF)</p> <p>Door Monitor: 1NC,1NO Monitor Circuit: ⊖ 11 ↗ 12 Monitor Circuit: ⊖ 23 ↘ 24 Monitor Circuit:</p> <p>Lock Monitor Circuit: 1NC,1NO 41 ↗ 42 (Note) 53 ↘ 54</p>	M20	HS1T-VA44ZLM-G
VB	<p>Door Monitor: 1NC,1NO Monitor Circuit: ⊖ 11 ↗ 12 Monitor Circuit: ⊖ 23 ↘ 24 Monitor Circuit:</p> <p>Lock Monitor Circuit: 2NC 41 ↗ 42 (Note) 51 ↗ 52 (Note)</p>	M20	HS1T-VB44ZLM-G
VC	<p>Door Monitor: 2NC Monitor Circuit: ⊖ 11 ↗ 12 Monitor Circuit: ⊖ 21 ↗ 22 Monitor Circuit:</p> <p>Lock Monitor Circuit: 1NC,1NO 41 ↗ 42 (Note) 53 ↘ 54</p>	M20	HS1T-VC44ZLM-G
VD	<p>Door Monitor: 2NC Monitor Circuit: ⊖ 11 ↗ 12 Monitor Circuit: ⊖ 21 ↗ 22 Monitor Circuit:</p> <p>Lock Monitor Circuit: 2NC 41 ↗ 42 (Note) 51 ↗ 52 (Note)</p>	M20	HS1T-VD44ZLM-G HS1T-VD44ZLSM-G (side-conduit model)
VF	<p>Door Monitor: 3NC Monitor Circuit: ⊖ 11 ↗ 12 Monitor Circuit: ⊖ 21 ↗ 22 Monitor Circuit: ⊖ 31 ↗ 32</p> <p>Lock Monitor Circuit: 1NC 41 ↗ 42 (Note)</p>	M20	HS1T-VF44ZLM-G HS1T-VF44ZLSM-G (side-conduit model)
VJ	<p>Door Monitor: 1NC Monitor Circuit: ⊖ 11 ↗ 12 Monitor Circuit: Monitor Circuit:</p> <p>Lock Monitor Circuit: 2NC,1NO 41 ↗ 42 (Note) 51 ↗ 52 (Note) 63 ↘ 64</p>	M20	HS1T-VJ44ZLM-G

• See page 8 to 9 for circuit diagrams and operating characteristics.

4-Contact/Dual Safety Circuit (Spring Lock)

Package Quantity: 1

Circuit Code	Contact Configuration	Gland Port Size	Spring lock
			Part No.
DD	<p>Main Circuit: 1NC+1NC, 1NC+1NC</p> <p>Door Monitor (Actuator inserted)</p> <p>Lock Monitor (Solenoid OFF)</p> <p>Monitor Circuit: ⊖ 11 ↗ 12 Monitor Circuit: ⊖ 21 ↗ 22</p> <p>41 ↗ 42 (Note) 51 ↗ 52 (Note)</p>	M20	HS1T-DD44ZM-G HS1T-DD44ZSM-G (side-conduit model)

• See page 12 for circuit diagrams and operating characteristics.

4-Contact/Dual Safety Circuit/Rear Unlock Button (Spring Lock)

Package Quantity: 1

Circuit Code	Contact Configuration	Gland Port Size	Spring lock
			Part No.
DD	<p>Main Circuit: 1NC+1NC, 1NC+1NC</p> <p>Door Monitor (Actuator inserted)</p> <p>Lock Monitor (Solenoid OFF)</p> <p>Monitor Circuit: ⊖ 11 ↗ 12 Monitor Circuit: ⊖ 21 ↗ 22</p> <p>41 ↗ 42 (Note) 51 ↗ 52 (Note)</p>	M20	HS1T-DD44ZLM-G HS1T-DD44ZLSM-G (side-conduit model)

• See page 12 for circuit diagrams and operating characteristics.

- The contact configuration shows the status when the actuator is inserted and the switch is locked.
- Actuators are not supplied with the interlock switch and must be ordered separately.

Circuit Diagrams and Operating Characteristics

4-Contact/Rear Unlock Button (Spring Lock)

Interlock Switch Status		Status 1	Status 2	Status 3	Status 4	When unlocking manually
		Door closed Machine ready to operate Solenoid de-energized	Door closed Machine cannot be operated Solenoid energized	Door open Machine cannot be operated Solenoid energized	Door open Machine cannot be operated Solenoid de-energized	Door closed Machine cannot be operated Solenoid de-energized
Door Status						
Circuit Example: HS1T-VA4						
Door		Closed (locked)	Closed (unlocked)	Open	Open	Closed (unlocked)
Part No. and Circuit Diagram	HS1T-VA4 Door Monitor (Actuator inserted) Lock Monitor (Solenoid OFF) Monitor Circuit: ⊕11, 12 41, 42 ⊞ Monitor Circuit: 23, 24 53, 54	Monitor Circuit (door closed) 11-12	Monitor Circuit (door open) 23-24	Monitor Circuit (locked) 41-42	Monitor Circuit (unlocked) 53-54	
	HS1T-VB4 Monitor Circuit: ⊕11, 12 41, 42 ⊞ Monitor Circuit: 23, 24 51, 52 ⊞	Monitor Circuit (door closed) 11-12	Monitor Circuit (door open) 23-24	Monitor Circuit (locked) 41-42	Monitor Circuit (locked) 51-52	
	HS1T-VC4 Monitor Circuit: ⊕11, 12 41, 42 ⊞ Monitor Circuit: ⊕21, 22 53, 54	Monitor Circuit (door closed) 11-12	Monitor Circuit (door closed) 21-22	Monitor Circuit (locked) 41-42	Monitor Circuit (unlocked) 53-54	
	HS1T-VD4 Monitor Circuit: ⊕11, 12 41, 42 ⊞ Monitor Circuit: ⊕21, 22 51, 52 ⊞	Monitor Circuit (door closed) 11-12	Monitor Circuit (door closed) 21-22	Monitor Circuit (locked) 41-42	Monitor Circuit (locked) 51-52	
	HS1T-VF4 Monitor Circuit: ⊕11, 12 41, 42 ⊞ Monitor Circuit: ⊕21, 22 31, 32 Monitor Circuit: ⊕31, 32 41, 42	Monitor Circuit (door closed) 11-12	Monitor Circuit (door closed) 21-22	Monitor Circuit (door closed) 31-32	Monitor Circuit (locked) 41-42	
	HS1T-VG4 Monitor Circuit: ⊕11, 12 41, 42 ⊞ Monitor Circuit: ⊕21, 22 33, 34 Monitor Circuit: 33, 34 41, 42	Monitor Circuit (door closed) 11-12	Monitor Circuit (door closed) 21-22	Monitor Circuit (door open) 33-34	Monitor Circuit (door locked) 41-42	
	HS1T-VH4 Monitor Circuit: ⊕11, 12 41, 42 ⊞ Monitor Circuit: 51, 52 ⊞ Monitor Circuit: 61, 62 ⊞	Monitor Circuit (door closed) 11-12	Monitor Circuit (locked) 41-42	Monitor Circuit (locked) 51-52	Monitor Circuit (locked) 61-62	
Solenoid Power A1-A2 (all models)		OFF (de-energized)	ON (energized)	ON (energized)	OFF (de-energized)	OFF (de-energized)

- The contact configuration shows the status when the actuator is inserted and the switch is locked.
- Monitor Circuit: Sends monitoring signals of protective door open/closed status (door monitor) or protective door lock/unlock status (lock monitor).

*1) Actuator can be unlocked manually for confirming the door movement before wiring and energizing, and also for emergency situation such as power failure.

*2) When an operator is confined within a dangerous zone, the actuator can be unlocked manually by pressing the rear unlock button (rear unlock button model).

Circuit Diagrams and Operating Characteristics

4-Contact/Rear Unlock Button (Spring Lock)

Interlock Switch Status	Status 1	Status 2	Status 3	Status 4	When unlocking manually		
	Door Closed Machine ready to operate Solenoid de-energized	Door Closed Machine cannot be operated Solenoid energized	Door open Machine cannot be operated Solenoid energized	Door open Machine cannot be operated Solenoid de-energized		Door Closed Machine cannot be operated Solenoid de-energized	
Door Status					 • Turn the manual unlock key (*1) • Press the rear unlocking button (*2)		
Circuit Example: HS1T-VA4							
Door	Closed (locked)	Closed (unlocked)	Open	Open	Closed (unlocked)		
Part No. and Circuit Diagram	HS1T-VJ4 Door Monitor (Actuator inserted) Lock Monitor (Solenoid OFF) (+) A2 (-) A1 Monitor Circuit: 11-12, 41-42 Monitor Circuit: 51-52 Monitor Circuit: 63-64	Monitor Circuit (door closed) 11-12					
		Monitor Circuit (locked) 41-42					
		Monitor Circuit (locked) 51-52					
		Monitor Circuit (unlocked) 63-64					
	HS1T-VW4 Monitor Circuit: 13-14, 41-42 Monitor Circuit: 51-52 Monitor Circuit: 61-62	Monitor Circuit (door open) 13-14					
		Monitor Circuit (locked) 41-42					
		Monitor Circuit (locked) 51-52					
		Monitor Circuit (locked) 61-62					
	HS1T-VX4 Monitor Circuit: 13-14, 41-42 Monitor Circuit: 51-52 Monitor Circuit: 63-64	Monitor Circuit (door open) 13-14					
		Monitor Circuit (locked) 41-42					
		Monitor Circuit (locked) 51-52					
		Monitor Circuit (unlocked) 63-64					
Solenoid Power A1-A2 (all models)	OFF (de-energized)	ON (energized)	ON (energized)	OFF (de-energized)	OFF (de-energized)		

- The contact configuration shows the status when the actuator is inserted and the switch is locked.
- Monitor Circuit: Sends monitoring signals of protective door open/closed status (door monitor) or protective door lock/unlock status (lock monitor).

*1) Actuator can be unlocked manually for confirming the door movement before wiring and energizing, and also for emergency situation such as power failure.
 *2) When an operator is confined within a dangerous zone, the actuator can be unlocked manually by pressing the rear unlock button (rear unlock button model).

Operating Characteristics (Reference)

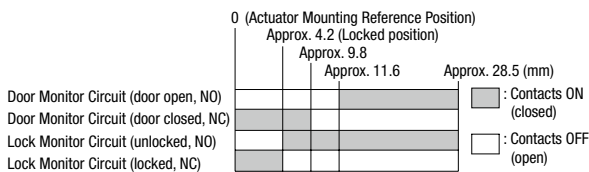

- The characteristics shown in the chart above are of the straight actuator (HS9Z-A11T) and right-angle actuator (HS9Z-A12T).
- The operation characteristics show the contact status when the actuator enters the entry slot of an interlock switch.

Circuit Diagrams and Operating Characteristics

4-Contact (Solenoid Lock)

Interlock Switch Status		Status 1	Status 2	Status 3	Status 4	Unlocking using Manual Unlock Key
		Door closed Machine ready to operate Solenoid energized	Door closed Machine cannot be operated Solenoid de-energized	Door open Machine cannot be operated Solenoid de-energized	Door open Machine cannot be operated Solenoid energized	Door closed Machine cannot be operated Solenoid de-energized → energized
Door Status						
Circuit Example: HS1T-VA7Y						
Door		Closed (locked)	Closed (unlocked)	Open	Open	Closed (unlocked)
Part No. and Circuit Diagram	HS1T-VA7Y Door Monitor (Actuator inserted) Lock Monitor (Solenoid ON) Monitor Circuit: 11-12, 23-24, 53-54	Monitor Circuit (door closed) 11-12				
		Monitor Circuit (door open) 23-24				
		Monitor Circuit (locked) 41-42				
		Monitor Circuit (unlocked) 53-54				
	HS1T-VB7Y Monitor Circuit: 11-12, 23-24, 51-52	Monitor Circuit (door closed) 11-12				
		Monitor Circuit (door open) 23-24				
		Monitor Circuit (locked) 41-42				
		Monitor Circuit (locked) 51-52				
	HS1T-VC7Y Monitor Circuit: 11-12, 21-22, 53-54	Monitor Circuit (door closed) 11-12				
		Monitor Circuit (door closed) 21-22				
		Monitor Circuit (locked) 41-42				
		Monitor Circuit (unlocked) 53-54				
	HS1T-VD7Y Monitor Circuit: 11-12, 21-22, 51-52	Monitor Circuit (door closed) 11-12				
		Monitor Circuit (door closed) 21-22				
		Monitor Circuit (locked) 41-42				
		Monitor Circuit (locked) 51-52				
Solenoid Power A1-A2 (all models)		ON (energized)	OFF (de-energized)	OFF (de-energized)	ON (energized) (*2)	OFF (de-energized) → ON (energized) (*1) (*2)

- The contact configuration shows the status when the actuator is inserted and the switch is locked.
- Monitor Circuit: Sends monitoring signals of protective door open/closed status (door monitor) or protective door lock/unlock status (lock monitor).

*1) Do not attempt manual unlocking when the solenoid is energized.
 *2) Do not energize the solenoid for a long time while the door is open or when the door is unlocked manually.
 *3) Both spring lock and solenoid lock models have marking for lock monitoring. Note that solenoid lock models can be used in applications where lock for safety purpose is found unnecessary after a risk assessment, e.g. locking is needed for purposes such as in production processes.

Operating Characteristics (Reference)

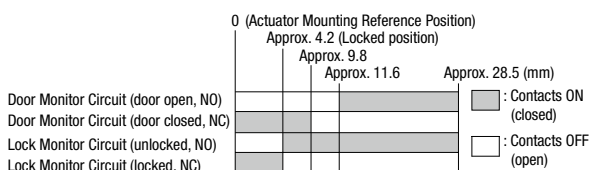

- The characteristics shown in the chart above are of the straight actuator (HS9Z-A11T) and right-angle actuator (HS9Z-A12T).
- The operation characteristics show the contact status when the actuator enters the entry slot of an interlock switch.

Circuit Diagrams and Operating Characteristics

4-Contact (Solenoid Lock)

Interlock Switch Status		Status 1	Status 2	Status 3	Status 4	Unlocking using Manual Unlock Key	
		Door closed Machine ready to operate Solenoid energized	Door closed Machine cannot be operated Solenoid de-energized	Door open Machine cannot be operated Solenoid de-energized	Door open Machine cannot be operated Solenoid energized	Door closed Machine cannot be operated Solenoid de-energized → energized	
Door Status							
Circuit Example: HS1T-VA7Y							
Door		Closed (locked)	Closed (unlocked)	Open	Open	Closed (unlocked)	
Part No. and Circuit Diagram	HS1T-VF7Y Door Monitor (Actuator inserted) Lock Monitor (Solenoid ON) Monitor Circuit: ⊖11, 12 41, 42 (NC)*3 Monitor Circuit: ⊖21, 22 Monitor Circuit: ⊖31, 32		Monitor Circuit (door closed) 11-12				
			Monitor Circuit (door closed) 21-22				
			Monitor Circuit (door closed) 31-32				
			Monitor Circuit (locked) 41-42				
	HS1T-VH7Y Monitor Circuit: ⊖11, 12 41, 42 (NC)*3 Monitor Circuit: 51, 52 (NC)*3 Monitor Circuit: 61, 62 (NC)*3		Monitor Circuit (door closed) 11-12				
			Monitor Circuit (locked) 41-42				
			Monitor Circuit (locked) 51-52				
			Monitor Circuit (locked) 61-62				
	HS1T-VG7Y Monitor Circuit: ⊖11, 12 41, 42 (NC)*3 Monitor Circuit: ⊖21, 22 Monitor Circuit: 33, 34		Monitor Circuit (door closed) 11-12				
			Monitor Circuit (door closed) 21-22				
			Monitor Circuit (door open) 33-34				
			Monitor Circuit (locked) 41-42				
	HS1T-VJ7Y Monitor Circuit: ⊖11, 12 41, 42 (NC)*3 Monitor Circuit: 51, 52 (NC)*3 Monitor Circuit: 63, 64		Monitor Circuit (door closed) 11-12				
			Monitor Circuit (locked) 41-42				
			Monitor Circuit (locked) 51-52				
			Monitor Circuit (unlocked) 63-64				
	HS1T-VW7Y Monitor Circuit: ⊖13, 14 41, 42 (NC)*3 Monitor Circuit: 51, 52 (NC)*3 Monitor Circuit: 61, 62 (NC)*3		Monitor Circuit (door open) 13-14				
			Monitor Circuit (locked) 41-42				
			Monitor Circuit (locked) 51-52				
			Monitor Circuit (locked) 61-62				
	HS1T-VX7Y Monitor Circuit: ⊖13, 14 41, 42 (NC)*3 Monitor Circuit: 51, 52 (NC)*3 Monitor Circuit: 63, 64		Monitor Circuit (door open) 13-14				
			Monitor Circuit (locked) 41-42				
			Monitor Circuit (locked) 51-52				
			Monitor Circuit (unlocked) 63-64				
Solenoid Power A1-A2 (all models)		ON (energized)	OFF (de-energized)	OFF (de-energized)	ON (energized) (*2)	OFF (de-energized) → ON (energized) (*1) (*2)	

- The contact configuration shows the status when the actuator is inserted and the switch is locked.
- Monitor Circuit: Sends monitoring signals of protective door open/closed status (door monitor) or protective door lock/unlock status (lock monitor).

*1) Do not attempt manual unlocking when the solenoid is energized.
 *2) Do not energize the solenoid for a long time while the door is open or when the door is unlocked manually.
 *3) Both spring lock and solenoid lock models have marking for lock monitoring. Note that solenoid lock models can be used in applications where lock for safety purpose is found unnecessary after a risk assessment, e.g. locking is needed for purposes such as in production processes.

Operating Characteristics (Reference)

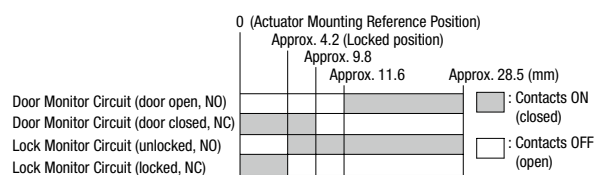

- The characteristics shown in the chart above are of the straight actuator (HS9Z-A11T) and right-angle actuator (HS9Z-A12T).
- The operation characteristics show the contact status when the actuator enters the entry slot of an interlock switch.

Circuit Diagrams and Operating Characteristics

4-Contact/Dual Safety Circuit, 4-Contact/Dual Safety Circuit/Rear Unlock Button (Spring Lock)

Interlock Switch Status		Status 1	Status 2	Status 3	Status 4	Unlocking using Manual Unlock Key
		Door closed Machine ready to operate Solenoid de-energized	Door closed Machine cannot be operated Solenoid energized	Door open Machine cannot be operated Solenoid energized	Door open Machine cannot be operated Solenoid de-energized	
Door Status						 • Turn the manual unlock key (*1) • Press the rear unlocking button (*2)
Circuit Example: HS1T-DD4						
Door		Closed (locked)	Closed (unlocked)	Open	Open	Closed (unlocked)
Part No. and Circuit Diagram	HS1T-DD44 Door Monitor (Actuator inserted) Lock Monitor (Solenoid OFF) Monitor Circuit: 11-12 41-42 Monitor Circuit: 21-22 51-52	Main Circuit 11-42				
	HS1T-DD44L Monitor Circuit: 11-12 41-42 Monitor Circuit: 21-22 51-52	Main Circuit 11-42				
Solenoid Power A1-A2 (all model)		OFF (de-energized)	ON (energized)	ON (energized)	OFF (de-energized)	OFF (de-energized)

- The contact configuration shows the status when the actuator is inserted and the switch is locked.
- Main Circuit: Connected to the control circuit of machine drive part, sending interlock signals of the protective door.
- For safety circuit input, connect to the monitor circuit.

*1) Actuator can be unlocked manually for confirming the door movement before wiring and energizing, and also for emergency situation such as power failure.
 *2) When an operator is confined within a dangerous zone, the actuator can be unlocked manually by pressing the rear unlock button. (rear unlock button model)

Operating Characteristics (Reference)

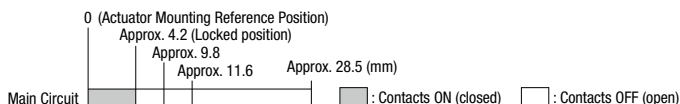

- The characteristics shown in the chart above are of the straight actuator (HS9Z-A11T) and right-angle actuator (HS9Z-A12T).
- The operation characteristics show the contact status when the actuator enters the entry slot of an interlock switch.

Circuit Diagrams and Operating Characteristics

2-Contact (Spring Lock)

Interlock Switch Status		Status 1	Status 2	Status 3	Status 4	When unlocking manually
		Door closed Machine ready to operate Solenoid de-energized	Door closed Machine cannot be operated Solenoid energized	Door open Machine cannot be operated Solenoid energized	Door open Machine cannot be operated Solenoid de-energized	Door closed Machine cannot be operated Solenoid de-energized
Door Status						<ul style="list-style-type: none"> • Turn the manual unlock key (*1) • Press the rear unlocking button (*2)
Circuit Example: HS1T-XD4						
Door		Closed (locked)	Closed (unlocked)	Open	Open	Closed (unlocked)
Part No. and Circuit Diagram	HS1T-XD4 Door Monitor (Actuator inserted) Lock Monitor (Solenoid OFF) Monitor Circuit: 11-12 Monitor Circuit: 41-42	Monitor Circuit (door closed) 11-12				
	HS1T-XH4 Monitor Circuit: 41-42 Monitor Circuit: 51-52	Monitor Circuit (locked) 41-42				
		Monitor Circuit (locked) 41-42				
		Monitor Circuit (locked) 51-52				
Solenoid Power A1-A2 (all model)		OFF (de-energized)	ON (energized)	ON (energized)	OFF (de-energized)	OFF (de-energized)

- The contact configuration shows the status when the actuator is inserted and the switch is locked.
- Monitor Circuit: Sends monitoring signals of protective door open/closed status (door monitor) or protective door lock/unlock status (lock monitor).

*1) Actuator can be unlocked manually for confirming the door movement before wiring and energizing, and also for emergency situation such as power failure.
 *2) When an operator is confined within a dangerous zone, the actuator can be unlocked manually by pressing the rear unlock button. (rear unlock button model)

Operating Characteristics (Reference)

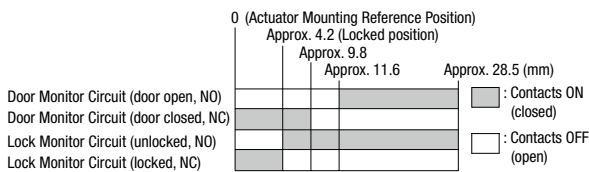

- The characteristics shown in the chart above are of the straight actuator (HS9Z-A11T) and right-angle actuator (HS9Z-A12T).
- The operation characteristics show the contact status when the actuator enters the entry slot of an interlock switch.

Circuit Diagrams and Operating Characteristics

2-Contact (Solenoid Lock)

Interlock Switch Status	Status 1	Status 2	Status 3	Status 4	Unlocking using Manual Unlock Key
	Door closed Machine ready to operate Solenoid energized	Door closed Machine cannot be operated Solenoid de-energized	Door open Machine cannot be operated Solenoid de-energized	Door open Machine cannot be operated Solenoid energized	
Door Status					 When unlocking manually
Circuit Example: HS1T-XD7Y					
Door	Closed (locked)	Closed (unlocked)	Open	Open	Closed (unlocked)
Part No. and Circuit Diagram	HS1T-XD7Y Door Monitor (Actuator inserted) Lock Monitor (Solenoid ON) Monitor Circuit: ⊕ 11, 12 Monitor Circuit: 41, 42 (⊖) (*4)	Monitor Circuit (door closed) 11-12 Monitor Circuit (locked) 41-42			
	HS1T-XF7Y (*3) Monitor Circuit: ⊕ 11, 12 Monitor Circuit: ⊕ 21, 22	Monitor Circuit (door closed) 11-12 Monitor Circuit (door closed) 21-22			
	HS1T-XG7Y (*3) Monitor Circuit: ⊕ 11, 12 Monitor Circuit: 23, 24	Monitor Circuit (door closed) 11-12 Monitor Circuit (door open) 23-24			
	HS1T-XH7Y Monitor Circuit: 41, 42 (⊖) (*4) Monitor Circuit: 51, 52 (⊖) (*4)	Monitor Circuit (locked) 41-42 Monitor Circuit (locked) 51-52			
Solenoid Power A1-A2 (all models)	OFF (energized)	OFF (de-energized)	OFF (de-energized)	ON (energized) (*2)	OFF (de-energized) → ON (energized) (*1) (*2)

- The contact configuration shows the status when the actuator is inserted and the switch is locked.
- Monitor Circuit: Sends monitoring signals of protective door open/closed status (door monitor) or protective door lock/unlock status (lock monitor).

*1) Do not unlock manually while the solenoid is energized.
 *2) Do not energize the solenoid for a long period of time while the door is open or while the door is unlocked manually.
 *3) Circuit codes XF and XG do not have signals to notify whether the switch is locked or unlocked. A different method should be used to check the lock status.
 *4) Both spring lock and solenoid lock models have marking for lock monitoring. Note that solenoid lock models can be used in applications where lock for safety purpose is found unnecessary after a risk assessment, e.g. locking is needed for purposes such as in production processes.

Operating Characteristics (Reference)

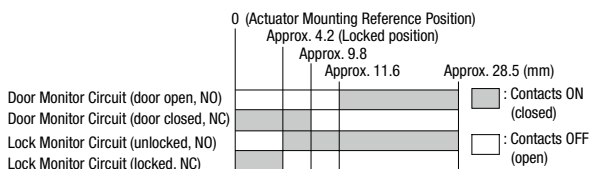

- The characteristics shown in the chart above are of the straight actuator (HS9Z-A11T) and right-angle actuator (HS9Z-A12T).
- The operation characteristics show the contact status when the actuator enters the entry slot of an interlock switch.

Interlock Switch Dimensions and Mounting Hole Layouts

All dimensions in mm

HS1T-□□4ZM-G

When using Horizontal Mounting/Straight Actuator (HS9Z-A11T)

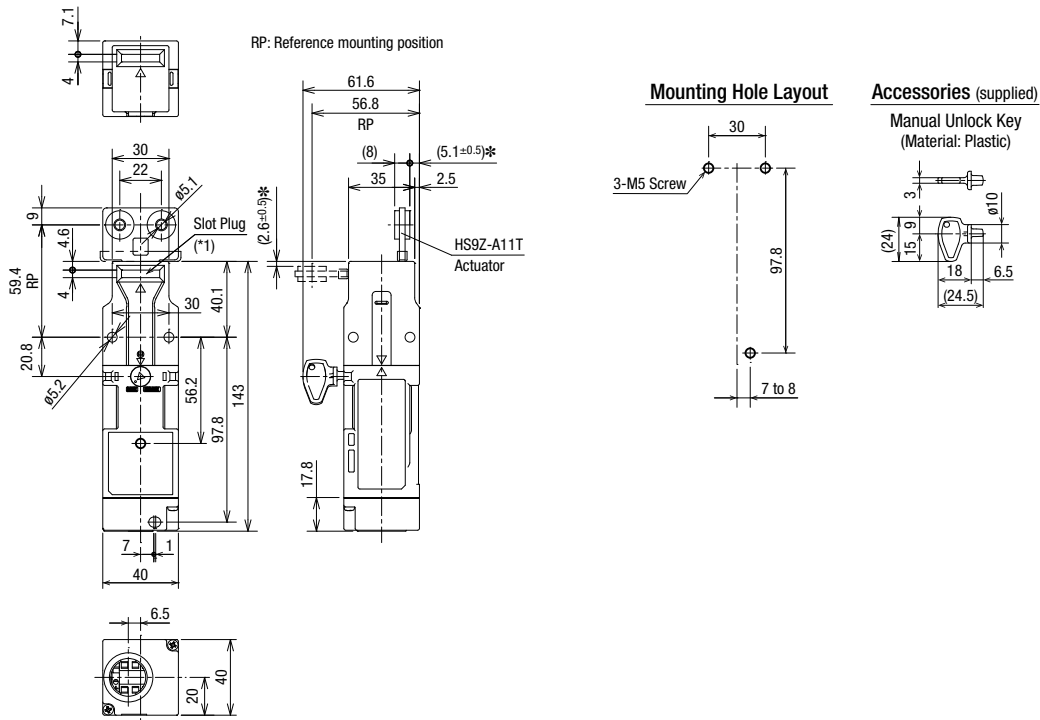

HS1T-□□4ZSM-G (side-conduit model)

When using Horizontal Mounting/Straight Actuator (HS9Z-A11T)

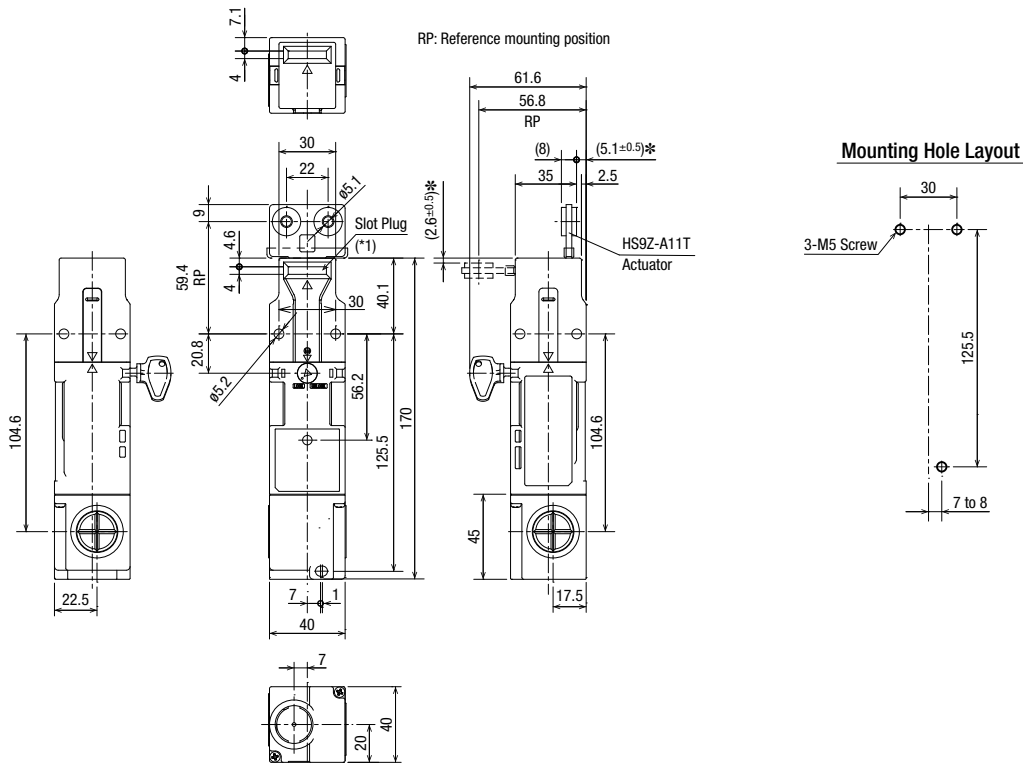

• Dimensions above are at factory setting.

*1) Be sure to plug unused actuator entry slots using square plugs so that dust does not enter into the entry slots. (Square plug is inserted at factory setting.)

* Actuator mounting reference position

Interlock Switch Dimensions and Mounting Hole Layouts All dimensions in mm

HS1T-□□4ZLM-G (with rear unlock button)
 When using Horizontal Mounting/Straight Actuator (HS9Z-A11T)

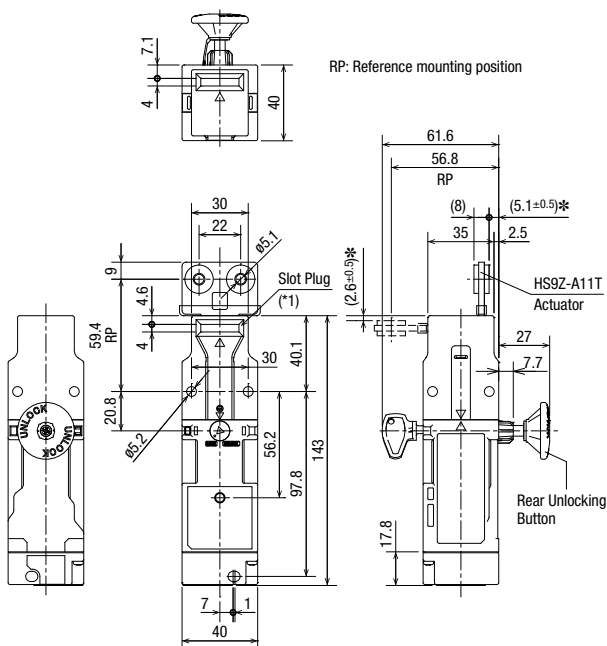

Mounting Hole Layout

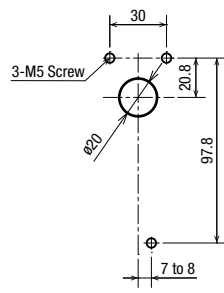

Accessories (supplied)

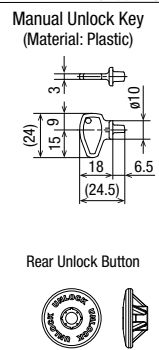

HS1T-□□4ZLSM-G (side-conduit model/rear unlock button)
 When using Horizontal Mounting/Straight Actuator (HS9Z-A11T)

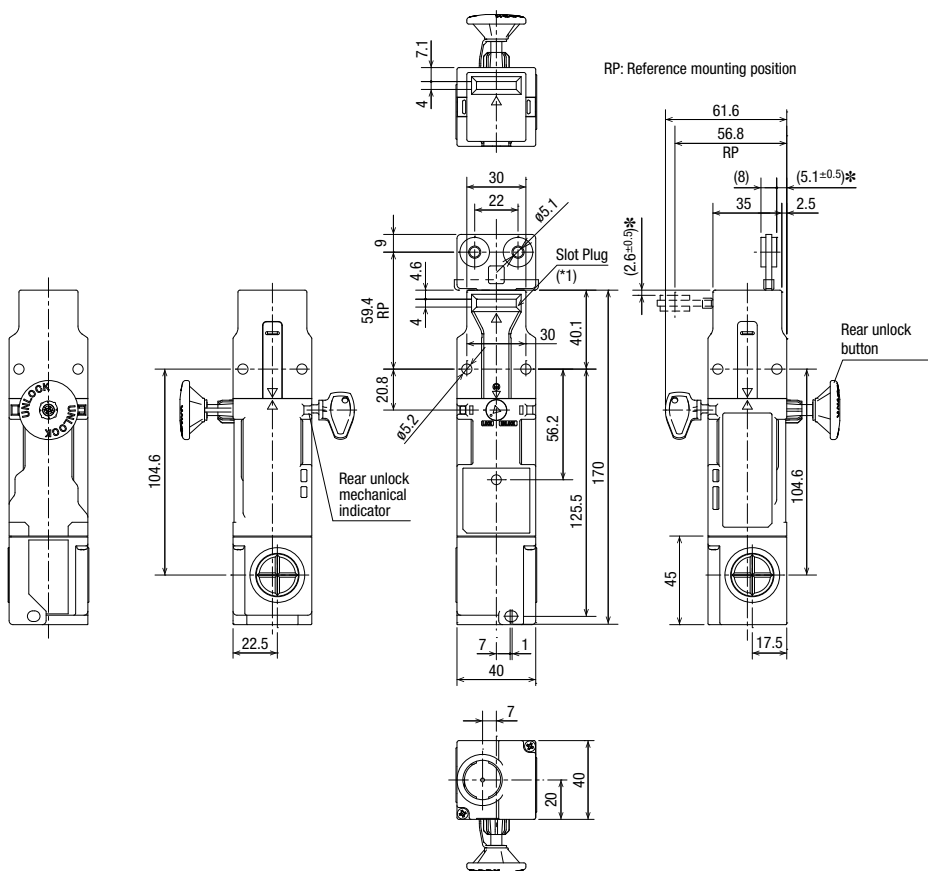

Mounting Hole Layout

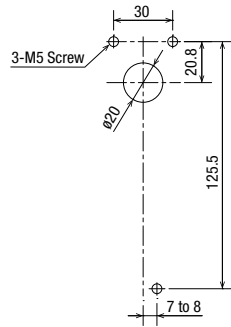

- Dimensions above are at factory setting.
- *1) Be sure to plug unused actuator entry slots using square plugs so that dust does not enter into the entry slots. (Square plug is inserted at factory setting.)
- * Actuator mounting reference position

Actuator / Accessory

Actuator

Description	Part No. (Ordering Part No.)	Package Quantity	Remarks
Straight with rubber bushings	HS9Z-A11T	1	Actuator retention force is Fzh=5,000N.
Right-angle with rubber bushings	HS9Z-A12T	1	

• Above actuators can only be used for HS1T. Do not used on other models.

Note) Use dedicated actuators only. When other actuators are used, the interlock switch may be damaged.

Accessory

Description	Part No. (Ordering Part No.)	Package Quantity	Remarks
Manual Unlock Key (long)	HS9Z-T3	1	Material: Metal (Used if the HS1T is installed far inside the equipment to reach to the manual lock.)

Interlock Switch Dimensions and Mounting Hole Layouts

All dimensions in mm

Actuator

Straight with rubber bushings
HS9Z-A11T

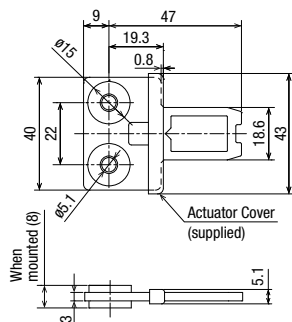

Right-angle with rubber bushings
HS9Z-A12T

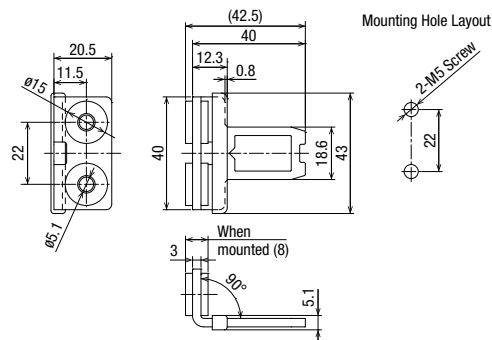

Accessory

Manual Unlock Key (long) (metal)
HS9Z-T3

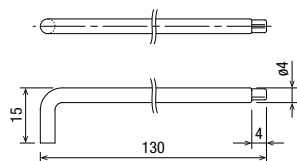

 Safety Precautions

- Turn power off before installation, removal, wiring, maintenance, or inspection of the interlock switch. Otherwise electric shock or fire may occur.
- If relays are used in the circuit between the interlock switch and the load, use only safety relays, since welded or sticking contacts of standard relays may invalidate the functions of the interlock switch. Perform a risk assessment and make a safety circuit which satisfies the requirements of the safety category.
- Do not place a PLC in the circuit between the interlock switch and the load. Safety security can be endangered in the event of a malfunction of the PLC.
- Do not disassemble or modify the interlock switch, otherwise malfunction or accident may occur.
- Do not install the actuator in a location where a human body may come into contact. Otherwise injury may occur.
- Solenoid lock is locked when energized, and unlocked when de-energized. When energization is interrupted due to wire disconnection or other failures, the interlock switch may be unlocked causing possible danger to the operators. Solenoid lock must not be used in applications where locking is strictly required for safety. Perform a risk assessment and determine whether solenoid lock is required.
- HS11T interlock switches are Type 2 low level coded interlocking devices (ISO14119). According to EN ISO/ ISO14119, the following is required to minimize defeat when installing and constructing systems:

1. Prevent dismantling or de-positioning of the elements of the interlocking device by use of non-detachable fixing (e.g. welding, gluing, one-way screws, riveting). However, use of non-detachable fixing can be an inappropriate solution in cases where a failure of the interlocking device during lifetime of the machinery can be expected and a fast change is necessary. In this case, measures mentioned below should be used to provide the required level of risk reduction.
2. Apply at least one out of the four measures below.
 - ① Mounting out of reach.
 - ② Physical obstruction or shielding.
 - ③ Mounting in hidden position.
 - ④ Integration of defeat monitoring by means of status monitoring/cyclic testing.

Instructions

Installation

- Do not apply excessive shock to the interlock switch when opening or closing the door. A shock to the interlock switch exceeding 1,000 m/s² may cause damage to the interlock switch.
- Install a guide on the door and make sure that force is not applied in the direction other than the actuator entry direction.
- Do not pull the actuator during lock status. Do not use the interlock switch as a locking device regardless of the door type. To install a locking device, use a bracket as mentioned in page 3 of the instruction manual.
- Make sure that the installation surface of the interlock switch is flat and has sufficient strength to not deform when the interlock switch is installed. Also, do not place foreign objects between the interlock switch and the installation surface. The interlock switch may not operate properly if the surface is not flat or a foreign object is placed in between.
- If the operating atmosphere is contaminated, use a protective cover to prevent entry of foreign objects into the interlock switch through the actuator entry slots. Entry of foreign objects into the interlock switch may affect the mechanism of the interlock switch and cause a breakdown.
- Make sure that the actuator does not scrape the entry of the metal head. Otherwise, damage may occur.
- Install the interlock switch in a location where there is no risk of damage. Also, perform risk assessment before use and take measures such as attaching a protective cover if necessary.
- While the solenoid is energized, the interlock switch temperature rises approximately 40°C above the ambient temperature (to approximately 95°C while the ambient temperature is 55°C). To prevent burns, do not touch. If cables come into contact with the interlock switch, use heat-resistant cables.
- The solenoid has polarity. Make sure of the correct polarity when wiring. Do not apply overvoltage, otherwise the solenoid will be burnt.
- When wiring, make sure that water or oil does not enter from the end of the cable.
- Use dedicated actuators only. If other actuators are used, the interlock switch may be damaged.
- When wiring to the terminal block using a screwdriver while holding the interlock switch in the hands, be careful not to damage fingers with the tip of the screwdriver.
- Do not push in the screwdriver with excessive force when wiring to the terminal block. Internal parts may crack and cause damage.
- Regardless of door types, do not use the interlock switch as a door stop. Install a mechanical door stop at the end of the door to protect the interlock switch against excessive force.
- Safety function of the door interlock switch will be lost if a spare key is inserted into the interlock switch. Make sure that a spare key is not used on the interlock switch.
- Do not cut or modify the actuator. Otherwise, damage may occur.
- If multiple safety components are wired in series, the Performance Level to EN ISO 13849-1 will be reduced due to degradation of the failure detection function.
- Insulation of the cable should withstand environmental influences.
- The entire concept of the control system, in which the safety component is integrated, must be validated to EN ISO 13849-2.

Instructions

Rotating the Head

- The rotating head has an allowable movement range. Do not turn the head exceed the movement range. Otherwise, damage may occur.
- Tightening the head stopper screw without aligning the \triangle marks indicated on the head and body may cause damage
- After installing the rear unlocking button, apply thread-locking adhesive to the screw so that the screw does not loosen.
- Make sure that foreign objects do not enter between the head and body when rotating the head.
- Make sure to tighten the head stopper screw securely. Loose screws may cause malfunction.
- Do not loosen the head stopper screw other than when rotating the head.

Manual Unlocking

- When locking or unlocking the interlock switch manually, turn the key fully using the manual unlock key supplied with the interlock switch as shown below. Using the interlock switch with the key not fully turned (less than 90°) may cause damage to the interlock switch or operation failures.
- When manually unlocked, the interlock switch will keep the main circuit disconnected and the door unlocked. Main circuit and lock monitor circuit remain open.

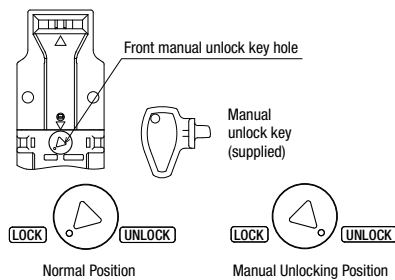

HS1T-□4

The HS1T-□4 allows manual unlocking of the actuator to pre-check proper door operation before wiring or turning power on, as well as for emergency use such as a power failure.

HS1T-□7Y

The solenoid interlock switch does not unlock even when the solenoid is de-energized. However, the interlock switch can be unlocked manually in emergency cases.

Notes

- Before manually unlocking the interlock switch, make sure that the machine has come to a complete stop. Manual unlocking during operation may unlock the interlock switch before the machine stops, and the function of interlock switch with solenoid is lost.
- On solenoid lock models, do not manually unlock while the solenoid is energized.
- Do not apply excessive force (0.45 N·m or more) to the manual unlock key hole, otherwise the hole will be damaged.
- Do not leave the manual unlock key attached to the interlock switch during operation. This is dangerous because the interlock switch can be unlocked while the machine is in operation.

Rear Unlock Button and Mechanical Indicator

HS1T-□L

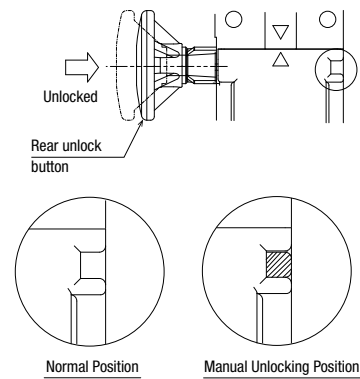

- Use the rear unlock button when a worker is locked inside a safety fence (hazard area). (Compliant with escape release described in EN ISO/ ISO 14119 [2003] and GS-ET-19)
- When the rear unlock button is pressed, the interlock switch is unlocked and the door can be opened.
- To lock the interlock switch, pull back the button. When the button remains pressed, the interlock switch cannot be locked even if the door is closed, and the main circuit remains open.
- When the rear unlock button is pressed, the mechanical indicator is displayed on the side of the interlock switch. The lock status can be identified from outside the safety fence.
- Install the rear unlock mechanical indicator on either side of the interlock switch.

Notes

- Install the rear unlock button inside the safety fence (hazardous area) where only the operator is accessible. Do not install where the rear unlock button can be reached by an operator outside the safety fence (hazardous area). Otherwise, the interlock switch may be unlocked during machine operation, causing danger.
- Operate the rear unlock button by hand only. Do not use a tool or with excessive force. Do not apply force to the button from the direction other than the proper direction, otherwise the button will be damaged.

IDEC CORPORATION

 www.idec.com

Head Office

6-64, Nishi-Miyahara-2-Chome, Yodogawa-ku, Osaka 532-0004, Japan

USA	IDEC Corporation	Tel: +1-408-747-0550	opencontact@idec.com	Hong Kong	IDEC Izumi (H.K.) Co., Ltd.	Tel: +852-2803-8989	info@hk.idec.com
Germany	APEM GmbH	Tel: +49-40-25 30 54 - 0	service@eu.idec.com	China/Shanghai	IDEC (Shanghai) Corporation	Tel: +86-21-6135-1515	idec@cn.idec.com
Singapore	IDEC Izumi Asia Pte. Ltd.	Tel: +65-6746-1155	info@sg.idec.com	China/Shenzhen	IDEC (Shenzhen) Corporation	Tel: +86-755-8356-2977	idec@cn.idec.com
Thailand	IDEC Asia (Thailand) Co., Ltd	Tel: +66-2-392-9765	sales@th.idec.com	China/Beijing	IDEC (Beijing) Corporation	Tel: +86-10-6581-6131	idec@cn.idec.com
Australia	IDEC Australia Pty. Ltd.	Tel: +61-3-8523-5900	sales@au.idec.com	Japan	IDEC Corporation	Tel: +81-6-6398-2527	marketing@idec.co.jp
Taiwan	IDEC Taiwan Corporation	Tel: +886-2-2698-3929	service@tw.idec.com				

Specifications and other descriptions in this catalog are subject to change without notice.
Information in this catalog is current as of May 2019.
2019 IDEC Corporation, All Rights Reserved.

EP1702-1

