

25 V, 2 A low drop power Schottky rectifier

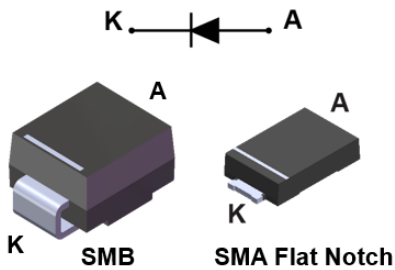

Features

- Very low forward voltage drop for less power dissipation
- Optimized conduction/reverse losses trade-off which means the highest efficiency in the applications
- Avalanche rated
- **ECOPACK2** compliant

Applications

- Cordless appliance
- SSD
- Battery charger
- Telecom power
- DC / DC converter

Description

Schottky rectifiers designed for high frequency miniature switched mode power supplies such as adaptors and on board DC/DC converters.

Packaged in SMA Flat Notch or SMB for thermal resistance characteristic improvement, the **STPS2L25** is ideal for use in parallel with MOSFETs in synchronous rectification.

Product status	
STPS2L25	
Product summary	
Symbol	Value
$I_{F(AV)}$	2 A
V_{RRM}	25 V
$T_{j(max.)}$	150 °C
$V_{F(typ.)}$	0.325 V

1 Characteristics

Table 1. Absolute ratings (limiting values at 25 °C, unless otherwise specified)

Symbol	Parameter		Value	Unit	
V_{RRM}	Repetitive peak reverse voltage		25	V	
$I_{F(RMS)}$	Forward rms current		10	A	
$I_{F(AV)}$	Average forward current, $\delta = 0.5$ square wave	SMB	$T_L = 125\text{ °C}$	2	A
		SMA Flat Notch	$T_L = 130\text{ °C}$		
I_{FSM}	Surge non repetitive forward current	SMB	$t_p = 10\text{ ms sinusoidal}$	75	A
		SMA Flat Notch		90	
P_{ARM}	Repetitive peak avalanche power		$t_p = 10\text{ }\mu\text{s}, T_j = 125\text{ °C}$	108	W
T_{stg}	Storage temperature range		-65 to +150	°C	
T_j	Maximum operating junction temperature ⁽¹⁾		+150	°C	

1. $(dP_{tot}/dT_j) < (1/R_{th(j-a)})$ condition to avoid thermal runaway for a diode on its own heatsink.

Table 2. Thermal resistance parameter

Symbol	Parameter		Max. value	Unit
$R_{th(j-l)}$	Junction to lead	SMB	25	°C/W
		SMA Flat Notch	20	

For more information, please refer to the following application note :

- AN5088 : Rectifiers thermal management, handling and mounting recommendations

Table 3. Static electrical characteristics

Symbol	Parameter	Test conditions	Min.	Typ.	Max.	Unit
$I_R^{(1)}$	Reverse leakage current	$T_j = 25\text{ °C}$	$V_R = V_{RRM}$	-	90	μA
		$T_j = 125\text{ °C}$		-	15	30
$V_F^{(1)}$	Forward voltage drop	$T_j = 25\text{ °C}$	$I_F = 2\text{ A}$	-	0.450	V
		$T_j = 125\text{ °C}$		-	0.325	
		$T_j = 25\text{ °C}$	$I_F = 4\text{ A}$	-	0.530	
		$T_j = 125\text{ °C}$		-	0.430	

1. Pulse test: $t_p = 380\text{ }\mu\text{s}, \delta < 2\%$

To evaluate the conduction losses, use the following equation:

$$P = 0.24 \times I_{F(AV)} + 0.068 \times I_{F(RMS)}^2$$

For more information, please refer to the following application notes related to the power losses :

- AN604: Calculation of conduction losses in a power rectifier
- AN4021: Calculation of reverse losses on a power diode

1.1 Characteristics (curves)

Figure 1. Average forward power dissipation versus average forward current

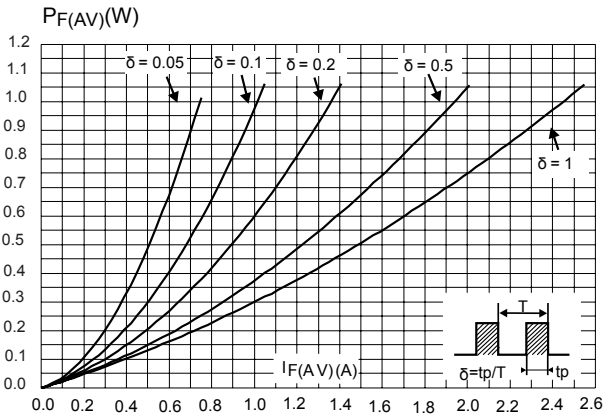

Figure 2. Average forward current versus ambient temperature ($\delta = 0.5$)

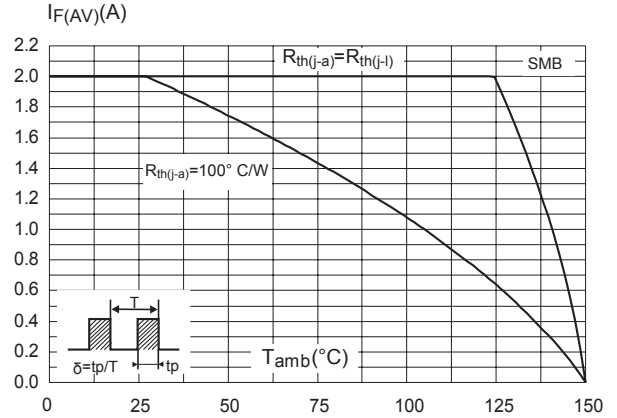

Figure 3. Normalized avalanche power derating versus junction temperature ($T_j = 125^{\circ}C$)

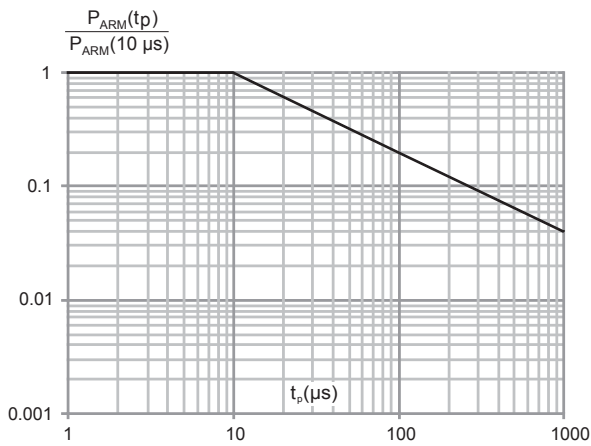

Figure 4. Relative variation of thermal impedance junction to ambient versus pulse duration

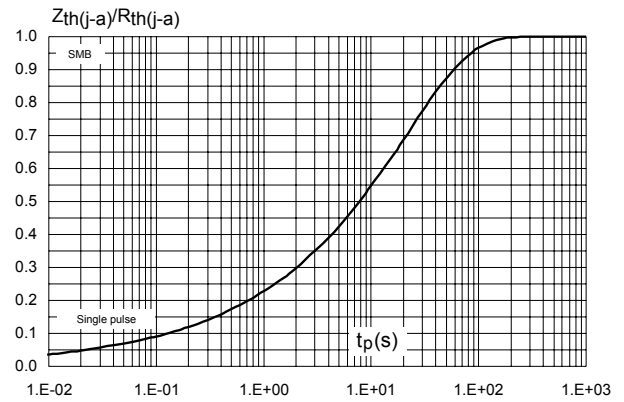

Figure 5. Reverse leakage current versus reverse voltage applied (typical values)

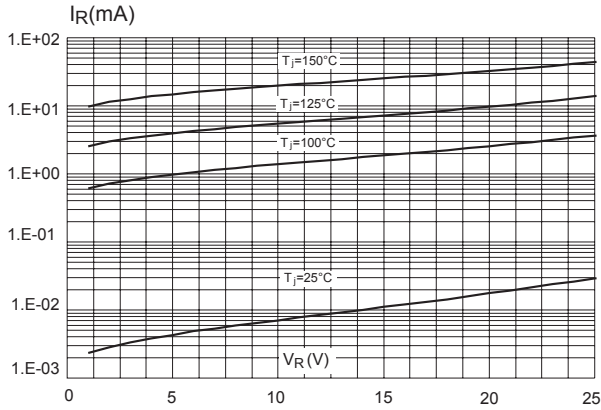

Figure 6. Junction capacitance versus reverse voltage applied (typical values)

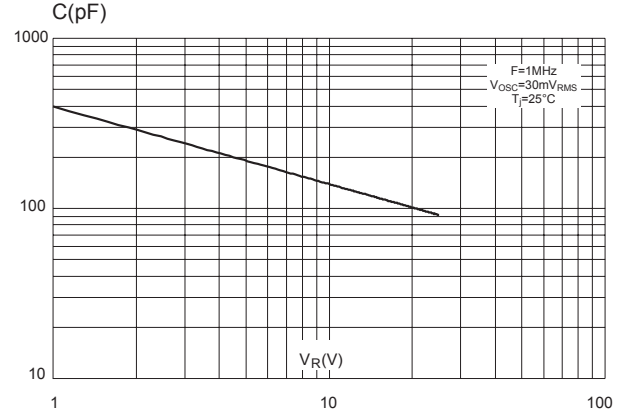

Figure 7. Forward voltage drop versus forward current (high level)

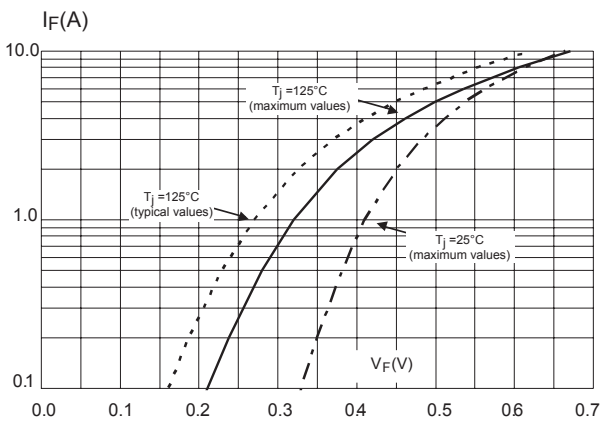

Figure 8. Forward voltage drop versus forward current (low level)

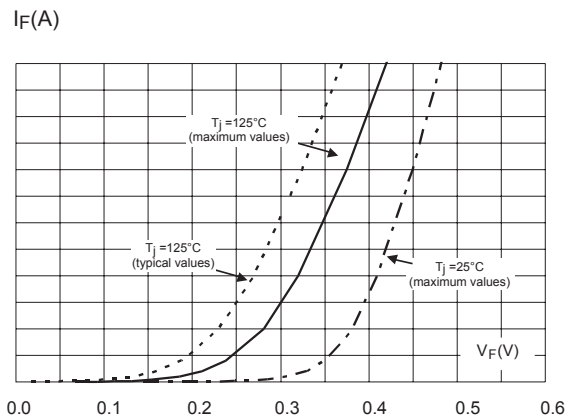

Figure 9. Forward voltage drop versus forward current (typical values)

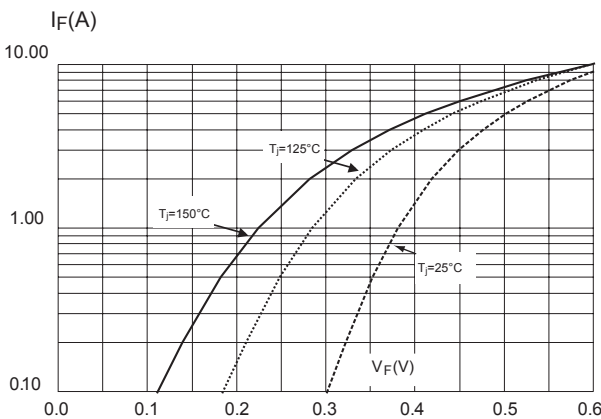

Figure 10. Thermal resistance junction to ambient versus copper surface area under each lead

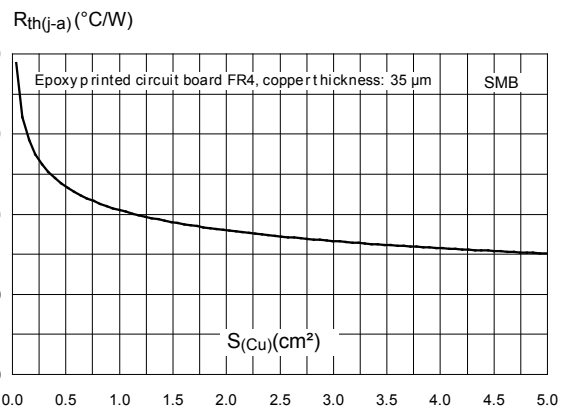
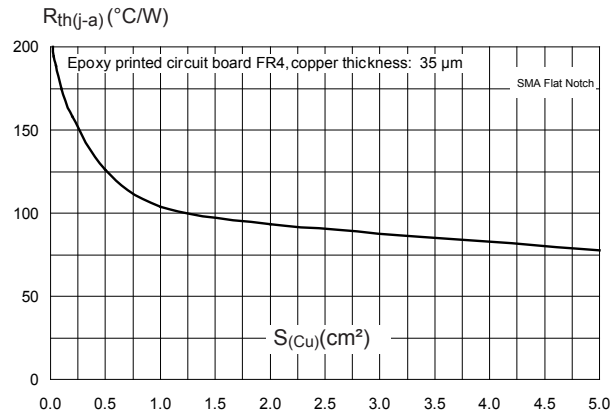

Figure 11. Thermal resistance junction to ambient versus copper surface under each lead (SMA Flat Notch)



2 Package information

In order to meet environmental requirements, ST offers these devices in different grades of **ECOPACK** packages, depending on their level of environmental compliance. ECOPACK specifications, grade definitions and product status are available at: www.st.com. ECOPACK is an ST trademark.

2.1 SMB package information

- Epoxy meets UL94, V0
- Lead-free package

Figure 12. SMB package outline

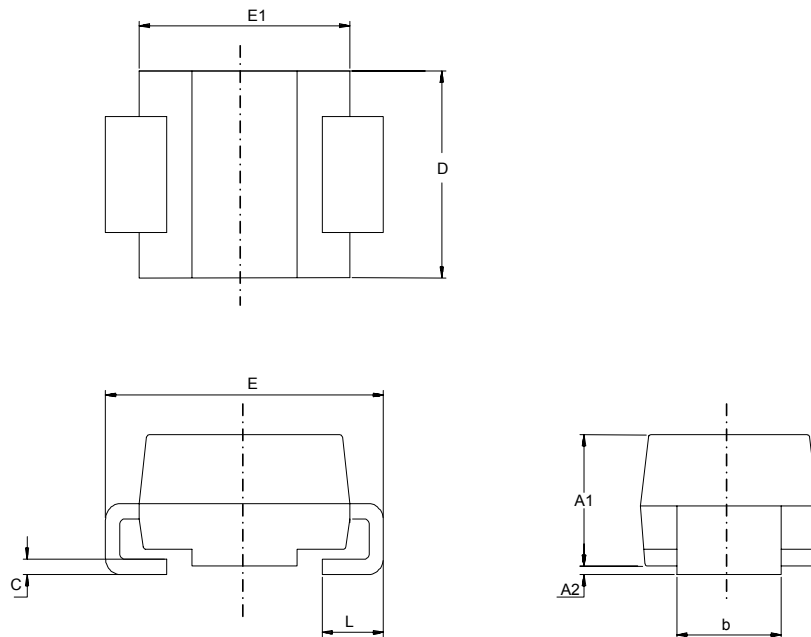
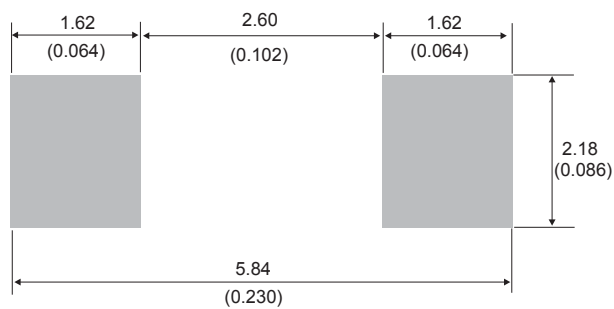

Table 4. SMB package mechanical data

Ref.	Dimensions			
	Millimeters		Inches (for reference only)	
	Min.	Max.	Min.	Max.
A1	1.90	2.45	0.074	0.097
A2	0.05	0.20	0.001	0.008
b	1.95	2.20	0.076	0.087
c	0.15	0.40	0.005	0.016
D	3.30	3.95	0.129	0.156
E	5.10	5.60	0.200	0.221
E1	4.05	4.60	0.159	0.182
L	0.75	1.50	0.029	0.060

Figure 13. SMB recommended footprint



2.2 SMA Flat Notch package information

- Epoxy meets UL94, V0
- Cooling method: by conduction (C)
- Band indicates cathode

Figure 14. SMA Flat Notch package outline

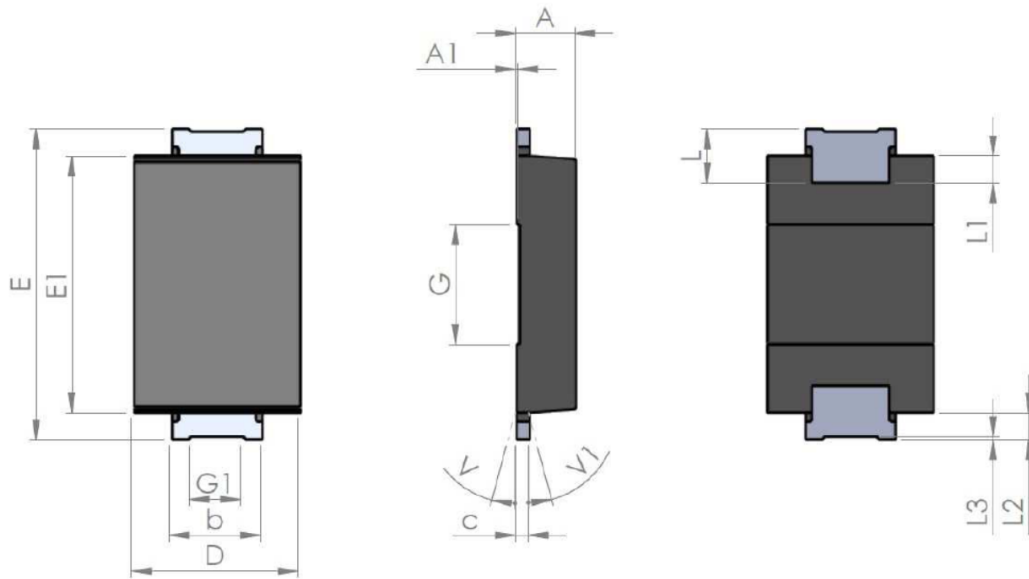
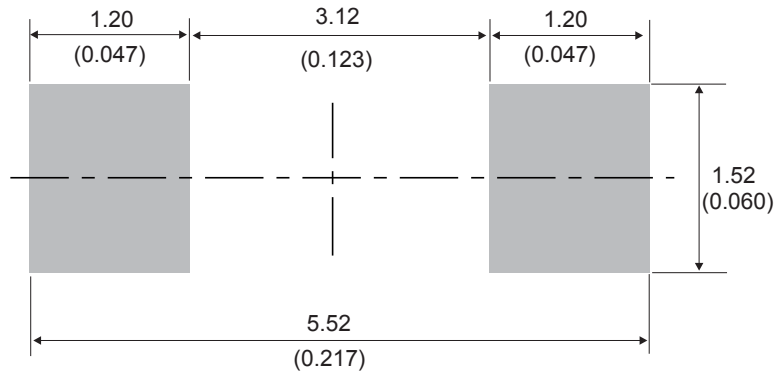

Table 5. SMA Flat Notch package mechanical data

Ref.	Dimensions					
	Millimeters			Inches (for reference only)		
	Min.	Typ.	Max.	Min.	Typ.	Max.
A1	0.90		1.10	0.035		0.044
A1		0.05			0.002	
b	1.25		1.65	0.049		0.065
C	0.15		0.40	0.005		0.016
D	2.25		2.90	0.088		0.115
E	5.00		5.35	0.196		0.211
E1	3.95		4.60	0.155		0.182
G		2.00			0.079	
G1		0.85			0.033	
L	0.75		1.20	0.029		
L1		0.45			0.018	
L2		0.45			0.018	
L3		0.05			0.002	
V			8°			8°
V1			8°			8°

Figure 15. SMA Flat Notch recommended footprint in mm (inches)



3 Ordering information

Table 6. Ordering information

Order code	Marking	Package	Weight	Base qty.	Delivery mode
STPS2L25U	G23	SMB	0.107 g	2500	Tape and reel
STPS2L25AFN	A22	SMA Flat Notch	0.039 g	10 000	Tape and reel

Revision history

Table 7. Document revision history

Date	Version	Changes
Jul-2003	4A	Last update.
08-Feb-2007	5	Reformatted to current standard. Added ECOPACK statement. Added SMB flat package.
09-Oct-2018	6	Updated Table 1 . Absolute ratings (limiting values at 25 °C, unless otherwise specified) and Figure 3 . Normalized avalanche power derating versus junction temperature ($T_j = 125\text{ °C}$). Removed SMB flat package.
27-Sep-2019	7	Added Section 2.2 SMA Flat Notch package information.

IMPORTANT NOTICE – PLEASE READ CAREFULLY

STMicroelectronics NV and its subsidiaries (“ST”) reserve the right to make changes, corrections, enhancements, modifications, and improvements to ST products and/or to this document at any time without notice. Purchasers should obtain the latest relevant information on ST products before placing orders. ST products are sold pursuant to ST’s terms and conditions of sale in place at the time of order acknowledgement.

Purchasers are solely responsible for the choice, selection, and use of ST products and ST assumes no liability for application assistance or the design of Purchasers’ products.

No license, express or implied, to any intellectual property right is granted by ST herein.

Resale of ST products with provisions different from the information set forth herein shall void any warranty granted by ST for such product.

ST and the ST logo are trademarks of ST. For additional information about ST trademarks, please refer to www.st.com/trademarks. All other product or service names are the property of their respective owners.

Information in this document supersedes and replaces information previously supplied in any prior versions of this document.

© 2019 STMicroelectronics – All rights reserved