

M8 female 90° snap-in with cable LED

PUR 3x0.25 bk UL/CSA+drag chain 3m

M8

Female 90° with LED

3-pole with 2 × LED (PNP)

Snap In

Plastic housings with good resistance against chemicals and oils. The resistance to aggressive media should be individually tested for your application. Further details on request.

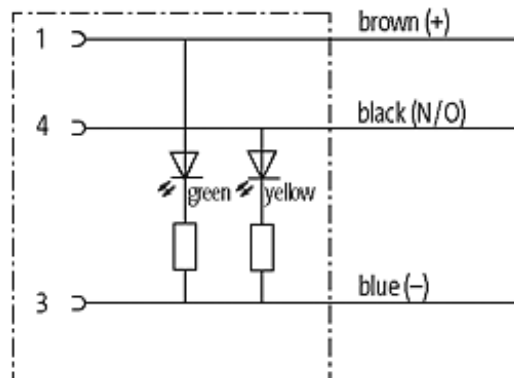
[Link to Product](#)**Illustration**

Female

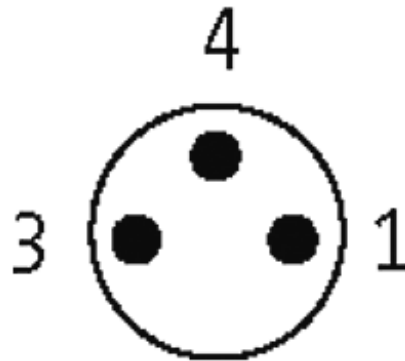

Product may differ from Image