



CIRCUIT-BREAKER SZ S00, FOR MOTOR PROTECTION, CLASS 10, A-REL.1.1...1.6A, N-RELEASE 21A, SCREW CONNECTION, STANDARD SW. CAPACITY, W. TRANSVERSE AUX. SWITCH 1NO+1NC

product brand name		SIRIUS
Product designation		3RV2 circuit breaker

General technical data:		
Active power loss total typical	W	6
Insulation voltage		
• with degree of pollution 3 Rated value	V	690
Shock resistance		
• acc. to IEC 60068-2-27		25g / 11 ms
Surge voltage resistance Rated value	kV	6
Mechanical service life (switching cycles)		
• of the main contacts typical		100 000
• of the auxiliary contacts typical		100 000
Electrical endurance (switching cycles)		
• typical		100 000
Temperature compensation	°C	-20 ... +60
Size of contactor can be combined company-specific		S0
Protection class IP		
• on the front		IP20
• of the terminal		IP20
Type of protection		Increased safety
Equipment marking		
• acc. to DIN EN 81346-2		Q

Main circuit:		
Number of poles for main current circuit		3

Adjustable response value current of the current-dependent overload release	A	1.1 ... 1.6
Operating voltage		
• Rated value	V	690
• at AC-3 Rated value maximum	V	690
Operating frequency Rated value	Hz	50 ... 60
Operating current Rated value	A	1.6
Operating current		
• at AC-3		
— at 400 V Rated value	A	1.6
Operating power		
• at AC-3		
— at 230 V Rated value	W	250
— at 400 V Rated value	W	550
— at 500 V Rated value	W	750
— at 690 V Rated value	W	1 100
Operating frequency		
• at AC-3 maximum	1/h	15

Auxiliary circuit:

Number of NC contacts		
• for auxiliary contacts		1
Number of NO contacts		
• for auxiliary contacts		1
Number of CO contacts		
• for auxiliary contacts		0
Product expansion Auxiliary switch		Yes
Design of the auxiliary switch		transverse
Operating current of the auxiliary contacts at AC-15		
• at 24 V	A	2
• at 120 V	A	0.5
• at 125 V	A	0.5
• at 230 V	A	0.5
Operating current of the auxiliary contacts at DC-13		
• at 24 V	A	1
• at 60 V	A	0.15

Protective and monitoring functions:

Trip class		CLASS 10
Design of the overload circuit breaker		thermal
Operational short-circuit current breaking capacity (Ics) with AC		
• at 240 V Rated value	kA	100
• at 400 V Rated value	kA	100

<ul style="list-style-type: none"> • at 500 V Rated value • at 690 V Rated value 	kA	100
<ul style="list-style-type: none"> • at 500 V Rated value • at 690 V Rated value 	kA	100
Maximum short-circuit current breaking capacity (Icu)		
<ul style="list-style-type: none"> • with AC at 240 V Rated value • with AC at 400 V Rated value • with AC at 500 V Rated value • with AC at 690 V Rated value 	kA	100
	kA	100
	kA	100
	kA	100
Breaking capacity short-circuit current (Icn)		
<ul style="list-style-type: none"> • with 1 current path for DC at 150 V Rated value • with 2 current paths in series for DC at 300 V Rated value • with 3 current paths in series for DC at 450 V Rated value 	kA	10
	kA	10
	kA	10
Response value current of the instantaneous short-circuit release	A	21

UL/CSA ratings:

Full-load current (FLA) for three-phase AC motor		
<ul style="list-style-type: none"> • at 480 V Rated value • at 600 V Rated value 	A	1.6
	A	1.6
yielded mechanical performance [hp]		
<ul style="list-style-type: none"> • for single-phase AC motor at 230 V Rated value • for three-phase AC motor at 460/480 V Rated value • for three-phase AC motor at 575/600 V Rated value 	metric hp	0.1
	metric hp	0.75
	metric hp	0.75
Contact rating of the auxiliary contacts acc. to UL		C300 / R300

Short-circuit:

Product function Short circuit protection		Yes
Design of the short-circuit trip		magnetic
Design of the fuse link		
<ul style="list-style-type: none"> • for short-circuit protection of the auxiliary switch required 		Fuse gL/gG: 10 A, miniature circuit breaker C 6 A (short-circuit current I _k < 400 A)
Design of the fuse link for IT network for short-circuit protection of the main circuit		
<ul style="list-style-type: none"> • at 500 V • at 690 V 		gL/gG 20 A gL/gG 16 A

Installation/ mounting/ dimensions:

mounting position		any
Mounting type		screw and snap-on mounting onto 35 mm standard mounting rail according to DIN EN 60715
Height	mm	97

Width	mm	45
Depth	mm	96
Required spacing		
<ul style="list-style-type: none"> • with side-by-side mounting <ul style="list-style-type: none"> — forwards — Backwards — upwards — downwards — at the side • for grounded parts <ul style="list-style-type: none"> — forwards — Backwards — upwards — at the side — downwards • for live parts <ul style="list-style-type: none"> — forwards — Backwards — upwards — downwards — at the side 	mm	0 0 50 50 0 0 0 50 30 50 0 0 50 50 30

Connections/ Terminals:		
Type of electrical connection		
<ul style="list-style-type: none"> • for main current circuit • for auxiliary and control current circuit 		screw-type terminals screw-type terminals
Arrangement of electrical connectors for main current circuit		Top and bottom
Product function		No
<ul style="list-style-type: none"> • removable terminal for auxiliary and control circuit 		
Type of connectable conductor cross-section		
<ul style="list-style-type: none"> • for main contacts <ul style="list-style-type: none"> — single or multi-stranded — finely stranded with core end processing • for AWG conductors for main contacts • for auxiliary contacts <ul style="list-style-type: none"> — single or multi-stranded — finely stranded with core end processing • for AWG conductors for auxiliary contacts 		2x (0,75 ... 2,5 mm ²), 2x 4 mm ² 2x (0.5 ... 1.5 mm ²), 2x (0.75 ... 2.5 mm ²) 2x (18 ... 14), 2x 12 2x (0,5 ... 1,5 mm ²), 2x (0,75 ... 2,5 mm ²) 2x (0.5 ... 1.5 mm ²), 2x (0.75 ... 2.5 mm ²) 2x (20 ... 16), 2x (18 ... 14)
Tightening torque		
<ul style="list-style-type: none"> • for main contacts with screw-type terminals 	N·m	0.8 ... 1.2
Design of screwdriver shaft		Diameter 5 to 6 mm

Design of the thread of the connection screw		
<ul style="list-style-type: none"> • for main contacts 		M3
<ul style="list-style-type: none"> • of the auxiliary and control contacts 		M3

Safety related data:

B10 value with high demand rate acc. to SN 31920		50 000
Proportion of dangerous failures		
<ul style="list-style-type: none"> • with low demand rate acc. to SN 31920 	%	40
<ul style="list-style-type: none"> • with high demand rate acc. to SN 31920 	%	40
Failure rate [FIT] with low demand rate acc. to SN 31920	FIT	50
T1 value for proof test interval or service life acc. to IEC 61508	y	10
Protection against electrical shock		finger-safe

Mechanical data:

Size of the circuit-breaker		S00
------------------------------------	--	-----

Ambient conditions:





Installation altitude at height above sea level maximum	m	2 000
Ambient temperature		
<ul style="list-style-type: none"> • during operation 	°C	-20 ... +60
<ul style="list-style-type: none"> • during storage 	°C	-50 ... +80
<ul style="list-style-type: none"> • during transport 	°C	-50 ... +80
Relative humidity during operation	%	10 ... 95





Display:

Display version		
<ul style="list-style-type: none"> • for switching status 		Handle

Certificates/ approvals:

General Product Approval				Declaration of Conformity	Test Certificates
 CCC	 CSA	 UL		 EG-Konf.	Type Test Certificates/Test Report

Test Certificates		Shipping Approval			
Special Test Certificate	Declaration of the Compliance with the order	 ABS	 BUREAU VERITAS	 DNV	 GL

Shipping Approval				other	
 LRS	 PRS	 RINA	 RMRS	Environmental Confirmations	Confirmation

other	
 VDE	other

Further information

Information- and Downloadcenter (Catalogs, Brochures,...)

<http://www.siemens.com/industrial-controls/catalogs>

Industry Mall (Online ordering system)

<http://www.siemens.com/industrymall>

Cax online generator

<http://support.automation.siemens.com/WW/CAXorder/default.aspx?lang=en&mlfb=3RV20111AA15>

Service&Support (Manuals, Certificates, Characteristics, FAQs,...)

<http://support.automation.siemens.com/WW/view/en/3RV20111AA15/all>

Image database (product images, 2D dimension drawings, 3D models, device circuit diagrams, EPLAN macros, ...)

http://www.automation.siemens.com/bilddb/cax_de.aspx?mlfb=3RV20111AA15&lang=en

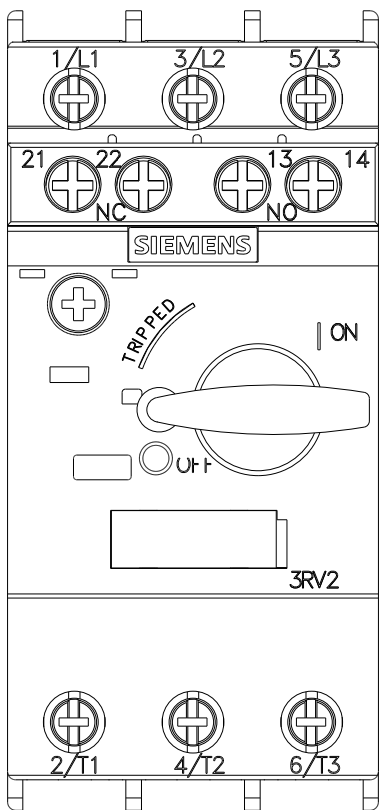
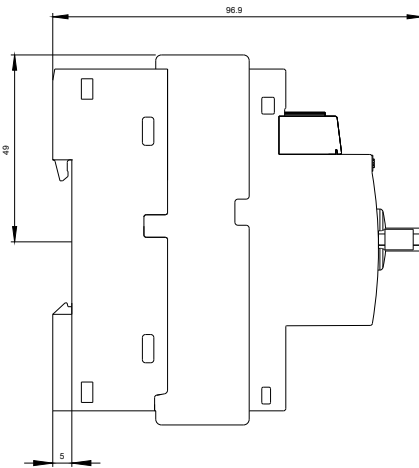
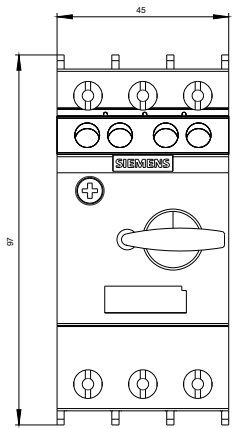

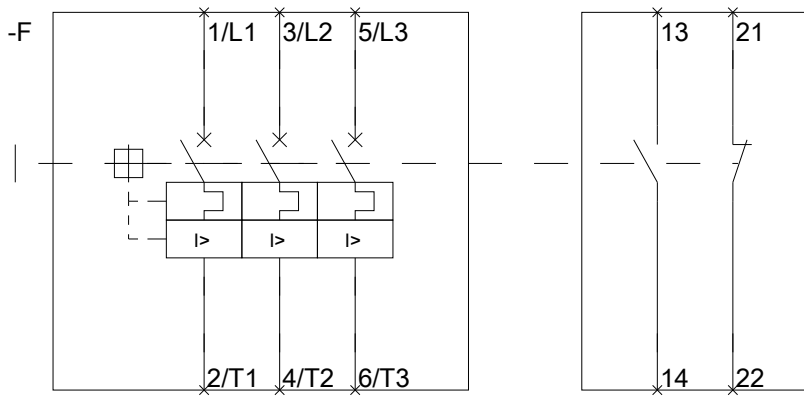

last modified:

11.03.2015