

■ MIL-DTL-26482 SERIES I  
HE 301 • VG95328









**Amphenol**  
Socapex



## PT/451 Products

Subminiature cylindrical connectors  
*Connecteurs circulaires subminiatures*

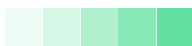
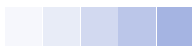

	<b>MAIN CHARACTERISTICS</b>	
	Presentation .....	4
	Applications .....	4
	General Characteristics .....	5
	<b>TECHNICAL CHARACTERISTICS</b>	
	PT/451 mated connectors section .....	6
	Mechanical characteristics .....	7
	Environmental characteristics .....	7
	Electrical characteristics .....	8
	Contact dimensions and wire sizes .....	8
	Coding system / Alternate insert position .....	9
	<b>CONNECTORS ORDERING INFORMATION</b>	
	Insert arrangements .....	10
	Shells and backshells, possible combinations .....	12
	How to order .....	14
	Cross references chart .....	18
	<b>OVERALL DIMENSIONS</b>	
	Square flange receptacle 02 type .....	20
	Square flange receptacle 00 type .....	20
	Inline receptacle 01 type .....	24
	Jam nut receptacle 07 type .....	28
	Plug 06, G06, 08 type .....	31
	Receptacle with locking ring 09 type .....	38
	Receptacle with PCB contacts .....	38
	Hermetic receptacle .....	40
	Through bulkhead receptacle PTB type .....	41
	Connectors to order without backshell .....	42
	PTSA backshell .....	44
	RJ45 solutions .....	45
	<b>ACCESSORIES</b>	
	Protective cap .....	52
	Contacts and sealing plugs .....	56
	Dummy receptacle, panel gasket, plastic dust cap .....	56
	Heatshrink moulded piece for rear accessory .....	57
	Nut ring for square flange receptacle .....	57
	<b>INSTALLATION - IMPLEMENTATION</b>	
	Panel drilling .....	58
	Panel thickness .....	58
	Coupling torque value .....	58
	PCB drillings .....	59
	<b>CRIMPING OPERATION</b>	
	Tools .....	62
	Procedure .....	63

## PRINCIPALES CARACTÉRISTIQUES

Présentation .....	4
Applications .....	4
Caractéristiques générales .....	5

## CARACTÉRISTIQUES TECHNIQUES

Coupe de connecteurs PT/451 assemblés .....	6
Caractéristiques mécaniques .....	7
Caractéristiques environnementales .....	7
Caractéristiques électriques .....	8
Dimensions des contacts et taille des conducteurs .....	8
Système de codage / Orientation de l'isolant .....	9

## INFORMATIONS POUR DEFINIR VOS REFERENCES

Arrangements de contacts .....	10
Boîtiers et raccords, combinaisons possibles .....	12
Comment commander .....	14
Tableaux d'équivalence .....	18

## DIMENSIONS GÉNÉRALES

Embase carrée type 02 .....	20
Embase carrée type 00 .....	20
Prolongateur type 01 .....	24
Embase à écrou type 07 .....	28
Fiche type 06, G06, 08 .....	31
Embase à écrou type 09 .....	38
Embase avec contacts à piquer .....	38
Embase hermétique .....	40
Embase traversée de cloison type PTB .....	41
Fiche et embase sans raccord arrière .....	42
Raccord PTSA .....	44
Solutions RJ45 renforcées .....	45

## ACCESSOIRES

Bouchon de protection .....	52
Contacts et obturateurs .....	56
Embase de repos, joint de panneau, bouchon de protection plastique .....	56
Manchon thermorétractable pour accessoire arrière .....	57
Contre plaque pour embase à collerette carrée .....	57

## INSTALLATION - MISE EN OEUVRE

Perçage de panneau .....	58
Épaisseur de panneau .....	58
Couple de serrage .....	58
Perçage des circuits imprimés .....	59

## OPÉRATION DE SERTISSAGE

Outils .....	62
Procédure .....	63



## Presentation / *Présentation*

You will find in this document the PT/451 connectors in accordance with the American MIL-DTL-26482 series I standard in crimp, solder, wire wrap, PCB versions, with different sealing levels which are well known in aeronautics, military and industrial applications. PT/451 Series provides you with a multitude of possibilities through their different backshell possibilities, contact terminations, insert arrangements.

The same product can be ordered with different designations. The standard P/N includes both connector body and rear accessory. Please refer to PT and 451 ordering information on pages 14 to 17 to create your own part number.

- For specific needs, you can order the connector body without rear accessory. In this case, refer to page 43 for specific ordering information.
- We do not provide connectors with MS marking. Please have a look at the cross references chart mentioned on pages 18 and 19 to define your Amphenol equivalent part numbers.

*Vous trouverez dans ce document les connecteurs PT/451 conformes à la norme américaine MIL-DTL-26482 série I en version à sertir, à souder, à wrapper ou à piquer avec différents niveaux d'étanchéité, utilisés pour les applications aéronautiques, militaires et industrielles. La série PT/451 vous offre une gamme étendue de connecteurs proposant différentes possibilités de raccords, de terminaisons de contacts et arrangements de contacts.*

*Vous pouvez commander le même produit sous différentes désignations. La référence standard correspond au connecteur avec son raccord arrière. Veuillez vous référer aux pages 14 à 17 pour définir vos propres références.*

- *En fonction de vos besoins, vous pouvez commander le connecteur sans raccord arrière. Dans ce cas, reportez vous à la page 43 pour définir les références.*
- *Nous ne réalisons pas le marquage MS. Veuillez ainsi vous référer au tableau comparatif pages 18 et 19 pour définir vos références Amphenol équivalentes.*

## Applications / *Applications*

### Industrial and military applications / *Applications industrielles et militaires*

- |                                 |   |
|---------------------------------|---|
| ■ Outdoor Industry Applications | ■ <i>Applications industrielles extérieures</i>     |
| ■ Oil & Gas                     | ■ <i>Recherche et prospection de pétrole et gaz</i> |
| ■ RMT                           | ■ <i>Industrie ferroviaire</i>                      |
| ■ C4ISR                         | ■ <i>C4ISR</i>                                      |
| ■ Ground Vehicles               | ■ <i>Véhicules de terrain</i>                       |
| ■ Measure / Instrumentation     | ■ <i>Mesure / Instrumentation</i>                   |





## General Characteristics / *Caractéristiques générales*

### Shell Material / *Matière du boîtier*

- Aluminium alloy
- Carbon steel (for hermetic receptacles)
- Stainless steel (please consult us)
- *Alliage d'Aluminium*
- *Acier (pour embases hermétiques)*
- *Acier inoxydable (veuillez nous contacter)*

### Shell Finish / *Protection du boîtier*

- Olive drab cadmium plating
- Electroless nickel plating - RoHS compliant
- Tin plating (for hermetic receptacles)
- Others, please consult us (bright cadmium, black anodic coating, black electrophoretic coating, cadmium free versions)
- *Revêtement cadmié vert-olive*
- *Revêtement Nickel - Conforme RoHS*
- *Revêtement étamé (pour embases hermétiques)*
- *Autres, veuillez nous consulter (cadmium blanc, anodisation noire, électrophorèse noire, versions sans cadmium)*

9 shell sizes from 8 to 24 / *9 tailles de boîtiers de 8 à 24*

### Contacts / *Contacts*

- 36 different arrangements of contacts
- Contacts size 20 and 16
- Signal (7,5 A): wire soldering, crimp, PCB, wire wrap
- Power (13 A): wire soldering, crimp, PCB
- *36 arrangements différents de contacts*
- *Contacts tailles 20 et 16*
- *Signal (7,5 A) : à souder sur fil, à sertir, à piquer, à wrapper*
- *Puissance (13 A) : à souder sur fil, à sertir, à piquer*

### EMI/RFI protection / *Protection EMI/RFI*

- Grounding ring on the plug shell for PTG06 / 45136 type
- *Bague de blindage sur le corps de fiche pour les types PTG06 / 45136*



PT/451 connectors section / *Coupe de connecteurs PT/451*

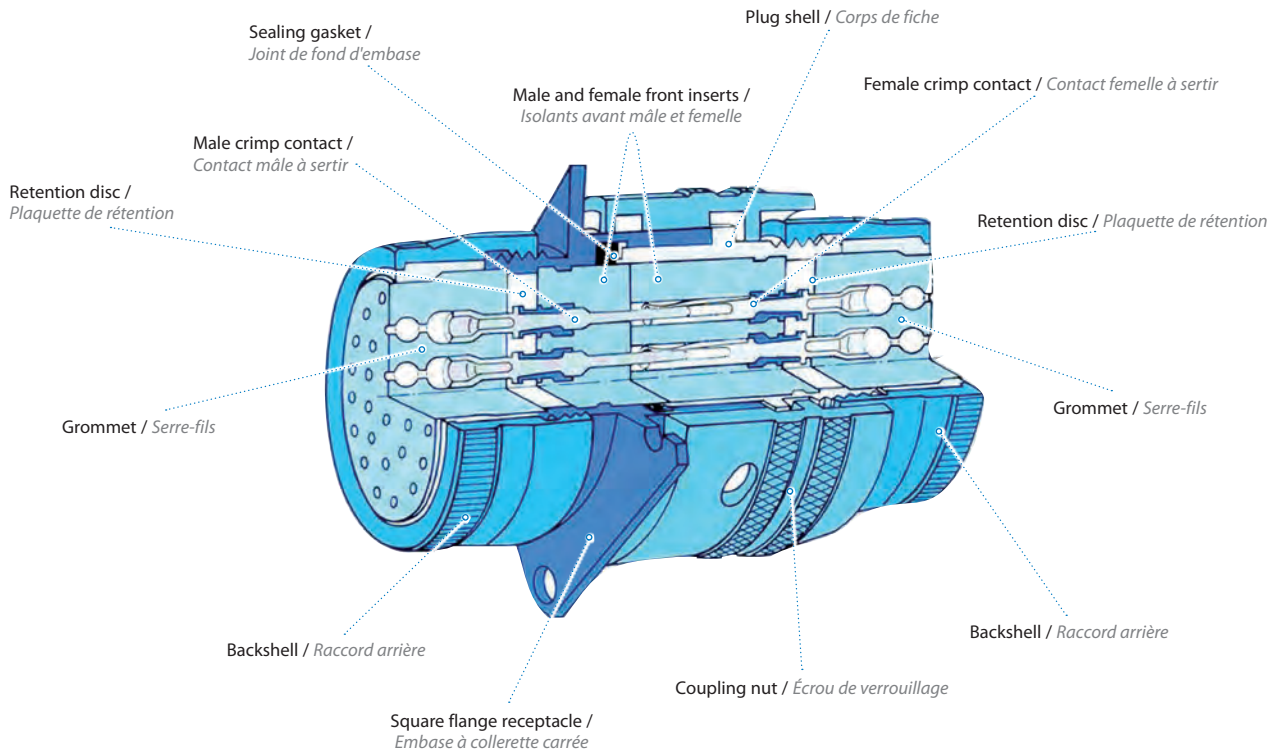

**Crimp version section (mated pair)**  
*Coupe de version à sertir (connecteurs assemblés)*



**PCB receptacle section**  
*Coupe d'embase PCB*

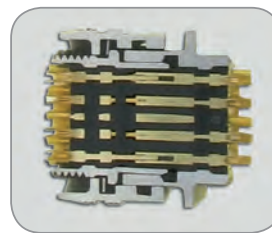

**Solder version section (mated pair)**  
*Coupe de version à souder (connecteurs assemblés)*

## Mechanical characteristics / *Caractéristiques mécaniques*

### Insert and grommet / *Isolant et serre-fils*

#### Solder and PCB versions:

- 36 different insert arrangements
- Insert in Neoprene elastomer (Insert in Viton: please consult us)
- Rear elastomer grommet independent of the insert to allow soldering process

#### Crimp version:

- 25 different insert arrangements
- Insert in three parts: front insert, retention disc and grommet
- Retention of the contacts in the insert ensured by a hard retention disc

#### Versions à souder et à piquer :

- 36 arrangements d'isolants différents
- Isolant en néoprène élastomère (Isolant en Viton : nous consulter)
- Serre-fils indépendant de l'isolant pour permettre le process de soudure

#### Version à sertir :

- 25 arrangements d'isolants différents
- Isolant en trois parties : isolant avant, plaquette de rétention et serre-fils.
- Le maintien des contacts dans l'isolant est assuré par une plaquette de rétention

### Contacts / *Contacts*

#### Solder and PCB versions:

- Size 20 and 16 non-removable gold plated contacts

#### Crimp version:

- Size 20 and 16 crimp removable gold plated contacts, front release (delivered non-mounted in the insert to allow crimping process)

#### Versions à souder et à piquer :

- Contacts dorés non démontables taille 20 et 16

#### Version à sertir :

- Contacts à sertir dorés, démontables (par l'avant) taille 20 et 16 (livrés non montés dans l'isolant pour permettre l'opération de sertissage)

#### Contact retention in the insert:

##### *Rétention des contacts dans l'isolant :*

	Size 20 / Taille 20	Size 16 / Taille 16
Solder / A souder	67 N	110 N
Crimp / A sertir	67 N	110 N

**Durability:** 500 cycles (full mating - unmating)

**Endurance mécanique :** 500 cycles (verrouillage - déverrouillage)

## Environmental characteristics / *Caractéristiques environnementales*

- **Operating temperature:** -55°C / +125°C
- **Salt spray exposure:** from 48h (nickel plating) to 500h (olive drab cadmium plating)
- **Sealing:** air leakage <16 cm<sup>3</sup> per hour under 2 bar of differential pressure (for solder and PCB versions)
- **Hermeticity:** leak ≤ 10<sup>-6</sup> cm<sup>3</sup>.s<sup>-1</sup> under 1 bar differential pressure (for hermetic versions)
- **Température d'utilisation :** -55°C / +125°C
- **Résistance au brouillard salin :** de 48h (traitement nickel) à 500h (traitement cadmium vert olive)
- **Étanchéité :** fuite <16 cm<sup>3</sup> par heure sous 2 bar de pression différentielle (en version à souder et PCB)
- **Herméticité :** fuite ≤ 10<sup>-6</sup> cm<sup>3</sup>.s<sup>-1</sup> sous 1 bar de pression différentielle (pour les versions hermétiques)

## Electrical characteristics / *Caractéristiques électriques*

	Size 20 contacts (ø 1mm) <i>Contacts taille 20</i>	Size 16 contacts (ø 1,57mm) <i>Contacts taille 16</i>	
		Service 1	Service 2
Recommended operating voltage at sea level <i>Tension de service recommandée au niveau de la mer</i>	600 Vrms	600 Vrms	1000 Vrms
Test voltage at sea level <i>Tension d'essai au niveau de la mer</i>	1500 Vrms	1500 Vrms	2300 Vrms
Test voltage at 21000m <i>Tension d'essai à 21000m</i>	375 Vrms	375 Vrms	500 Vrms
Current rating per contact* <i>Intensité max par contact*</i>	7.5 A	13 A	
Insulation resistance at ambient <i>Résistance d'isolement (air ambiant)</i>	≥ 5000 MOhm	≥ 5000 MOhm	
Contact resistance at ambient <i>Résistance de contact (air ambiant)</i>	≤ 2 mOhm	≤ 1.5 mOhm	

\*: Current rating must not be applied at the same time to 50% of the contacts of the connector.

\*: L'intensité maximale ne doit pas être appliquée en même temps à plus de 50% des contacts d'un même connecteur.

## Contact dimensions and wire sizes

### *Dimensions des contacts et taille des conducteurs*

Contacts			Gauge Mil-W-5086	Section (mm <sup>2</sup> )	Diameter in mm / <i>Diamètre en mm</i>			
					on conductor / <i>sur âme</i>		on insulator / <i>sur isolant</i>	
Type	Size / <i>Taille</i>	ø in mm			min.	max.	min.	max.
Solder / <i>A souder</i>	20	1	22 to 18	0.38-0.93	-	1.3	1.2	2.4
	16	1.57	20 to 14	0.60-1.91	-	1.6	1.6	2.8
Crimp / <i>A sertir</i>	20	1	24* to 18	0.22*-0.93	0.6	1.3	1.2	2.4
	16	1.57	22 to 14	0.38-1.91	-	1.6	1.6	2.8

\*: Possible when used with reducing sleeves (see page 56 for ordering information).

\*: Possible lorsqu'il est utilisé avec des manchons réducteurs (voir page 56 pour commander).

## Coding system / Alternate insert position

### Système de codage / Orientation de l'isolant

To avoid cross-plugging issues in applications requiring the use of more than one PT/451 connector of the same size and arrangement, alternate coding positions are available as indicated in the chart below.

As shown in the diagram below, the front face of the pin insert is rotated within the shell in a clockwise direction from the main shell key.

*Afin d'éviter les problèmes d'inversion de branchement dans les applications qui nécessitent plus d'un connecteur PT/451 de la même taille et avec le même arrangement, il est possible de configurer des positions de codage tel qu'indiqué dans le tableau ci-dessous. Les schémas ci-dessous montrent que la face avant de l'isolant mâle a été tournée dans le boîtier dans le sens des aiguilles d'une montre par rapport à la clé principale du boîtier.*

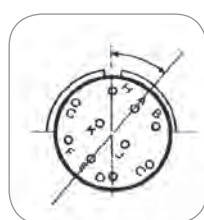

Position W

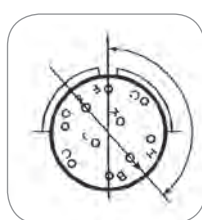

Position X

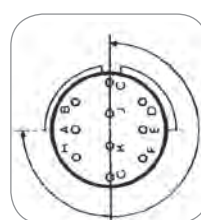

Position Y

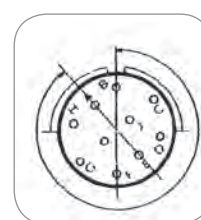

Position Z

Diagrams show front face of pin insert or rear face of socket insert  
*Vues de la face avant de l'isolant mâle ou de la face arrière de l'isolant femelle*

Shell size <i>Taille du boîtier</i>	Insert arrangement <i>Arrangement de contact</i>	Insert rotation (in degrees) / <i>Rotation de l'isolant (en degrés)</i>			
		W	X	Y	Z
8	8-2	58	122	-	-
8	8-3	60	210	-	-
8	8-3A	60	-	-	-
8	8-33	90	-	-	-
8	8-4	45	-	-	-
10	10-6	90	-	-	-
10	10-7	-	-	-	-
10	10-98	90	180	240	270
12	12-3	-	-	180	-
12	12-8	90	112	203	292
12	12-10	60	155	270	295
12	12-14	-	-	-	-
14	14-5	40	92	184	273
14	14-12	43	90	-	-
14	14-15	17	110	155	234
14	14-18	15	90	180	270
14	14-19	30	165	315	-
16	16-8	54	152	180	331

Shell size <i>Taille du boîtier</i>	Insert arrangement <i>Arrangement de contact</i>	Insert rotation (in degrees) / <i>Rotation de l'isolant (en degrés)</i>			
		W	X	Y	Z
16	16-23	158	270	-	-
16	16-26	60	-	275	338
18	18-11	62	119	241	340
18	18-30	180	193	285	350
18	18-32	85	138	222	265
20	20-16	238	318	333	347
20	20-24	70	145	215	290
20	20-25	72	144	216	288
20	20-27	72	144	216	288
20	20-39	63	144	252	333
20	20-41	45	126	225	-
22	22-21	16	135	175	349
22	22-32	72	145	215	288
22	22-34	62	142	218	298
22	22-36	72	144	216	288
22	22-41	39	135	264	-
22	22-55	30	142	226	314
24	24-61	90	180	270	324



45100RTxxx x * 50	HE30 L
45100RPaaxxx x * 50	HE30 L
45101Axxx x * 50	HE301B01A
45101ACxxx x * 50	HE301B01AC
45101Axxx x * PG50	HE301B01A
45101Exxx x * 50	HE301B01E
45101ECoxxx x * 50	HE301B01EC
45101Txxx x * 50	HE301B01T
45101Kxxx x * 50	HE301B01K
45101KMoxxx x * 50	HE301B01KM
45101Pxxx x * 50	HE301B01P
45101Jxxx x * 50	HE301B01J
45101Rxxx x * 50	HE301B01R
45101RCxxx x * 50	HE301B01RC
45101RTxxx x * 50	HE301B01RT
45101SKxxx x * 50	HE301B01SK

### Insert arrangements - Front view of male insert

### Arrangements de contacts - Vue face avant de l'isolant mâle

1	Insert arrangement reference / Arrangements de contacts	3	Number of contacts / Nombre de contacts
2	Service rating / Service	4	Contact size / Taille des contacts

08	1	<b>8-2</b>	<b>8-3</b>	<b>8-3A (8-98)</b>	<b>8-33</b>	<b>8-4</b>
	2	1	1	1	1	1
	3	2	3	3	3	4
	4	20	20	20	20	20

10	1	<b>10-6</b>	<b>10-98</b>	<b>10-7</b>
	2	1	1	1
	3	6	6	7
	4	20	20	20

12	1	<b>12-3</b>	<b>12-8</b>	<b>12-10</b>	<b>12-14</b>
	2	2	1	1	1
	3	3	8	10	14
	4	16	20	20	20

14	1	<b>14-5</b>	<b>14-12</b>	<b>14-15</b>	<b>14-18</b>	<b>14-19</b>
	2	2	1	1	1	1
	3	5	8 4	14 1	18	19
	4	16	20 16	20 16	20	20

16	1	<b>16-8</b>	<b>16-23</b>	<b>16-26</b>
	2	2	1	1
	3	8	22 1	26
	4	16	20 16	20

Amphenol

**H:** Available in hermetic version  
**H :** Disponible en version hermétique

**C:** Available in crimp version  
**C :** Disponible en version à sertir

**P:** For those arrangements, please contact us for available configurations. Only available with PT marking  
**P :** Pour ces arrangements, nous consulter pour les configurations possibles. Marquage PT seulement

Contact Legend / Légende des contacts

Symbol / Symbole	Contact size / Taille du contact
○	20
●	16

Top-runners / Les plus standard

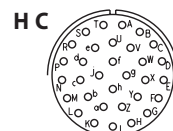
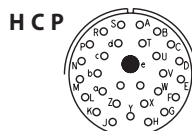
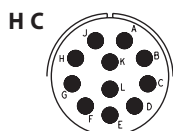

18	1	<b>18-11</b>	<b>18-30</b>	<b>18-32</b>
	2	2	1	1
	3	11	29	32
	4	16	20	20

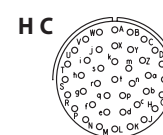
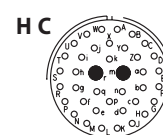
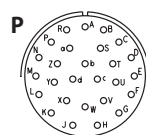
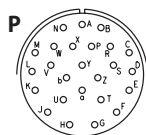
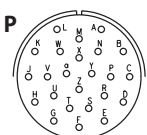
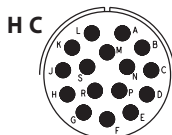

20	1	<b>20-16</b>	<b>20-24</b>	<b>20-25</b>	<b>20-27</b>	<b>20-39</b>	<b>20-41</b>
	2	2	1	1	1	1	1
	3	16	24	25	27	37	41
	4	16	20	20	20	20	16

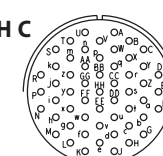
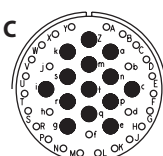
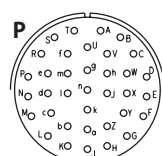
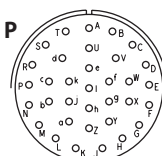
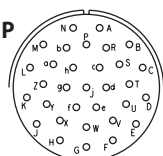
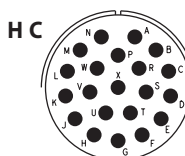

22	1	<b>22-21</b>	<b>22-32</b>	<b>22-34</b>	<b>22-36</b>	<b>22-41</b>	<b>22-55</b>
	2	2	1	1	1	1	1
	3	21	32	34	36	27	55
	4	16	20	20	20	20	16

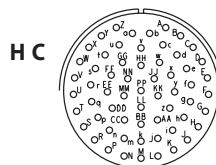

24	1	<b>24-61</b>
	2	1
	3	61
	4	20

- Caution: 8-3A and 8-3 insert arrangements are not intermatable
- All insert arrangements mentioned are available in solder version
- Contact us for availability of other insert arrangements

- Attention: les arrangements 8-3A et 8-3 ne peuvent pas s'accoupler
- Tous les arrangements de contacts existents en version à souder
- Veuillez nous contacter pour les arrangements ne figurant pas dans ce tableau



## Shells and backshells, possible combinations





*Boîtiers et raccords, combinaisons possibles*Solder version / *Version à souder*

	Simple backshell <i>Raccord simple</i>		Cable clamp backshell <i>Raccord serre-câble</i>		Sealed backshell <i>Raccord étanche</i>				Braid clamping backshell <i>Raccord pour reprise de tresse</i>	
										
PT 451	A A	E E	A (SR) AC	E (SR) EC	W J	P P	E (J) T	A (PG) A (PG)	G	E (SQ) G
00  Square flange receptacle <i>Embase à collerette carrée</i>	✓	✓	✓	✓	✓	✓	✓	✓		✓
01  Inline receptacle <i>Prolongateur</i>	✓	✓	✓	✓	✓	✓	✓	✓		✓
02  Square flange receptacle without rear accessory possibility <i>Embase carrée sans possibilité de raccord</i>	PT02A/ PT02E/ PT02C 45102E  No rear accessory <i>Ne comporte pas de raccord</i>									
06  Straight plug / <i>Fiche droite</i>	✓	✓	✓	✓	✓	✓	✓	✓	✓	✓
07  Jam nut receptacle <i>Embase à fixation par écrou</i>	PT07A/ PT07C 45107A  No rear accessory <i>Ne com- porte pas de raccord</i>		✓	✓		✓				
09  Square flange receptacle with locking ring <i>Embase carrée à écrou</i>	PT09A 45109E  No rear accessory <i>Ne com- porte pas de raccord</i>									

	Cable clamp backshell <i>Raccord serre-câble</i>	Potting <i>Potting</i>	Braid clamping backshell <i>Raccord pour reprise de tresse</i>	
				
PT / 451	E(SR) / EC	P / P	G	PTSA
08  Plug for right angle backshell <i>Fiche pour raccord coudé</i>	✓	✓	✓	
G55  Straight plug / <i>Fiche droite</i>				✓

Crimp version / *Version à sertir*

	Simple backshell <i>Raccord simple</i>		Cable clamp backshell <i>Raccord serre-câble</i>	Sealed backshell <i>Raccord étanche</i>			Braid clamping backshell <i>Raccord pour reprise de tresse</i>
							
	RA	SE R	SE (SR) RC	SP RP	SE (J) RT	SE (PG) R (PG)	SE (SQ) RG
00  <i>Square flange receptacle Embase à collerette carrée</i>	✓	✓	✓	✓	✓	✓	✓
01  <i>Inline receptacle Prolongateur</i>	✓	✓	✓	✓	✓	✓	✓
02  <i>Square flange receptacle without rear accessory possibility Embase carrée sans possibilité de raccord</i>		PT02SE 45102R <i>No rear accessory Ne comporte pas de raccord</i>					
06  <i>Straight plug / Fiche droite</i>	✓	✓	✓	✓	✓	✓	✓ PTG06 / 45136
07  <i>Jam nut receptacle Embase à fixation par écrou</i>		✓	✓	✓			✓

	Cable clamp backshell <i>Raccord serre-câble</i>	Braid clamping backshell <i>Raccord pour reprise de tresse</i>
		
	SE (SR) RC	PTSA
08  <i>Plug for right angled backshell Fiche pour raccord coudé</i>	✓	
G55  <i>Straight plug / Fiche droite</i>		✓

Note: EK, KM, SK backshells are not indicated in these charts because they are not often used for new developments.  
 Note : Les raccords EK, KM, SK ne sont pas mentionnés dans ces tableaux car ils ne sont pas souvent utilisés pour les nouveaux développements.

## HOW TO ORDER - Amphenol Designation: PT

Solder, Crimp, PCB, wire wrap versions. Connector with rear accessory

PT Series	PT	00	E	12	10	P	-	-	-
<p><b>Shell type:</b>  <b>00:</b> Square flange receptacle with rear accessory possibility  <b>01:</b> Inline receptacle  <b>02:</b> Square flange receptacle without rear accessory possibility  <b>06:</b> Straight plug  <b>G06:</b> Straight plug with grounding ring for braid clamping backshell  <b>07:</b> Jam nut receptacle  <b>08:</b> Right angled plug  <b>09:</b> Square flange receptacle with locking ring  <b>I:</b> Solder mounting receptacle (hermetic version)  <b>B:</b> Through bulkhead receptacle</p> <p><b>Service class and rear accessory capability:</b>  <b>Solder version:</b>  <b>A:</b> Intermediate backshell  <b>Exception for PT02, PT07, PT09:</b> no rear accessory*  <b>E:</b> Backnut  <b>Exception for PT02:</b> no rear accessory*  <b>C:</b> Air leakage controlled for PT02 &amp; PT07, no rear accessory  <b>A + SR:</b> Cable clamp backshell delivered without grommet  <b>E + SR/J/SQ:</b> Backshell delivered with grommet (see «rear accessory particularity» for the backshell type)  <b>A+PG:</b> PG backshell (see «rear accessory particularity» for the description)  <b>W:</b> Sealing gland backshell - IP68  <b>P:</b> Backshell for potting  <b>G:</b> Braid soldering backshell  <b>H:</b> Hermetic version  <b>EK(x)*:</b> Immersion proof sealing gland backshell with strong cable grip  <b>KM(x)*:</b> Rain proof sealing gland backshell with strong cable grip and earth line</p> <p><b>Crimp version:</b>  <b>SE:</b> Backnut  <b>Exception for PT02:</b> no rear accessory (standard version)  <b>SE + SR/J/PG/SQ:</b> See «rear accessory particularity» for the backshell type  <b>SP:</b> Backshell for potting  <b>SK(x)*:</b> Immersion proof sealing gland backshell with strong cable grip</p> <p><b>Other versions:</b>  <b>Y/YS/GS:</b> PCB version (see page 38)  <b>MW:</b> Wire wrap version (see page 39)  <b>Blank:</b> for through bulkhead receptacle</p> <p><b>Shell size:</b> 8/10/12/14/16/18/20/22/24</p> <p><b>Contact insert arrangement:</b> See page 10 &amp; 11</p> <p><b>Contact type:</b>  <b>P:</b> Pin  <b>S:</b> Socket  <b>PS:</b> For through bulkhead receptacle</p> <p><b>Coding / Insert alternate positioning:</b>  Blank for normal or W, X, Y, Z (see coding system page 9)</p> <p><b>Rear accessory particularity:</b>  <b>SR:</b> Cable clamp backshell  <b>J:</b> Backnut for heatshrink moulded piece  <b>PG:</b> Straight adaptor terminated by a PG type plastic sealing gland  <b>SQ:</b> Braid clamping backshell</p> <p><b>Shell finish:</b>  Omit for standard olive drab cadmium. Hermetic connectors are all supplied with tin plated shells.  <b>01:</b> Bright cadmium  <b>02:</b> Black anodised - ROHS compliant  <b>023:</b> Electroless nickel - ROHS compliant</p>									

\*: Replace «x» after EK, KM or SK by the number of the corresponding gasket (refer to end of page 34).

†: PT02A and PT02E designations are equivalent



## COMMENT COMMANDER - Désignation Amphenol : PT

Versions à souder, à sertir, à piquer, à wrapper. Connecteur avec raccord arrière

Série PT	PT	00	E	12	10	P	-	-	-
<p><b>Type de boîtier :</b>  <b>00 :</b> Embase à collerette carrée avec possibilité de raccord  <b>01 :</b> Prolongateur  <b>02 :</b> Embase à collerette carrée sans possibilité de raccord  <b>06 :</b> Fiche droite  <b>G06 :</b> Fiche droite avec bague de masse pour raccord à reprise de tresse  <b>07 :</b> Embase à fixation par écrou  <b>08 :</b> Fiche coudée  <b>09 :</b> Embase à collerette carrée avec écrou de verouillage  <b>I :</b> Embase à fixation par brasage (version hermétique)  <b>B :</b> Traversée de cloison</p> <p><b>Type de raccord arrière :</b>  <b>Version à souder :</b>  <b>A :</b> Raccord intermédiaire  <b>Exception en PT02, PT07, PT09 :</b> sans possibilité de raccord arrière*  <b>E :</b> Ecrou serre-fils  <b>Exception en PT02 :</b> sans possibilité de raccord arrière*  <b>C :</b> Etanchéité contrôlée pour PT02 et PT07, sans possibilité de raccord arrière  <b>A + SR :</b> Serre câble fourni sans serre-fils  <b>E + SR/J/SQ :</b> Raccord fourni avec serre-fils (voir «particularité des raccords arrière» pour le type de raccord)  <b>A+PG :</b> Raccord PG (voir «particularité des raccords arrière» pour la description)  <b>W :</b> Raccord presse-étoupe - IP68  <b>P :</b> Raccord pour potting  <b>G :</b> Raccord pour reprise de tresse avec terminaison étamée pour soudure de la tresse  <b>H :</b> Version hermétique  <b>EK(x)* :</b> Raccord presse-étoupe étanche à l'immersion  <b>KM(x)* :</b> Raccord presse-étoupe étanche au ruissellement et continuité de masse</p> <p><b>Version à sertir :</b>  <b>SE :</b> Ecrou serre-fils  <b>Exception en PT02 :</b> sans possibilité de raccord arrière  <b>SE + SR/J/PG/SQ :</b> voir «particularité des raccords arrière» pour le type de raccord  <b>SP :</b> Raccord pour potting  <b>SK(x)* :</b> Raccord presse-étoupe étanche à l'immersion</p> <p><b>Autres versions :</b>  <b>Y/YS/GS :</b> Version à piquer sur circuit imprimé (voir page 38)  <b>MW :</b> Version à wrapper (voir page 39)  <b>Néant :</b> Pour traversée de cloison</p> <p><b>Taille de boîtier :</b> 8/10/12/14/16/18/20/22/24</p> <p><b>Arrangement de contact :</b> voir page 10 et 11</p> <p><b>Type de contact :</b>  <b>P :</b> Mâle  <b>S :</b> Femelle  <b>PS :</b> Pour traversée de cloison</p> <p><b>Codage / Orientation de l'isolant :</b>  Néant pour normal ou W, X, Y, Z (voir le système de codage page 9)</p> <p><b>Particularité des raccords arrière :</b>  <b>SR :</b> Serre-câble  <b>J :</b> Raccord pour pièce moulée thermorétractable  <b>PG :</b> Raccord intermédiaire raccordé à un presse-étoupe PG plastique  <b>SQ :</b> Raccord pour reprise de tresse</p> <p><b>Traitement du boîtier :</b>  Néant pour le cadmié vert olive. Les connecteurs hermétiques sont tous fournis avec un boîtier étamé.  <b>01 :</b> Cadmié blanc  <b>02 :</b> Oxydation anodique noire - conforme ROHS  <b>023 :</b> Nickel chimique - conforme ROHS</p>									

\* : Remplacer «x» après EK, KM ou SK par le numéro de joint correspondant (se référer au bas de la page 34).

.: Les désignations PT02A et PT02E sont équivalentes.

## HOW TO ORDER - NFL 54125 Designation: 451

Solder, Crimp, PCB, Wire wrap versions. Connector with rear accessory

<b>451 Series</b>	<b>451</b>	<b>00</b>	<b>EC</b>	<b>12</b>	<b>10</b>	<b>P</b>	<b>-</b>	<b>-</b>	<b>50</b>	<b>-</b>
-------------------	------------	-----------	-----------	-----------	-----------	----------	----------	----------	-----------	----------

**Shell type:**

- 00:** Square flange receptacle with rear accessory possibility
- 01:** Inline receptacle
- 02:** Square flange receptacle without rear accessory possibility
- 06:** Straight plug
- 36:** Straight plug with grounding ring for braid clamping backshell
- 07:** Jam nut receptacle
- 08:** Right angled plug
- 09:** Square flange receptacle with locking ring

**Service class and rear accessory capability:****Solder version:**

- A:** Intermediate backshell
- Exception for 451 07:** no rear accessory
- E:** Backnut
- Exception for 451 02 and 451 09:** no rear accessory
- A+PG:** PG backshell (see «rear accessory particularity» for the description)
- AC:** Cable clamp backshell delivered without grommet
- EC:** Cable clamp delivered with grommet
- J:** Sealing gland backshell - IP68
- T:** Backnut for heatshrink moulded piece
- P:** Backshell for potting
- G:** Braid clamping backshell
- EK(x)\*:** Immersion proof sealing gland backshell with strong cable grip
- KM(x)\*:** Rain proof sealing gland backshell with strong cable grip and earth line

**Crimp version:**

- R:** Backnut
- Exception for 451 02: no rear accessory
- R+PG:** PG backshell (see «rear accessory particularity» for the description)
- RA:** Intermediate backshell
- RC:** Cable clamp backshell
- RT:** Backnut for heatshrink moulded piece
- RP:** Backshell for potting
- RG:** Braid clamping backshell
- SK(x)\*:** Immersion proof sealing gland backshell with strong cable grip

**Other versions:**

- Y/YS/GS:** PCB version (see page 38)
- MW:** Wire wrap version (see page 39)
- Blank:** for through bulkhead receptacle

**Shell size:** 8/10/12/14/16/18/20/22/24**Contact insert arrangement:** See page 10 and 11**Contact type:**

- P:** Pin
- S:** Socket
- PS:** For through bulkhead receptacle

**Coding / Insert alternate positioning:**

Blank for normal or W, X, Y, Z (see coding system page 9)

**Rear accessory particularity:**

- PG:** Straight adaptor terminated by a PG type plastic sealing gland

**50:** Obligatory suffix**Shell finish:**

- Blank for standard olive drab cadmium.
- 01:** Bright cadmium
- 02:** Black anodised - ROHS compliant
- 70:** Electroless nickel - ROHS compliant

\*: Replace «x» after EK, KM or SK by the number of the corresponding gasket (refer to end of page 34).

## COMMENT COMMANDER - Désignation NFL 54125: 451

Versions à souder, à sertir, à piquer, à wrapper. Connecteur avec raccord arrière

<b>Série 451</b>	<b>451</b>	<b>00</b>	<b>EC</b>	<b>12</b>	<b>10</b>	<b>P</b>	<b>-</b>	<b>-</b>	<b>50</b>	<b>-</b>
<p><b>Type de boîtier :</b>  <b>00 :</b> Embase à collerette carrée avec possibilité de raccord  <b>01 :</b> Prolongateur  <b>02 :</b> Embase à collerette carrée sans possibilité de raccord  <b>06 :</b> Fiche droite  <b>36 :</b> Fiche droite avec bague de masse pour raccord à reprise de tresse  <b>07 :</b> Embase à fixation par écrou  <b>08 :</b> Fiche coudée  <b>09 :</b> Embase à collerette carrée avec écrou de verouillage</p> <p><b>Type de raccord arrière :</b></p> <p><b>Version à souder :</b>  <b>A :</b> Raccord intermédiaire  <b>Exception en 451 07 :</b> sans possibilité de raccord arrière  <b>E :</b> Ecrou serre-fils  <b>Exception en 451 02 et 451 09 :</b> sans possibilité de raccord arrière  <b>A+PG :</b> Raccord PG (voir «particularité des raccords arrière» pour la description)  <b>AC :</b> Serre câble fourni sans serre-fils  <b>EC :</b> Serre câble fourni avec serre-fils  <b>J :</b> Raccord presse-étoupe - IP68  <b>T :</b> Raccord pour pièce moulée thermorétractable  <b>P :</b> Raccord pour potting  <b>G :</b> Raccord pour reprise de tresse  <b>EK(x)* :</b> Raccord presse-étoupe étanche à l'immersion  <b>KM(x)* :</b> Raccord presse-étoupe étanche au ruissellement et continuité de masse</p> <p><b>Version à sertir :</b>  <b>R :</b> Ecrou serre-fils  <b>Exception en 451 02 :</b> sans possibilité de raccord arrière  <b>R+PG :</b> Raccord PG (voir «particularité des raccords arrière» pour la description)  <b>RA :</b> Raccord intermédiaire  <b>RC :</b> Raccord serre-câble  <b>RT :</b> Raccord pour pièce moulée thermorétractable  <b>RP :</b> Raccord pour potting  <b>RG :</b> Raccord pour reprise de tresse  <b>SK(x)* :</b> Raccord presse-étoupe étanche à l'immersion</p> <p><b>Autres versions :</b>  <b>Y/YS/GS :</b> Version à piquer sur circuit imprimé (voir page 38)  <b>MW :</b> Version à wrapper (voir page 39)</p> <p><b>Taille de boîtier :</b> 8/10/12/14/16/18/20/22/24</p> <p><b>Arrangement de contact :</b> voir page 10 et 11</p> <p><b>Type de contact :</b>  <b>P :</b> Mâle  <b>S :</b> Femelle  <b>PS :</b> Pour traversée de cloison</p> <p><b>Codage / Orientation de l'isolant :</b>  Néant pour normal ou W, X, Y, Z (voir le système de codage page 9)</p> <p><b>Particularité des raccords arrière :</b>  <b>PG :</b> Raccord intermédiaire raccordé à un presse-étoupe PG plastique</p> <p><b>50 :</b> Suffixe obligatoire</p> <p><b>Traitement du boîtier :</b>  Néant pour le cadmié vert olive standard.  <b>01 :</b> Cadmié blanc  <b>02 :</b> Oxydation anodique noire - conforme ROHS  <b>70 :</b> Nickel chimique - conforme ROHS</p>										

\* : Remplacer «x» après EK, KM ou SK par le numéro de joint correspondant (se référer au bas de la page 34).

Cross references chart / *Tableau d'équivalence*

AMPHENOL PT designation	BNAE NF. L54125 451 designation	NFC 93422 HE301 designation	MIL-DTL-26482 Series I	VG 95328
PT00A xx-xx x*	45100A xx-xx x* 50	HE301B00A xx-xx x* 1A		
PT00A xx-xx x* SR	45100AC xx-xx x* 50	HE301B00AC xx-xx x* 1A		
PT00A xx-xx x* PG	45100A xx-xx x* PG 50			
PT00E xx-xx x*	45100E xx-xx x* 50	HE301B00E xx-xx x* 1A	MS3110E xx-xx x*	
PT00E xx-xx x* SR	45100EC xx-xx x* 50	HE301B00EC xx-xx x* 1A	MS3110F xx-xx x*	
PT00E xx-xx x* J	45100T xx-xx x* 50			
PT00P xx-xx x*	45100P xx-xx x* 50	HE301B00P xx-xx x* 1A	MS3110P xx-xx x*	
PT00W xx-xx x*	45100J xx-xx x* 50	HE301B00J xx-xx x* 1A		
PT00SE xx-xx x*	45100R xx-xx x* 50	HE301B00R xx-xx x* 1A	MS3120E xx-xx x*	VG 95328A xx-xx x*
PT00SE xx-xx x* SR	45100RC xx-xx x* 50	HE301B00RC xx-xx x* 1A	MS3120F xx-xx x*	VG 95328B xx-xx x*
PT00SE xx-xx x* J	45100RT xx-xx x* 50			
PT00SP xx-xx x*	45100RP xx-xx x* 50	HE301B00RP xx-xx x* 1A	MS3120P xx-xx x*	
PT00SE xx-xx x* SQ	45100RG xx-xx x* 50			VG 95328R xx-xx x*
PT01A xx-xx x*	45101A xx-xx x* 50	HE301B01A xx-xx x* 1A		
PT01A xx-xx x* SR	45101AC xx-xx x* 50	HE301B01AC xx-xx x* 1A		
PT01A xx-xx x* PG	45101A xx-xx x* PG50			
PT01E xx-xx x*	45101E xx-xx x* 50	HE301B01E xx-xx x* 1A	MS3111E xx-xx x*	
PT01E xx-xx x* SR	45101EC xx-xx x* 50	HE301B01EC xx-xx x* 1A	MS3111F xx-xx x*	
PT01E xx-xx x* J	45101T xx-xx x* 50			
PT01EK (x) xx-xx x*	45101EK (x) xx-xx x* 50			
PT01KM (x) xx-xx x*	45101KM (x) xx-xx x* 50			
PT01P xx-xx x*	45101P xx-xx x* 50	HE301B01P xx-xx x* 1A	MS3111P xx-xx x*	
PT01W xx-xx x*	45101J xx-xx x* 50	HE301B01J xx-xx x* 1A		
PT01SE xx-xx x*	45101R xx-xx x* 50	HE301B01R xx-xx x* 1A	MS3121E xx-xx x*	
PT01SE xx-xx x* SR	45101RC xx-xx x* 50	HE301B01RC xx-xx x* 1A	MS3121F xx-xx x*	
PT01SE xx-xx x* J	45101RT xx-xx x* 50			
PT01SK (x) xx-xx x*	45101SK (x) xx-xx x* 50			
PT01SP xx-xx x*	45101RP xx-xx x* 50	HE301B01RP xx-xx x* 1A	MS3121P xx-xx x*	
PTIH xx-xx x*				
PT02A xx-xx x*	45102Exx-xx x* 50	HE301B02Exx-xx x* 1A	MS3112E xx-xx x*	VG 95328H xx-xx x*
PT02C xx-xx x*				
PT02E xx-xx x*	45102Exx-xx x* 50	HE301B02Exx-xx x* 1A	MS3112E xx-xx x*	VG 95328H xx-xx x*
PT02SE xx-xx x*	45102Rxx-xx x* 50	HE301B02R xx-xx x* 1A	MS3122E xx-xx x*	VG 95328C xx-xx x*
PT02H xx-xx x*				
PT02MW xx-xx x*	45102MW xx-xx x* 50			
PT02Y xx-xx x*	45102Y xx-xx x* 50			
PT02YS xx-xx x*	45102YS xx-xx x* 50			
PT02GS xx-xx x*	45102GS xx-xx x* 50			

AMPHENOL PT designation	BNAE NF. L54125 451 designation	NFC 93422 HE301 designation	MIL-DTL-26482 Series I	VG 95328
PT06A xx-xx x*	45106A xx-xx x* 50	HE301B06A xx-xx x* 1A		
PT06A xx-xx x* SR	45106ACxx-xx x* 50	HE301B06AC xx-xx x* 1A		
PT06A xx-xx x* PG	45106Axx-xx x* PG 50			
PT006E xx-xx x*	45106Exx-xx x* 50	HE301B06E xx-xx x* 1A	MS3116E xx-xx x*	
PT06E xx-xx x* SR	45106ECxx-xx x* 50	HE301B06EC xx-xx x* 1A	MS3116F xx-xx x*	
PT06E xx-xx x* J	45106Txx-xx x* 50			
PT06EK (x) xx-xx x*	45106EK(x)xx-xx x* 50			
PT06KM (x) xx-xx x*	45106KM(x)xx-xx x* 50			
PT06G xx-xx x*				
PT06P xx-xx x*	45106P xx-xx x* 50	HE301B06P xx-xx x* 1A	MS3116P xx-xx x*	
PT06W xx-xx x*	45106J xx-xx x* 50	HE301B06J xx-xx x* 1A		
PT06SE xx-xx x*	45106R xx-xx x* 50	HE301B06R xx-xx x* 1A	MS3126E xx-xx x*	
PT06SE xx-xx x* SR	45106RC xx-xx x* 50	HE301B06RC xx-xx x* 1A	MS3126F xx-xx x*	VG 95328K xx-xx x*
PT06SE xx-xx x* J	45106RT xx-xx x* 50			VG 95328J xx-xx x*
PT06SK (x) xx-xx x*	45106SK xx-xx x* 50			
PT06SP xx-xx x*	45106RP xx-xx x* 50	HE301B06RP xx-xx x* 1A	MS3126P xx-xx x*	
PTG06SE xx-xx x* SQ	45136RG xx-xx x* 50			VG 95328M xx-xx x*
PT07A xx-xx x*	45107A xx-xx x* 50	HE301B07A xx-xx x* 1A		
PT07A xx-xx x* SR	45107AC xx-xx x* 50	HE301B07AC xx-xx x* 1A		
PT07C xx-xx x*				
PT07E xx-xx x*	45107E xx-xx x* 50	HE301B07E xx-xx x* 1A	MS3114E xx-xx x*	
PT07E xx-xx x* SR	45107EC xx-xx x* 50	HE301B07EC xx-xx x* 1A	MS3114F xx-xx x*	
PT07P xx-xx x*	45107P xx-xx x* 50	HE301B07P xx-xx x* 1A	MS3114P xx-xx x*	
PT07SE xx-xx x*	45107R xx-xx x* 50	HE301B07R xx-xx x* 1A	MS3124E xx-xx x*	VG 95328D xx-xx x*
PT07SE xx-xx x* SR	45107RC xx-xx x* 50	HE301B07RC xx-xx x* 1A	MS3124F xx-xx x*	VG 95328E xx-xx x*
PT07SP xx-xx x*	45107RP xx-xx x* 50	HE301B07RP xx-xx x* 1A	MS3124P xx-xx x*	
PT07SE xx-xx x* SQ	45107RG xx-xx x* 50			VG 95328T xx-xx x*
PT07H xx-xx x*				
PT07MW xx-xx x*	45107MW xx-xx x* 50			
PT07Y xx-xx x*	45107Y xx-xx x* 50			
PT07YS xx-xx x*	45107YS xx-xx x* 50			
PT07GS xx-xx x*	45107GS xx-xx x* 50			
PT08E xx-xx x* SR	45108EC xx-xx x* 50	HE301B08EC xx-xx x* 1A		
PT08P xx-xx x*	45108P xx-xx x* 50	HE301B08P xx-xx x* 1A		
PT08SE xx-xx x* SR	45108RC xx-xx x* 50	HE301B08RC xx-xx x* 1A		
PT09A xx-xx x*	45109E xx-xx x* 50			
PTB xx-xx x*				

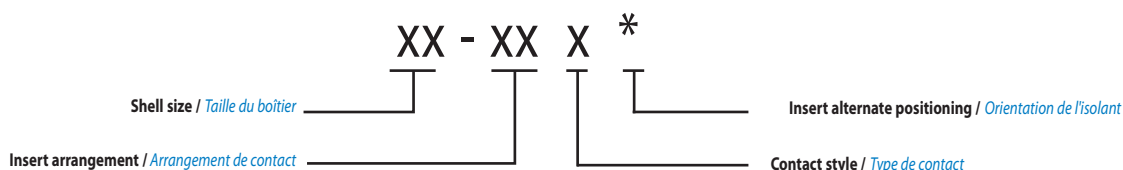



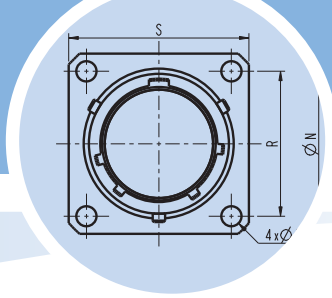

### Square flange receptacle 02 type

#### Embase carrée type 02

Solder / A souder	PT02A / PT02E / PT02C	45102E	VG95328H
Crimp / A sertir	PT02SE	45102R	VG95328C

Square flange receptacle without rear accessory possibility.  
Embase à collerette carrée sans possibilité de raccord.



Solder / A souder



Crimp / A sertir

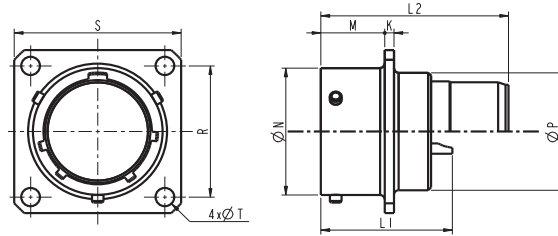

Shell size Taille du boîtier	K max.	L1 max. Solder / Souder	L2 max. Crimp / Sertir	M	Ø N	Ø P max.	R	S	Ø T ± 0.1
8	1.57	22.6	32.3	10.95	12.01	11.4	15.09	20.6	3.2
10	1.57	22.6	32.3	10.95	14.99	14.6	18.26	23.8	3.2
12	1.57	22.6	32.3	10.95	19.05	17.8	20.62	26.2	3.2
14	1.57	22.6	32.3	10.95	22.23	20.9	23.01	28.6	3.2
16	1.57	22.6	32.3	10.95	25.40	24.1	24.61	31.0	3.2
18	1.57	22.6	32.3	10.95	28.58	27.3	26.97	33.3	3.2
20	2.39	28.1	33.9	14.12	31.75	30.5	29.36	36.5	3.2
22	2.39	28.1	33.9	14.12	34.93	33.6	31.75	39.7	3.2
24	2.39	28.1	35.4	14.96	38.10	36.8	34.93	42.9	3.73

### Square flange receptacle 00 type

#### Embase carrée type 00

Solder / A souder	PT00A	45100A
Crimp / A sertir	-	45100RA

Square flange receptacle with intermediate backshell.  
Embase à collerette carrée avec raccord intermédiaire.



A type (solder)  
Type A (à souder)

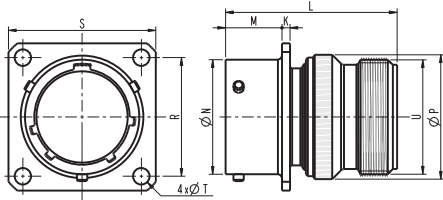

RA type (crimp)  
Type RA (à sertir)

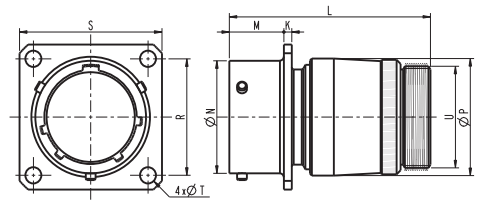

Shell size Taille du boîtier	K max.	L max.		M	Ø N	Ø P max.		R	S	Ø T ± 0.1	U Thread (class 2A) Filetage U (classe 2A)	
		A	RA			A	RA				A type (solder)	RA type (crimp)
8	1.57	34.3	41.5	10.95	12.01	14,7	13.9	15.09	20.6	3.2	0.5000-28UNEF	0.4375-28UNEF
10	1.57	34.3	41.5	10.95	14.99	17,9	17.1	18.26	23.8	3.2	0.6250-24UNEF	0.5625-24UNEF
12	1.57	34.3	41.5	10.95	19.05	20.9	20.3	20.62	26.2	3.2	0.7500-20UNEF	0.6875-24UNEF
14	1.57	34.3	41.5	10.95	22.23	24.3	23.3	23.01	28.6	3.2	0.8750-20UNEF	0.8125-20UNEF
16	1.57	34.3	41.5	10.95	25.40	27.3	26.5	24.61	31.0	3.2	1.0000-20UNEF	0.9375-20UNEF
18	1.57	34.3	41.5	10.95	28.58	30.6	29.5	26.97	33.3	3.2	1.1875-18UNEF	1.0625-18UNEF
20	2.39	40.7	45.0	14.12	31.75	33.5	32.7	29.36	36.5	3.2	1.1875-18UNEF	1.1875-18UNEF
22	2.39	40.7	45.0	14.12	34.93	36.8	36.0	31.75	39.7	3.2	1.4375-18UNEF	1.3125-18UNEF
24	2.39	42.3	46.5	14.96	38.10	40.0	39.2	34.93	42.9	3.73	1.4375-18UNEF	1.4375-18UNEF

To mount the receptacle on the panel, please refer to page 58 for panel drilling and thickness.

Pour le montage des embases sur panneau, se référer à la page 58 pour le perçage et l'épaisseur des panneaux.

all dimensions are in mm

Solder / A souder	PT00E	45100E	-
Crimp / A sertir	PT00SE	45100R	VG95328A



Square flange receptacle with grommet backnut.  
Embase à collerette carrée avec écrou serre-fils.

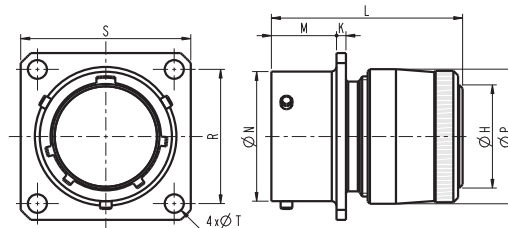

Shell size Taille du boîtier	Ø H	K max.	L max.	M	Ø N	Ø P max.	R	S	Ø T ± 0.1
8	9.3	1.57	32.7	10.95	12.01	13.9	15.09	20.6	3.2
10	12.3	1.57	32.7	10.95	14.99	17.1	18.26	23.8	3.2
12	15.2	1.57	32.7	10.95	19.05	20.3	20.62	26.2	3.2
14	18.5	1.57	32.7	10.95	22.23	23.3	23.01	28.6	3.2
16	21.7	1.57	32.7	10.95	25.40	26.5	24.61	31.0	3.2
18	24.2	1.57	32.7	10.95	28.58	29.5	26.97	33.3	3.2
20	27.4	2.39	34.2	14.12	31.75	32.7	29.36	36.5	3.2
22	30.6	2.39	34.2	14.12	34.93	36.0	31.75	39.7	3.2
24	33.8	2.39	35.8	14.96	38.10	39.2	34.93	42.9	3.73

Solder / A souder	PT00A (SR) / PT00E (SR)	45100AC / 45100EC	-
Crimp / A sertir	PT00SE (SR)	45100RC	VG95328B



Square flange receptacle with cable clamp backshell.  
Embase à collerette carrée avec raccord serre-câble.

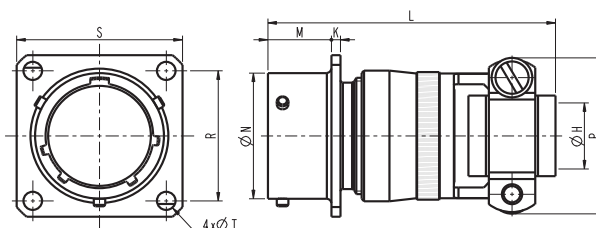

Shell size Taille du boîtier	ØH	K max.	L max.	M	ØN	P max.	R	S	ØT ± 0.1
8	3.2	1.57	49.0	10.95	12.01	19.3	15.09	20.6	3.2
10	4.8	1.57	49.0	10.95	14.99	20.8	18.26	23.8	3.2
12	7.9	1.57	49.0	10.95	19.05	24.0	20.62	26.2	3.2
14	9.5	1.57	49.0	10.95	22.23	27.2	23.01	28.6	3.2
16	12.7	1.57	52.4	10.95	25.40	28.8	24.61	31.0	3.2
18	15.9	1.57	52.4	10.95	28.58	35.1	26.97	33.3	3.2
20	15.9	2.39	54.8	14.12	31.75	35.1	29.36	36.5	3.2
22	19.1	2.39	54.8	14.12	34.93	39.9	31.75	39.7	3.2
24	20.3	2.39	56.4	14.96	38.10	42.3	34.93	42.9	3.73

Note: for the version without grommet A + SR (PT) or AC (451), use the nylon ring delivered with the cable clamp to screw your backshell at the rear of the receptacle.

Pour la version sans serre-fil A + SR (PT) ou AC (451), utiliser la bague en nylon livrée avec le serre-câble pour visser votre raccord à l'arrière de l'embase.

To mount the receptacle on the panel, please refer to page 58 for panel drilling and thickness.

Pour le montage des embases sur panneau, se référer à la page 58 pour le perçage et l'épaisseur des panneaux.

all dimensions are in mm

Solder / A souder	PT00 W	45100J
Crimp / A sertir	-	-

Square flange receptacle with metal sealing gland backshell.  
*Embase à collerette carrée avec raccord presse-étoupe métallique.*

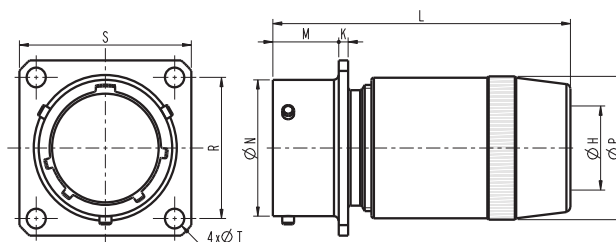

Shell size <i>Taille du boîtier</i>	Ø H		K max.	L max.	M	Ø N	Ø P max.	R	S	Ø T ± 0.1
	min.	max.								
8	4.3	5.8	1.57	40.8	10.95	12.01	13.6	15.09	20.6	3.2
10	5.2	7.9	1.57	41.8	10.95	14.99	16.8	18.26	23.8	3.2
12	8.6	11.2	1.57	45.4	10.95	19.05	20.3	20.62	26.2	3.2
14	10.6	13.7	1.57	50.3	10.95	22.23	23.6	23.01	28.6	3.2
16	14.0	15.6	1.57	55.8	10.95	25.40	26.8	24.61	31.0	3.2
18	15.2	17.1	1.57	61.6	10.95	28.58	30.0	26.97	33.3	3.2
20	16.1	19.0	2.39	72.7	14.12	31.75	33.3	29.36	36.5	3.2
22	17.0	21.5	2.39	76.8	14.12	34.93	36.5	31.75	39.7	3.2
24	18.8	22.7	2.39	82.5	14.96	38.10	39.7	34.93	42.9	3.73

Solder / A souder	PT00E (J)	45100T
Crimp / A sertir	PT00SE (J)	45100RT

Square flange receptacle with backnut for heatshrink moulded piece.  
*Embase à collerette carrée avec raccord pour pièce moulée thermorétractable.*

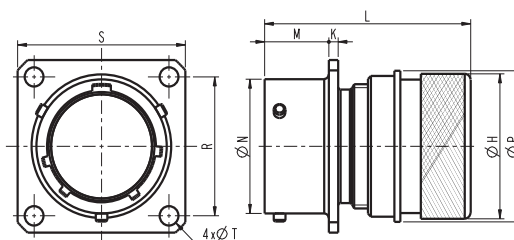

Shell size <i>Taille du boîtier</i>	Ø H	K max.	L max.	M	Ø N	Ø P max.	R	S	Ø T ± 0.1
8	15.6	1.57	35.0	10.95	12.01	15.4	15.09	20.6	3.2
10	18.4	1.57	35.0	10.95	14.99	18.6	18.26	23.8	3.2
12	23.7	1.57	35.0	10.95	19.05	21.8	20.62	26.2	3.2
14	24.5	1.57	35.0	10.95	22.23	25.0	23.01	28.6	3.2
16	29.8	1.57	37.5	10.95	25.40	28.2	24.61	31.0	3.2
18	32.0	1.57	37.5	10.95	28.58	31.3	26.97	33.3	3.2
20	36.1	2.39	47.5	14.12	31.75	34.5	29.36	36.5	3.2
22	38.5	2.39	47.5	14.12	34.93	37.7	31.75	39.7	3.2
24	41.5	2.39	47.5	14.96	38.10	40.9	34.93	42.9	3.73

To mount the receptacle on the panel, please refer to page 58 for panel drilling and thickness.

*Pour le montage des embases sur panneau, se référer à la page 58 pour le perçage et l'épaisseur des panneaux.*

all dimensions are in mm

Solder / A souder	PT00P	45100P
Crimp / A sertir	PT00SP	45100RP

Square flange receptacle with straight backshell for potting.  
*Embase à collerette carrée avec raccord pour potting.*

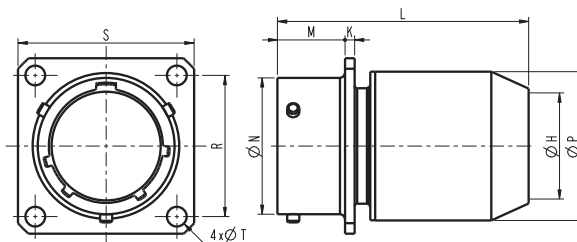

Shell size <i>Taille du boîtier</i>	Ø H	K max.	L max.		M	Ø N	Ø P max.	R	S	Ø T ± 0.1
			Solder	Crimp						
8	8.3	1.57	32	44	10.95	12.01	14.9	15.09	20.6	3.2
10	11.3	1.57	32	44	10.95	14.99	18.1	18.26	23.8	3.2
12	14.2	1.57	32	44	10.95	19.05	21.3	20.62	26.2	3.2
14	17.3	1.57	32	44	10.95	22.23	24.5	23.01	28.6	3.2
16	20.5	1.57	32	44	10.95	25.40	27.7	24.61	31.0	3.2
18	23.1	1.57	32	44	10.95	28.58	30.8	26.97	33.3	3.2
20	26.3	2.39	36	48	14.12	31.75	34.0	29.36	36.5	3.2
22	29.4	2.39	36	48	14.12	34.93	37.2	31.75	39.7	3.2
24	32.6	2.39	37	49	14.96	38.10	40.3	34.93	42.9	3.73

Solder / A souder	PT00E (SQ)	45100G	-
Crimp / A sertir	PT00SE (SQ)	45100RG	VG95328R

Square flange receptacle with SQ braid clamping backshell  
*Embase à collerette carrée avec raccord SQ pour reprise de tresse*

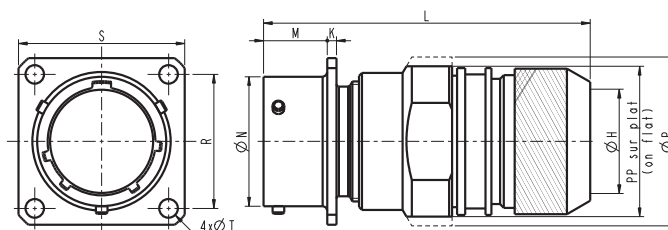

Shell size <i>Taille du boîtier</i>	Ø H	K	L max.	M	Ø N	Ø P	PP	R	S	Ø T ± 0.1
8	6.7	1.57	53	10.95	12.01	20	16.8	15.09	20.6	3.2
10	9.2	1.57	53	10.95	14.99	24	20.8	18.26	23.8	3.2
12	12.2	1.57	54	10.95	19.05	26	22.8	20.62	26.2	3.2
14	15.2	1.57	54	10.95	22.23	29	25.8	23.01	28.6	3.2
16	18.3	1.57	54	10.95	25.40	32	28.8	24.61	31.0	3.2
18	20.0	1.57	54	10.95	28.58	35	31.8	26.97	33.3	3.2
20	23.0	2.39	58	14.12	31.75	38	35.8	29.36	36.5	3.2
22	26.0	2.39	58	14.12	34.93	42	38.8	31.75	39.7	3.2
24	28.8	2.39	60	14.96	38.10	45	41.8	34.93	42.9	3.73

SQ backshell description: see page 35  
*Description du raccord SQ : Voir page 35*

To mount the receptacle on the panel, please refer to page 58 for panel drilling and thickness.  
*Pour le montage des embases sur panneau, se référer à la page 58 pour le perçage et l'épaisseur des panneaux.*

all dimensions are in mm

## Inline receptacle 01 type

### Prolongateur type 01

Solder / A souder	PT01A	45101A
Crimp / A sertir	-	45101RA

Inline receptacle with intermediate backshell.  
Prolongateur avec raccord intermédiaire.

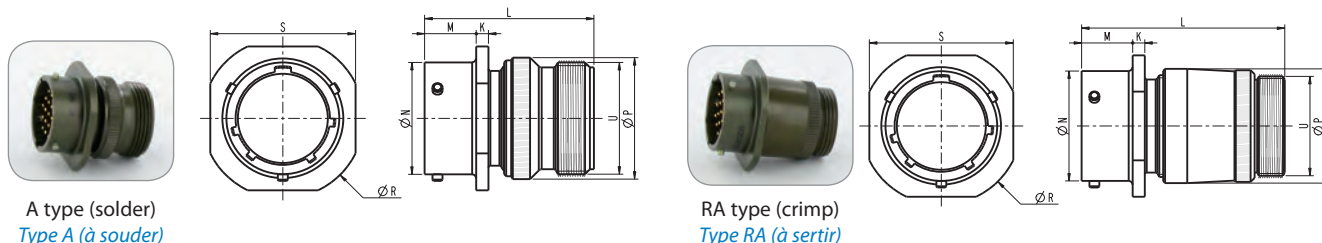

Shell size Taille du boîtier	K	L max		M	Ø N	Ø P		Ø R	S	U Thread (class 2A) Filetage U (classe 2A)	
		A	RA			A	RA			A type (solder)	RA type (crimp)
8	2.4	34.3	41.5	10.16	12.01	14,7	13.9	23.8	20.6	0.5000-28UNEF	0.4375-28UNEF
10	2.4	34.3	41.5	10.16	14.99	17,9	17.1	27.0	23.8	0.6250-24UNEF	0.5625-24UNEF
12	2.4	34.3	41.5	10.16	19.05	20,9	20.3	29.4	26.2	0.7500-20UNEF	0.6875-24UNEF
14	2.4	34.3	41.5	10.16	22.23	24,3	23.3	31.8	28.6	0.8750-20UNEF	0.8125-20UNEF
16	2.4	34.3	41.5	10.16	25.40	27,3	26.5	34.1	31.0	1.0000-20UNEF	0.9375-20UNEF
18	2.4	34.3	41.5	10.16	28.58	30,6	29.5	36.5	33.3	1.1875-18UNEF	1.0625-18UNEF
20	2.9	40.7	45.0	13.59	31.75	33,5	32.7	39.7	36.5	1.1875-18UNEF	1.1875-18UNEF
22	2.9	40.7	45.0	13.59	34.93	36,8	36.0	42.9	39.7	1.4375-18UNEF	1.3125-18UNEF
24	2.9	42.3	46.5	14.43	38.10	40,0	39.2	46.0	42.9	1.4375-18UNEF	1.4375-18UNEF

Solder / A souder	PT01E	45101E
Crimp / A sertir	PT01SE	45101R

Inline receptacle with grommet backnut.  
Prolongateur avec écrou serre-fils.

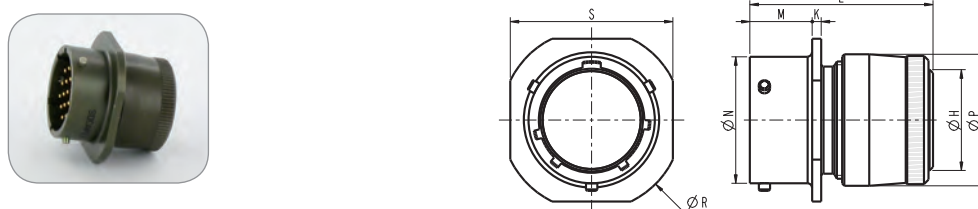

Shell size Taille du boîtier	Ø H	K	L max.	M	Ø N	Ø P max.	Ø R	S
8	9.3	2.4	32.7	10.16	12.01	13.9	23.8	20.6
10	12.3	2.4	32.7	10.16	14.99	17.1	27.0	23.8
12	15.2	2.4	32.7	10.16	19.05	20.3	29.4	26.2
14	18.5	2.4	32.7	10.16	22.23	23.3	31.8	28.6
16	21.7	2.4	32.7	10.16	25.40	26.5	34.1	31.0
18	24.2	2.4	32.7	10.16	28.58	29.5	36.5	33.3
20	27.4	2.9	34.2	13.59	31.75	32.7	39.7	36.5
22	30.6	2.9	34.2	13.59	34.93	36.0	42.9	39.7
24	33.8	2.9	35.8	14.43	38.10	39.2	46.0	42.9

all dimensions are in mm



Solder / A souder	PT01A (SR) / PT01E (SR)	45101AC / 45101EC
Crimp / A sertir	PT01SE (SR)	45101RC

Inline receptacle with cable clamp backshell.  
Prolongateur avec raccord serre-câble.

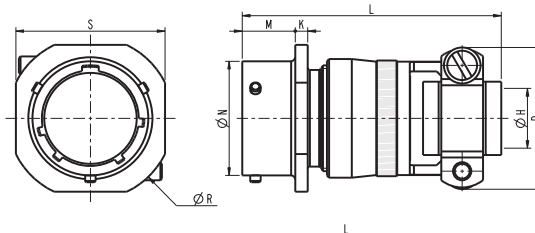

Shell size Taille du boîtier	Ø H	K	L max.	M	Ø N	P max.	Ø R	S
8	3.2	2.4	49.0	10.16	12.01	19.3	23.8	20.6
10	4.8	2.4	49.0	10.16	14.99	20.8	27.0	23.8
12	7.9	2.4	49.0	10.16	19.05	24.0	29.4	26.2
14	9.5	2.4	49.0	10.16	22.23	27.2	31.8	28.6
16	12.7	2.4	52.4	10.16	25.40	28.8	34.1	31.0
18	15.9	2.4	52.4	10.16	28.58	35.1	36.5	33.3
20	15.9	2.9	54.8	13.59	31.75	35.1	39.7	36.5
22	19.1	2.9	54.8	13.59	34.93	39.9	42.9	39.7
24	20.3	2.9	56.4	14.43	38.10	42.3	46.0	42.9

Note: for the version without grommet A + SR (PT) or AC (451), use the nylon ring delivered with the cable clamp to screw your backshell at the rear of the receptacle.

Pour la version sans serre-fil A + SR (PT) ou AC (451), utiliser la bague en nylon livrée avec le serre-câble pour visser votre raccord à l'arrière de l'embase.

Solder / A souder	PT01W	45101J
Crimp / A sertir	-	-

Inline receptacle with metal sealing gland backshell.  
Prolongateur avec raccord presse-étoupe métallique.

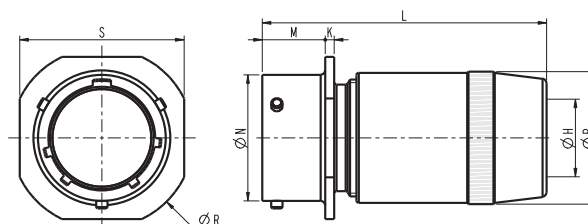

Shell size Taille du boîtier	Ø H		K	L max.	M	Ø N	Ø P max.	Ø R	S
	min.	max.							
8	4.3	5.8	2.4	40.8	10.16	12.01	13.6	23.8	20.6
10	5.2	7.9	2.4	41.8	10.16	14.99	16.8	27.0	23.8
12	8.6	11.2	2.4	45.4	10.16	19.05	20.3	29.4	26.2
14	10.6	13.7	2.4	50.3	10.16	22.23	23.6	31.8	28.6
16	14.0	15.6	2.4	55.8	10.16	25.40	26.8	34.1	31.0
18	15.2	17.1	2.4	61.6	10.16	28.58	30.0	36.5	33.3
20	16.1	19.0	2.9	72.7	13.59	31.75	33.3	39.7	36.5
22	17.0	21.5	2.9	76.8	13.59	34.93	36.5	42.9	39.7
24	18.8	22.7	2.9	82.5	14.43	38.10	39.7	46.0	42.9

all dimensions are in mm

Solder / A souder	PT01A (PG)	45101A (PG)
Crimp / A sertir	PT01SE (PG)	45101R (PG)

Inline receptacle with straight adaptor terminated by a PG type plastic sealing gland.

*Prolongateur avec raccord intermédiaire raccordé à un presse-étoupe plastique type PG.*

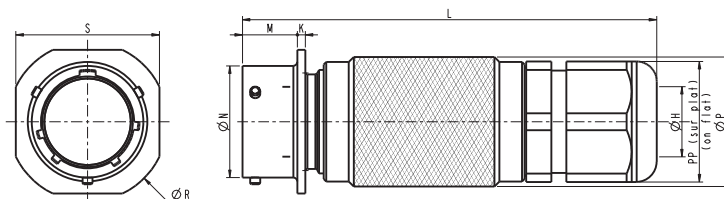

Shell size <i>Taille du boîtier</i>	Ø H min-max	K	L max.	M	Ø N	Ø P max.	PG	PP	Ø R	S
8	2.5 - 6.5	2.4	75.5	10.16	12.01	16.6	PG7	15	23.8	20.6
10	3.5 - 8	2.4	79.5	10.16	14.99	19.5	PG9	19	27.0	23.8
12	4 - 10	2.4	81.5	10.16	19.05	22.8	PG11	22	29.4	26.2
14	5 - 12	2.4	88.5	10.16	22.23	25.8	PG13.5	24	31.8	28.6
16	9 - 14	2.4	90.5	10.16	25.40	28.9	PG16	27	34.1	31.0
18	9 - 14	2.4	95.5	10.16	28.58	32.0	PG16	27	36.5	33.3
20	9 - 14	2.9	101	13.59	31.75	35.2	PG16	27	39.7	36.5
22	13 - 18	2.9	110	13.59	34.93	38.3	PG21	33	42.9	39.7
24	13 - 18	2.9	111.5	14.43	38.10	41.6	PG21	33	46.0	42.9

Solder / A souder	PT01E (J)	45101T
Crimp / A sertir	PT01SE (J)	45101RT

Inline receptacle with backnut for heatshrink moulded piece.

*Prolongateur avec raccord pour pièce moulée thermorétractable.*

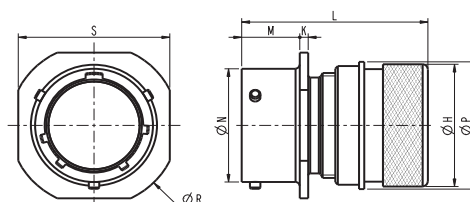

Shell size <i>Taille du boîtier</i>	Ø H max.	K	Lmax.	M	Ø N	Ø P max.	Ø R	S
8	15.6	2.4	35.0	10.16	12.01	15.4	23.8	20.6
10	18.4	2.4	35.0	10.16	14.99	18.6	27.0	23.8
12	23.7	2.4	35.0	10.16	19.05	21.8	29.4	26.2
14	24.5	2.4	35.0	10.16	22.23	25.0	31.8	28.6
16	29.8	2.4	37.5	10.16	25.40	28.2	34.1	31.0
18	32.0	2.4	37.5	10.16	28.58	31.3	36.5	33.3
20	36.1	2.9	47.5	13.59	31.75	34.5	39.7	36.5
22	38.5	2.9	47.5	13.59	34.93	37.7	42.9	39.7
24	41.5	2.9	47.5	14.43	38.10	40.9	46.0	42.9

all dimensions are in mm

Solder / A souder	PT01P	45101P
Crimp / A sertir	PT01SP	45101RP

Inline receptacle with straight backshell for potting.  
Prolongateur avec raccord pour potting.

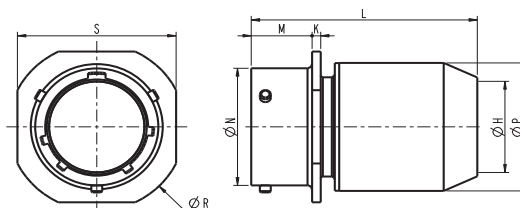

Shell size Taille du boîtier	Ø H	K	L max.		M	Ø N	Ø P max.	Ø R	S
			Solder	Crimp					
8	8.3	2.4	32	44	10.16	12.01	14.9	23.8	20.6
10	11.3	2.4	32	44	10.16	14.99	18.1	27.0	23.8
12	14.2	2.4	32	44	10.16	19.05	21.3	29.4	26.2
14	17.3	2.4	32	44	10.16	22.23	24.5	31.8	28.6
16	20.5	2.4	32	44	10.16	25.40	27.7	34.1	31.0
18	23.1	2.4	32	44	10.16	28.58	30.8	36.5	33.3
20	26.3	2.9	36	48	13.59	31.75	34.0	39.7	36.5
22	29.4	2.9	36	48	13.59	34.93	37.2	42.9	39.7
24	32.6	2.9	37	49	14.43	38.10	40.3	46.0	42.9

Solder / A souder	PT01EK / PT01KM	45101EK / 45101KM
Crimp / A sertir	PT01SK	45101SK

Inline receptacle with rain proof or immersion proof sealing gland backshell with strong grip.  
Prolongateur avec raccord presse-étoupe étanche au ruissellement ou à l'immersion.

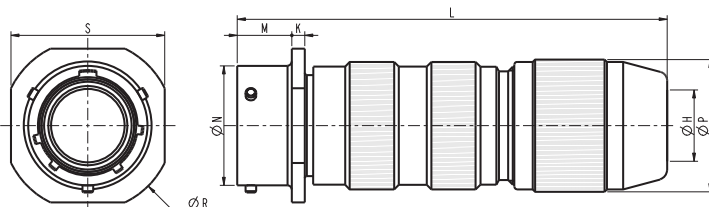

Shell size Taille du boîtier	K	L max.		M	Ø N	Ø P max.	Ø R	S
		EK type	KM/SK type					
8	2.4	71.5	81.5	10.16	12.01	17.0	23.8	20.6
10	2.4	71.5	81.5	10.16	14.99	19.0	27.0	23.8
12	2.4	71.5	81.5	10.16	19.05	25.0	29.4	26.2
14	2.4	79.5	94.5	10.16	22.23	27.0	31.8	28.6
16	2.4	79.5	94.5	10.16	25.40	28.5	34.1	31.0
18	2.4	79.5	94.5	10.16	28.58	31.5	36.5	33.3
20	2.9	91.5	107	13.59	31.75	34.5	39.7	36.5
22	2.9	94	109.5	13.59	34.93	34.5	42.9	39.7
24	2.9	95	110	14.43	38.10	36.0	46.0	42.9

Please refer to end of page 34 for dimension H depending on the gasket number.  
Veuillez vous référer au bas de la page 34 pour la dimension H selon le numéro de joint utilisé.

Solder / A souder	PT01E (SQ)	45101G
Crimp / A sertir	PT01SE (SQ)	45101RG

Inline receptacle with SQ braid clamping backshell.  
Prolongateur avec raccord SQ pour reprise de tresse.

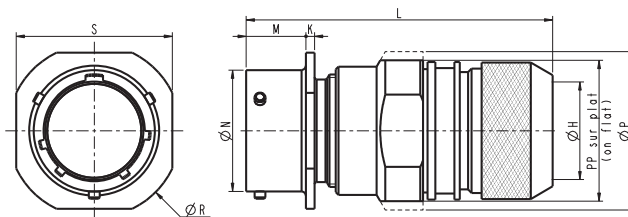

Shell size Taille du boîtier	Ø H	K	L max.	M	Ø N	Ø P	PP	Ø R	S
8	6.7	2.4	53	10.16	12.01	20	16.8	23.8	20.6
10	9.2	2.4	53	10.16	14.99	24	20.8	27.0	23.8
12	12.2	2.4	54	10.16	19.05	26	22.8	29.4	26.2
14	15.2	2.4	54	10.16	22.23	29	25.8	31.8	28.6
16	18.3	2.4	54	10.16	25.40	32	28.8	34.1	31.0
18	20.0	2.4	54	10.16	28.58	35	31.8	36.5	33.3
20	23.0	2.9	58	13.59	31.75	38	35.8	39.7	36.5
22	26.0	2.9	58	13.59	34.93	42	38.8	42.9	39.7
24	28.8	2.9	60	14.43	38.10	45	41.8	46.0	42.9

SQ backshell description: see page 35  
Description du raccord SQ : Voir page 35

## Jam nut receptacle 07 type Embase à écrou type 07

Solder / A souder	PT07A / PT07C	45107A
Crimp / A sertir	-	-

Jam nut receptacle.  
Embase à fixation par écrou.

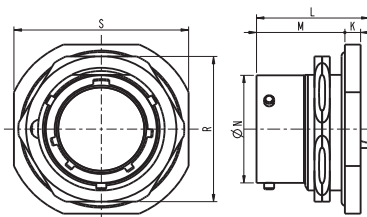

Shell size Taille du boîtier	K	L max.	M	Ø N	R	S
8	3.2	23.0	17.7	12.01	19	23.8
10	3.2	23.0	17.7	14.99	22	27.0
12	3.2	23.0	17.7	19.05	27	31.8
14	3.2	23.0	17.7	22.23	30	34.9
16	3.2	23.0	17.7	25.40	33	38.1
18	3.2	23.0	17.7	28.58	37	41.3
20	4.0	29.0	22.5	31.75	40	46.0
22	4.0	29.0	22.5	34.93	43	49.2
24	4.0	29.0	23.3	38.10	46	52.4

To mount the receptacle on the panel, please refer to page 58 for panel drilling and thickness.  
Pour le montage des embases sur panneau, se référer à la page 58 pour le perçage et l'épaisseur des panneaux.

all dimensions are in mm

Solder / A souder	PT07E	45107E	-
Crimp / A sertir	PT07SE	45107R	VG95328D

Jam nut receptacle with grommet backnut.  
Embase à fixation par écrou avec écrou serre-fils.

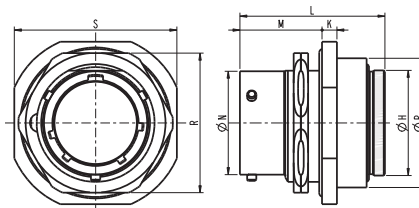

Shell size Taille du boîtier	Ø H	K	L max.	M	Ø N	Ø P max.	R	S
8	16.4	3.2	35.0	17.7	12.01	18.5	19	23.8
10	19.6	3.2	35.0	17.7	14.99	21.6	22	27.0
12	22.6	3.2	35.0	17.7	19.05	24.8	27	31.8
14	25.8	3.2	35.0	17.7	22.23	28.0	30	34.9
16	28.8	3.2	35.0	17.7	25.40	31.2	33	38.1
18	32.0	3.2	35.0	17.7	28.58	34.3	37	41.3
20	38.2	4.0	41.2	22.5	31.75	38.3	40	46.0
22	41.4	4.0	41.2	22.5	34.93	41.5	43	49.2
24	44.4	4.0	42.8	23.3	38.10	44.7	46	52.4

Solder / A souder	PT07E (SR)	45107EC	-
Crimp / A sertir	PT07SE (SR)	45107RC	VG95328E

Jam nut receptacle with cable clamp backshell.  
Embase à fixation par écrou avec raccord serre-câble.

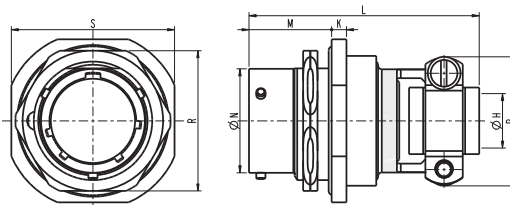

Shell size Taille du boîtier	Ø H	K	L max.	M	Ø N	P max.	R	S
8	3.2	3.2	49.5	17.7	12.01	19.3	19	23.8
10	4.8	3.2	49.5	17.7	14.99	20.8	22	27.0
12	7.9	3.2	50.0	17.7	19.05	24.0	27	31.8
14	9.5	3.2	50.0	17.7	22.23	27.2	30	34.9
16	12.7	3.2	52.6	17.7	25.40	28.8	33	38.1
18	15.9	3.2	52.6	17.7	28.58	35.1	37	41.3
20	15.9	4.0	56.5	22.5	31.75	35.1	40	46.0
22	19.1	4.0	56.5	22.5	34.93	39.9	43	49.2
24	20.3	4.0	58.2	23.3	38.10	42.3	46	52.5

To mount the receptacle on the panel, please refer to page 58 for panel drilling and thickness.

Pour le montage des embases sur panneau, se référer à la page 58 pour le perçage et l'épaisseur des panneaux.

all dimensions are in mm

information & contact : [www.451-connectors.com](http://www.451-connectors.com)

Solder / A souder	PT07P	45107P
Crimp / A sertir	PT07SP	45107RP

Jam nut receptacle with straight backshell for potting.

Embase à fixation par écrou avec raccord pour potting.

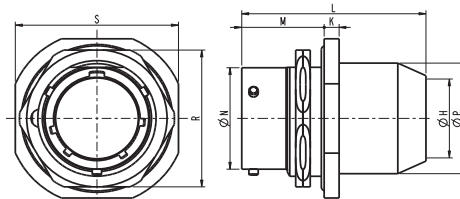

Shell size Taille du boîtier	Ø H	K	L max.		M	Ø N	Ø P max.	R	S
			Solder	Crimp					
8	8.3	3.2	34.5	39.9	17.7	12.01	14.9	19	25.8
10	11.3	3.2	34.5	39.9	17.7	14.99	18.1	22	27.0
12	14.2	3.2	34.5	39.9	17.7	19.05	21.3	27	31.8
14	17.3	3.2	34.5	39.9	17.7	22.23	24.5	30	34.9
16	20.5	3.2	34.5	39.9	17.7	25.40	27.7	33	38.1
18	23.1	3.2	34.5	39.9	17.7	28.58	30.8	37	41.3
20	26.3	4.0	42.0	47.1	22.5	31.75	34.0	40	46.0
22	29.4	4.0	42.0	47.1	22.5	34.93	37.2	43	49.2
24	32.6	4.0	42.7	47.9	23.3	38.10	40.3	46	52.4

Solder / A souder	-	-
Crimp / A sertir	PT07SE (SQ)	45107RG

Jam nut receptacle with SQ braid clamping backshell.

Embase à fixation par écrou avec raccord SQ pour reprise de tresse.

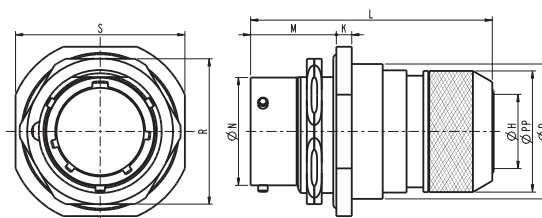

Shell size Taille du boîtier	Ø H	K	L max.	M	Ø N	Ø P max.	Ø PP	R	S
8	6.7	3.2	49.6	17.7	12.01	18.5	16	19	25.8
10	9.2	3.2	49.6	17.7	14.99	21.6	18	22	27.0
12	12.2	3.2	50.6	17.7	19.05	24.8	22	27	31.8
14	15.2	3.2	50.6	17.7	22.23	28.0	25	30	34.9
16	18.3	3.2	50.6	17.7	25.40	31.2	28	33	38.1
18	20.0	3.2	50.6	17.7	28.58	34.3	32	37	41.3
20	23.0	4.0	55.8	22.5	31.75	38.3	34	40	46.0
22	26.0	4.0	55.8	22.5	34.93	41.5	38	43	49.2
24	28.8	4.0	57.5	23.3	38.10	44.7	41	46	52.4

To mount the receptacle on the panel, please refer to page 58 for panel drilling and thickness.

Pour le montage des embases sur panneau, se référer à la page 58 pour le perçage et l'épaisseur des panneaux.

all dimensions are in mm

## Plug 06 type

### Fiche type 06

Solder / A souder	PT06A	45106A
Crimp / A sertir	-	45106RA

Straight plug with intermediate backshell.  
Fiche droite avec raccord intermédiaire.

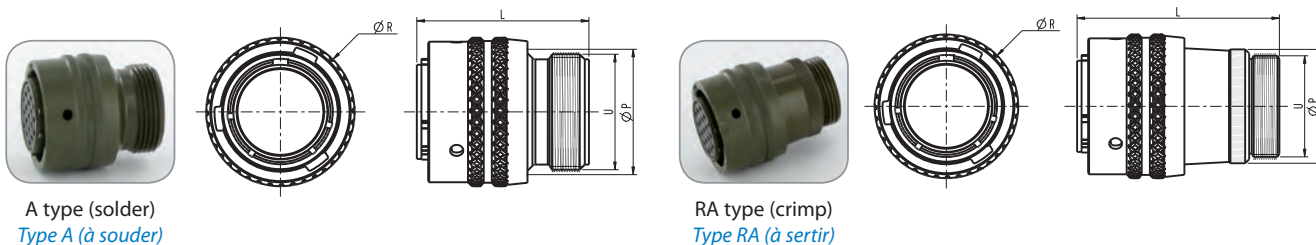

Shell size Taille du boîtier	L max.		Ø P		Ø R	U Thread (class 2A) Filetage U (classe 2A)	
	A	RA	A	RA		A type (solder)	RA type (crimp)
8	34.3	41.5	14,7	13.9	18.6	0.5000-28 UNEF	0.4375-28 UNEF
10	34.3	41.5	17,9	17.1	21.4	0.6250-24 UNEF	0.5625-24 UNEF
12	34.3	41.5	20,9	20.3	25.8	0.7500-20 UNEF	0.6875-24 UNEF
14	34.3	41.5	24,3	23.3	29.0	0.8750-20 UNEF	0.8125-20 UNEF
16	34.3	41.5	27,3	26.5	32.2	1.0000-20 UNEF	0.9375-20 UNEF
18	34.3	41.5	30,6	29.5	34.9	1.1875-18 UNEF	1.0625-18 UNEF
20	40.7	45.0	33,5	32.7	38.5	1.1875-18 UNEF	1.1875-18 UNEF
22	40.7	45.0	36,8	36.0	41.7	1.4375-18 UNEF	1.3125-18 UNEF
24	42.3	46.5	40,0	39.2	44.7	1.4375-18 UNEF	1.4375-18 UNEF

Solder / A souder	PT06E	45106E
Crimp / A sertir	PT06SE	45106R

Straight plug with grommet backnut.  
Fiche droite avec écrou serre-fils.

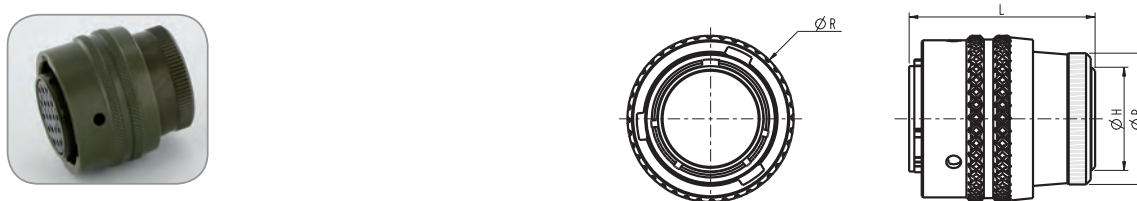

Shell size Taille du boîtier	Ø H	L max.	Ø P	Ø R
8	9.3	33.0	13.9	18.6
10	12.3	33.0	17.1	21.4
12	15.2	33.0	20.3	25.8
14	18.5	33.0	23.3	29.0
16	21.7	33.0	26.5	32.2
18	24.2	33.0	29.5	34.9
20	27.4	33.0	32.7	38.5
22	30.6	33.0	36.0	41.7
24	33.8	34.0	39.2	44.7

all dimensions are in mm

information & contact : [www.451-connectors.com](http://www.451-connectors.com)



Solder / A souder	PT06A (SR) / PT06E (SR)	45106AC / 45106EC	-
Crimp / A sertir	PT06SE (SR)	45106RC	VG95328K

Straight plug with cable clamp backshell.  
Fiche droite avec raccord serre-câble.

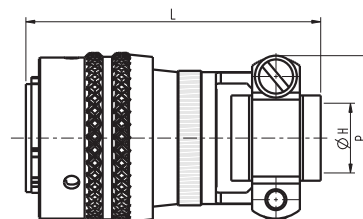
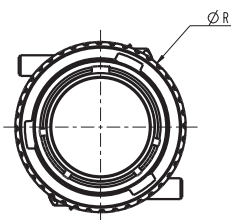

Shell size Taille du boîtier	Ø H	L max.	P max.	Ø R
8	3.2	49.0	19.3	18.6
10	4.8	49.0	20.8	21.4
12	7.9	49.0	24.0	25.8
14	9.5	49.0	27.2	29.0
16	12.7	52.4	28.8	32.2
18	15.9	52.4	35.1	34.9
20	15.9	54.8	35.1	38.5
22	19.1	54.8	39.9	41.7
24	20.3	56.4	42.3	44.7

Note: for the version without grommet A + SR (PT) or AC (451), use the nylon ring delivered with the cable clamp to screw your backshell at the rear of the plug.

Pour la version sans serre-fil A + SR (PT) ou AC (451), utiliser la bague en nylon livrée avec le serre-câble pour visser votre raccord à l'arrière de la fiche.

Solder / A souder	PT06W	45106J
Crimp / A sertir	-	-

Straight plug with metal sealing gland backshell.  
Fiche droite avec raccord presse-étoupe métallique.

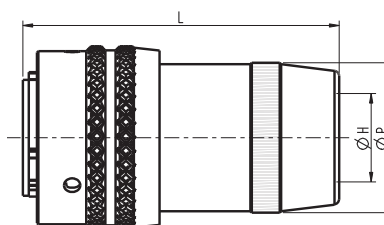
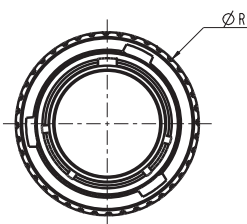

Shell size Taille du boîtier	Ø H		L max.	Ø P max.	Ø R
	min.	max.			
8	4.3	5.8	43.3	13.6	18.6
10	5.2	7.9	43.3	16.8	21.4
12	8.6	11.2	46.9	20.3	25.8
14	10.6	13.7	51.8	23.6	29.0
16	14.0	15.6	57.3	26.8	32.2
18	15.2	17.1	63.1	30.0	34.9
20	16.1	19.0	72.2	33.3	38.5
22	17.0	21.5	76.2	36.5	41.7
24	18.8	22.7	81.5	39.7	44.7

all dimensions are in mm

Solder / A souder	PT06A (PG)	45106A (PG)
Crimp / A sertir	PT06SE (PG)	45106R (PG)

Straight plug with adaptor terminated by a PG type plastic sealing gland.

Fiche droite avec raccord intermédiaire raccordé à un presse étoupe plastique type PG.

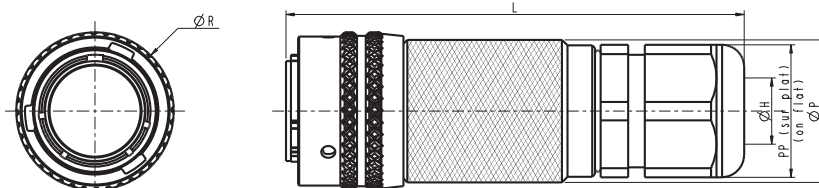

Shell size Taille du boîtier	Ø H		L max.	Ø P max.	PG size	PP	Ø R
	min	max					
8	2.5	6.5	51.2	16.6	PG 7	15	18.6
10	3.5	8	51.2	19.5	PG 9	19	21.4
12	4	10	51.2	22.8	PG 11	22	25.8
14	5	12	56.2	25.8	PG 13.5	24	29.0
16	9	14	56.2	28.9	PG 16	27	32.2
18	9	14	61.2	32.0	PG 16	27	34.9
20	9	14	65.2	35.2	PG 16	27	38.5
22	13	18	70.2	38.3	PG 21	33	41.7
24	13	18	70.2	41.6	PG 21	33	44.7

Solder / A souder	PT06E (J)	45106T	-
Crimp / A sertir	PT06SE (J)	45106RT	VG95328J

Straight plug with backnut for heatshrink moulded piece.

Fiche droite avec raccord pour pièce moulée thermorétractable.

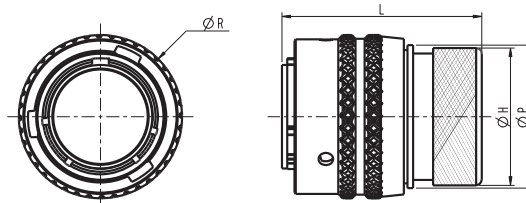

Shell size Taille du boîtier	Ø H	L max.	Ø P max.	Ø R
8	15.6	35.0	15.4	18.6
10	18.4	35.0	18.6	21.4
12	23.7	35.0	21.8	25.8
14	24.5	35.0	25.0	29.0
16	29.8	37.5	28.2	32.2
18	32.0	37.5	31.3	34.9
20	36.1	47.5	34.5	38.5
22	38.5	47.5	37.7	41.7
24	41.5	47.5	40.9	44.7

all dimensions are in mm

Solder / A souder	PT06P	45106P
Crimp / A sertir	PT06SP	45106RP

Straight plug with backshell for potting.

Fiche droite avec raccord pour potting.

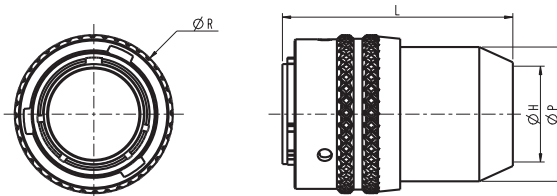

Shell size Taille du boîtier	Ø H	L max.		Ø P	Ø R
		Solder	Crimp		
8	8.3	35	44	14.9	18.6
10	11.3	35	44	18.1	21.4
12	14.2	35	44	21.3	25.8
14	17.3	35	44	24.5	29.0
16	20.5	35	44	27.7	32.2
18	23.1	35	44	30.8	34.9
20	26.3	39	48	34.0	38.5
22	29.4	39	48	37.2	41.7
24	32.6	40	49	40.3	44.7

Solder / A souder	PT06EK / PT06KM	45106EK / 45106KM
Crimp / A sertir	PT06SK	45106SK

Straight plug with rain proof or immersion proof sealing gland backshell.

Fiche droite avec raccord presse-étoupe étanche au ruissellement ou à l'immersion.

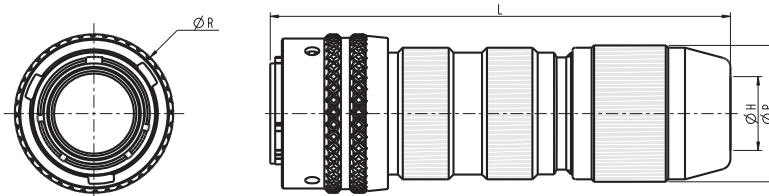

Shell size Taille du boîtier	L max.		Ø P	Ø R
	EK type	KM / SK type		
8	71.5	81.5	17.0	18.6
10	71.5	81.5	19.0	21.4
12	71.5	81.5	25.0	25.8
14	79.5	94.5	27.0	29.0
16	79.5	94.5	28.5	32.2
18	79.5	94.5	31.5	34.9
20	91.5	105.0	34.5	38.5
22	94.0	107.5	34.5	41.7
24	94.5	108.0	36.0	44.7

Shell size Taille du boîtier	Ø H Acceptable cable diameter / Diamètre de câble admissible		
	Gasket n° 1 / Joint n° 1	Gasket n° 2 / Joint n° 2	Gasket n° 3 / Joint n° 3
8	4.0 to 5.0	5.0 to 6.5	
10	5.0 to 6.5	6.5 to 8.0	
12	8.0 to 9.5	9.5 to 11.0	
14	10.5 to 12.0	12.0 to 13.5	7.0 to 9.5
16	12.5 to 14.0	14.0 to 15.6	
18	15.0 to 17.0	17.0 to 19.0	14 to 15.6
20	15.0 to 17.0	17.0 to 19.0	14 to 15.6
22	17.0 to 19.0	19.0 to 21.5	
24	18.5 to 20.5	20.5 to 23.0	

all dimensions are in mm

## Plug with grounding ring G06 / 36 type Fiche avec bague de blindage type G06 / 36

Solder / A souder	PTG06E (SQ)	45136G	-
Crimp / A sertir	PTG06SE (SQ)	45136RG	VG95328M

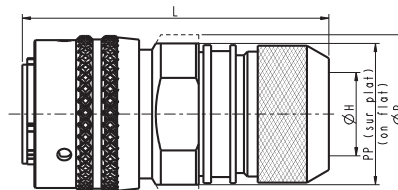
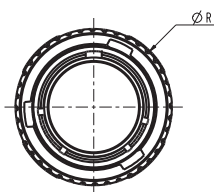

Straight plug with SQ braid clamping backshell.  
Fiche droite avec raccord SQ pour reprise de tresse.

Shell size <i>Taille du boîtier</i>	Ø H min.	L max.	Ø P	PP	Ø R
8	6.7	54	20	16.8	18.6
10	9.2	54	24	20.8	21.4
12	12.2	55	26	22.8	25.8
14	15.2	55	29	25.8	29.0
16	18.3	55	32	28.8	32.2
18	20.0	55	35	31.8	34.9
20	23.0	58	38	35.8	38.5
22	26.0	58	42	38.8	41.7
24	28.8	60	45	41.8	44.7

### SQ backshell (in accordance with VG95328 standard):

- Compatible with **solder and crimp** contact versions and with 00, 01, 07 & G06 shell types.
- High EMI-RFI protection level.
- Clamping braid backshell by screwing system.
- Sealed when equipped with straight or right angled heatshrink moulded pieces mentioned on page 57.
- User friendly, no tooling required.

Please consult us for cabling information.

### Raccord SQ (conforme à la norme VG95328) :

- Compatible avec les versions à souder et à sertir, et avec les types de boîtier 00, 01, 07 et G06.
- Excellent niveau de protection EMI.
- Raccord à reprise de tresse par un système de vissage.
- Étanche lorsqu'il est équipé d'une pièce moulée thermorétractable droite ou coudée, telle que mentionnée page 57.
- Facile à utiliser, aucun outil n'est nécessaire.

Veuillez nous consulter pour de plus amples renseignements sur le câblage.

Solder / A souder	PT06G	-
Crimp / A sertir	-	-



Plug with straight soldering braid backshell.

*Fiche avec raccord pour reprise de tresse avec terminaison étamée droite.*

Solder / A souder	PT08G	-
Crimp / A sertir	-	-



Plug with right angled soldering braid backshell.

*Fiche avec raccord pour reprise de tresse avec terminaison étamée coudée.*

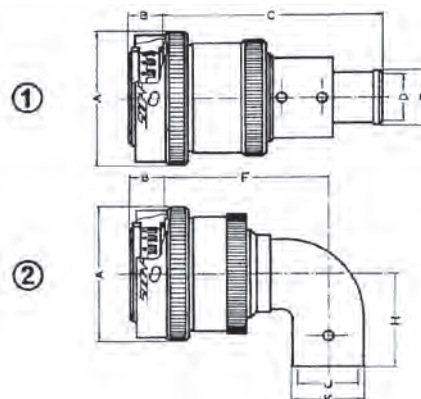

Shell size <i>Taille du boîtier</i>	Straight Plug PT06G / <i>Fiche droite PT06G</i>					Right Angle Plug PT08G / <i>Fiche coudée PT08G</i>					
	Ø A	B	C max.	Ø D*	E	Ø A	B	F max.	H	Ø J*	Ø K
8	18.6	9	37.2	9	12	-	-	-	-	-	-
10	21.4	9	42.0	6	7.5	21.4	9	35.0	17	10	12
12	25.8	9	44.8	12.4	13.8	25.8	9	33.0	17	10	12
14	29.0	9	44.8	14	15.8	29.0	9	34.5	19.5	12	14
16	32.2	9	48.5	15	17.5	32.2	9	36.9	22	14	16
18	34.9	9	54.5	12.4	13.8	34.9	9	41.0	24	16	18
20	38.5	10.5	63.0	17	20	38.5	10.5	46.5	26.5	18	20
22	41.7	10.5	63.0	19	22	41.7	10.5	48.0	32	20	22

\* D and J: diameter of the cable unjacketed and without braid.  
Please consult us for cabling information.

*\* D et J : diamètre du câble sans gaine et sans tresse.*

*Veuillez nous consulter pour de plus amples renseignements sur le câblage.*

#### PT06G / PT08G backshells = Amphenol Socapex design:

- Compatible with **solder contact** version and with 06 & 08 shell types.
- Outstanding EMI-RFI protection level.
- Soldering braid backshell (the rear soldering part of the backshell is tin plated to allow soldering of the braid).
- Available in straight or right angle version (low profile).
- Sealed when equipped with heatshrink sleeve mentioned on page 57.

#### Raccord PT06G / PT08G = conception Amphenol Socapex :

- Compatible avec des **contacts à souder**, et avec les types de boîtier 06 et 08.
- Excellent niveau de protection EMI.
- La partie arrière du raccord est étamée pour permettre la soudure de la tresse.
- Existe en version droite ou coudée (faible encombrement).
- Étanche lorsqu'il est équipé d'une pièce moulée thermorétractable telle que mentionnée page 57.

## Right angle plug 08 type

### Fiche coudée type 08

Solder / A souder	PT08E (SR)	45108EC
Crimp / A sertir	PT08SE (SR)	45108RC

Plug with 90° cable clamp backshell.  
Fiche avec raccord serre-câble coudé à 90°.

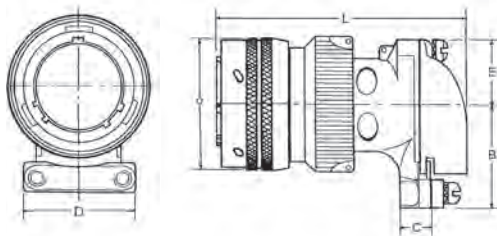

Shell size Taille du boîtier	B	C		D ±1.6	E	L max.	Q
		min	max				
8	16.6	4.3	6.6	23.9	8.6	53	18.6
10	19.0	4.3	9.8	30.2	10.0	55	21.4
12	20.6	6.7	9.6	30.2	11.4	58	25.8
14	23.0	7.8	13.8	31.8	13.2	61	29.0
16	26.2	8.4	16.2	33.4	14.8	65	32.2
18	25.8	11.2	17.4	39.7	15.8	69	34.9
20	27.4	12.9	19.6	41.3	17.3	71	38.5
22	28.9	13.0	21.8	43.6	18.8	72	41.7
24	32.1	16.7	23.4	44.5	20.2	78	44.7

Solder / A souder	PT08P	45108P
Crimp / A sertir	-	-

Plug with 75° angled backshell for potting.  
Fiche avec raccord pour potting coudé à 75°.

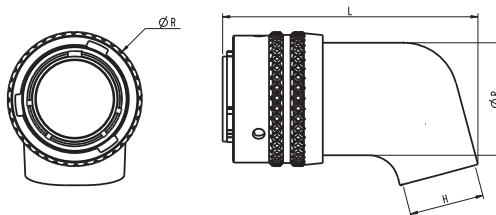
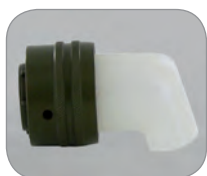

Shell size Taille du boîtier	H	L max.	Ø P max.	Ø R
8	7.9 x 11.1	42.5	14.8	18.6
10	11.1 x 14.3	46.0	18.0	21.4
12	13.1 x 17.5	48.5	21.2	25.8
14	15.9 x 19.8	50.0	24.4	29.0
16	16.7 x 22.6	51.5	27.6	32.2
18	17.9 x 25.4	52.5	30.7	34.9
20	19.5 x 28.6	59.5	33.9	38.5
22	20.6 x 31.3	60.5	37.1	41.7
24	23.3 x 34.9	69.0	40.2	44.7

all dimensions are in mm

## Receptacle with locking ring 09 type

### Embase à écrou type 09

Solder / A souder	PT09A	45109E
Crimp / A sertir	-	-

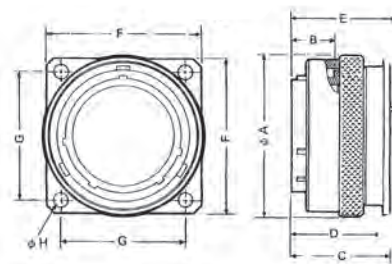

Square flange receptacle with locking ring.  
Embase à collerette carrée avec écrou de verrouillage.

Shell size Taille du boîtier	Ø A max.	B ± 0.3	C +0.5 0	D ± 0.4	E +0.7 -0.9	F ± 0.3	G ± 0.12	Ø H ± 0.1
8	18.6	9	21	19.5	22.4	20.6	15.09	3.2
10	21.4	9	21	19.5	22.4	23.8	18.26	3.2
12	25.8	9	21	19.5	22.4	26.2	20.62	3.2
14	29.0	9	21	19.5	22.4	28.6	23.01	3.2
16	32.2	9	21	19.5	22.4	31.0	24.61	3.2
18	34.9	9	21	19.5	22.4	33.3	26.97	3.2
20	38.5	10.5	24.9	22.6	26.2	36.5	29.36	3.2
22	41.7	10.5	24.9	22.6	26.2	39.7	31.75	3.2
24	44.7	10.5	26.5	24.1	26.2	42.9	34.93	3.7

## PCB and wire wrap contacts receptacle

### Embase avec contacts à piquer sur CI et contacts à wrapper

YS contacts	PT02YS	45102YS
Y contacts	PT02Y	45102Y
GS contacts	PT02GS	45102GS

Square flange receptacle / PCB contacts.  
Embase à collerette carrée / Contacts à piquer.

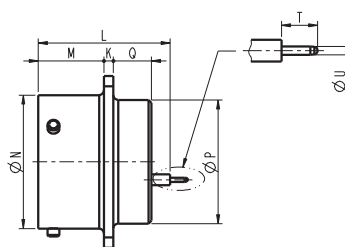

YS contacts	PT07YS	45107YS
Y contacts	PT07Y	45107Y
GS contacts	PT07GS	45107GS

Jam nut receptacle / PCB contacts.  
Embase à fixation par écrou / Contacts à piquer.

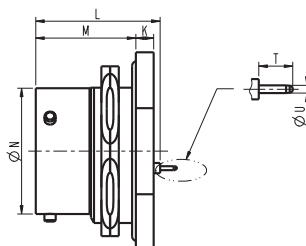

To mount the receptacle on the panel, please refer to page 58 for panel drilling and thickness.  
Please have a look at page 59 for PCB drilling dimensions.

Pour le montage des embases sur panneau, se référer à la page 58 pour le perçage et l'épaisseur des panneaux.  
Reportez-vous à la page 59 pour le perçage des circuits imprimés.

all dimensions are in mm



MW contacts    PT02MW    45102MW

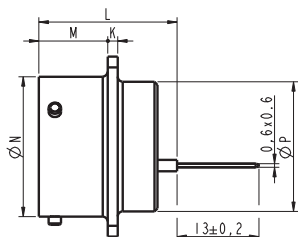

Square flange receptacle / Wire wrap contact.  
Embase à collerette carrée / Contacts à wrapper.

MW contacts    PT07MW    45107MW

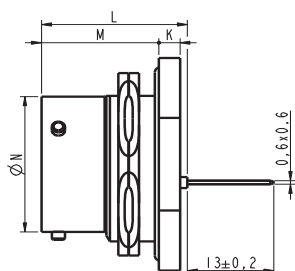

Jam nut receptacle / Wire wrap contact.  
Embase à fixation par écrou / Contacts à wrapper.

Shell size <i>Taille du boîtier</i>	K		M		Ø N	Ø P	Q
	02	07	02	07			
8	1.57	3.2	10.95	17.7	12.01	11.4	6.35
10	1.57	3.2	10.95	17.7	14.99	14.6	6.35
12	1.57	3.2	10.95	17.7	19.05	17.8	6.35
14	1.57	3.2	10.95	17.7	22.23	20.9	6.35
16	1.57	3.2	10.95	17.7	25.40	24.1	6.35
18	1.57	3.2	10.95	17.7	28.58	27.3	6.35
20	2.39	4.0	14.12	22.5	31.75	30.5	8.74
22	2.39	4.0	14.12	22.5	34.93	33.6	8.74
24	2.39	4.0	14.96	23.3	38.10	36.8	8.74

Shell size <i>Taille du boîtier</i>	T(Y) +0.2 -0	T(GS) ±0.1	T(YS) +0.2 -0	Ø U(Y) +0 -0.1	Ø U(GS) ±0.03	Ø U(YS) +0.1 -0
8	3	4.5	7	0.7	0.65	0.6
10	3	4.5	7	0.7	0.65	0.6
12	3	4.5	7	0.7	0.65	0.6
14	3	4.5	7	0.7	0.65	0.6
16	3	4.5	7	0.7	0.65	0.6
18	3	4.5	7	0.7	0.65	0.6
20	3	4.5	7	0.7	0.65	0.6
22	3	4.5	7	0.7	0.65	0.6
24	3	4.5	7	0.7	0.65	0.6

Shell size <i>Taille du boîtier</i>	L(Y) ± 0.5 (pin) / ± 1.1 (socket)	L(GS) ± 0.5 (pin) / ± 1.1 (socket)	L(YS) ± 0.5 (pin) / ± 1.1 (socket)	L(MW) ± 0.6 (pin) / ± 1.2 (socket)
8	21.96	23.16	21.96	22.8
10	21.96	23.16	21.96	22.8
12	21.96	23.16	21.96	22.8
14	21.96	23.16	21.96	22.8
16	21.96	23.16	21.96	22.8
18	21.96	23.16	21.96	22.8
20	28.73	29.23	28.73	29.6
22	28.73	29.23	28.73	29.6
24	28.73	29.23	28.73	29.6

all dimensions are in mm

## Hermetic receptacles

### Embases hermétiques

Hermetic receptacles are available with three different shell types: square flange receptacle, jam nut receptacle and solder mounting receptacle. They are only available with male solder contacts.

Les embases hermétiques sont disponibles dans trois types de boîtiers différents : embase à collerette carrée, embase à fixation par écrou et embase à fixation par brasage. Elles sont disponibles uniquement avec des contacts mâles à souder.

### General characteristics / Caractéristiques générales

- Shells in steel with tin plating finish
  - Glass insert
  - Pin contacts in nickel alloy with tin plated solder pot termination
  - Temperature range: -55°C +125°C
  - Hermeticity: Leak  $\leq 10^{-6} \text{ cm}^3 \cdot \text{s}^{-1}$  under 1 bar differential pressure
  - Vibration: exceeds MIL-E-5272 proc. II
  - Physical shock: 100 G's
  - Current rating per contact: size 20 pin: 5A / size 16 pin: 10A
  - Dielectric withstanding voltage (at sea level):  
1500 Vrms, 60 cps (service rating 1)  
2300 Vrms, 60 cps (service rating 2)
- Boîtier en acier avec traitement de surface étamé.
  - Isolant en perle de verre.
  - Contact mâle en alliage de nickel avec fût à souder étamé.
  - Gamme de température : - 55° à + 125° C.
  - Herméticité : Fuite  $\leq 10^{-6} \text{ cm}^3 \cdot \text{s}^{-1}$  sous une pression différentielle de 1 bar.
  - Résistance aux vibrations : supérieure aux clauses de la norme MIL-E-5272 proc II.
  - Résistance aux chocs : 100 G
  - Intensité max admissible par contact : contact taille 20 : 5A / contact taille 16 : 10A.
  - Tension de test (au niveau de la mer) :  
1500 Vrms, 60 Hz (service 1)  
2300 Vrms, 60 Hz (service 2).

### Overall dimensions / Dimensions

Solder / A souder	PT02H	-
Crimp / A sertir	-	-

Square flange receptacle.  
Embase à collerette carrée.

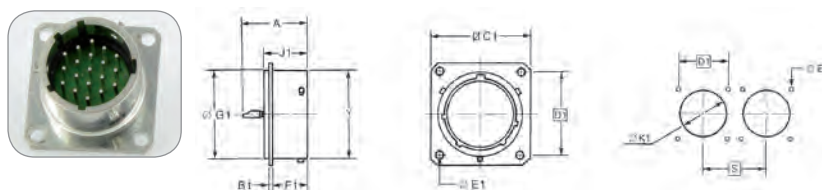

Solder / A souder	PT07H	-
Crimp / A sertir	-	-

Jam nut receptacle.  
Embase à fixation par écrou.

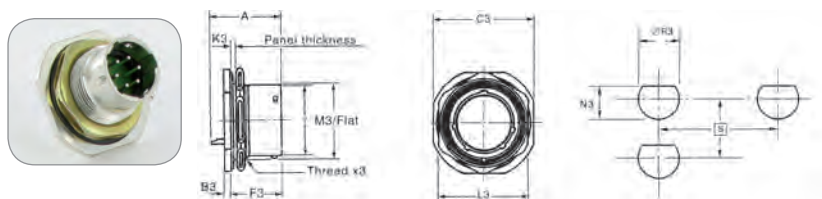

Solder / A souder	PT1H	-
Crimp / A sertir	-	-

Solder mounting receptacle.  
Embase à fixation par brasage.

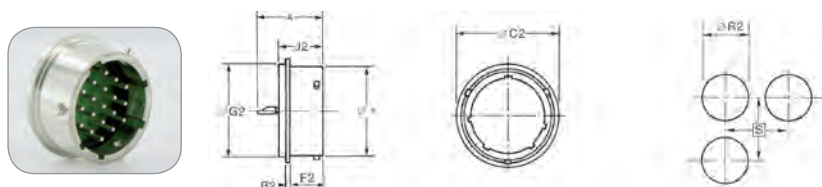

Shell size <i>Taille du boîtier</i>	A max.	B1 ± 0.13	B2 ± 0.13	B3 ± 0.13	Ø C1 ± 0.15	Ø C2 max.	C3 max.	D1	E1 min.	F1 ± 0.13	F2 ± 0.13	F3 ± 0.13	G1 ± 0.05	Ø G2 max.
8	21.03	1.57	0.91	2.39	20.62	16.00	23.93	15.09	3.05	11.25	10.82	17.93	14.22	14.27
10	21.03	1.57	0.91	2.39	23.80	19.18	27.10	18.26	3.05	11.25	10.82	17.93	17.02	17.07
12	21.03	1.57	0.91	2.39	26.19	21.56	31.88	20.62	3.05	11.25	10.82	17.93	19.79	19.84
14	21.03	1.57	0.91	2.39	28.58	24.74	35.05	23.01	3.05	11.25	10.82	17.93	22.96	23.01
16	21.03	1.57	0.91	2.39	30.94	27.91	38.23	24.61	3.05	11.25	10.82	17.93	26.14	26.19
18	21.03	1.57	0.91	2.39	33.32	31.06	41.40	26.97	3.05	11.25	10.82	17.93	29.31	29.36
20	22.61	2.36	0.91	3.18	36.50	33.45	46.15	29.36	3.05	14.25	12.40	22.71	31.70	31.75
22	22.61	2.36	0.91	3.18	39.67	36.65	49.33	31.75	3.18	14.25	12.40	22.71	34.87	34.93
24	22.61	2.36	0.91	3.18	42.85	39.80	52.50	34.92	3.18	15.06	13.23	23.55	38.05	38.10

Shell size <i>Taille du boîtier</i>	J1 ± 0.13	J2 ± 0.13	K1 ± 0.13	K3 + 1.6 - 0	L3 + 0 - 0.25	M3 + 0 - 0.13	N3 ± 0.13	Ø R2 ± 0.13	Ø R3 ± 0.13	S min.	Thread x3 (Class 2A) Filetage x3 (Classe 2A)	Y ± 0.8
8	14.91	14.91	14.43	1.57	19.05	13.39	13.72	14.68	14.53	31.75	0.5625-24 UNEF	11.96
10	14.91	14.91	17.65	1.57	22.23	16.56	16.89	17.45	17.70	34.52	0.6875-24 UNEF	14.94
12	14.91	14.91	21.95	1.57	26.97	20.70	21.03	20.24	22.48	38.89	0.8750-20 UNEF	19.00
14	14.91	14.91	25.12	1.57	30.15	23.85	24.18	23.42	25.65	42.06	1.0000-20 UNEF	22.17
16	14.91	14.91	28.27	1.57	33.32	27.00	27.33	26.59	28.83	45.24	1.1250-18 UNEF	25.35
18	14.91	14.91	31.45	1.57	36.50	30.18	30.51	29.77	32.00	48.03	1.2500-18 UNEF	28.52
20	17.27	16.48	34.62	1.57	39.67	33.35	33.68	32.16	35.18	51.59	1.3750-18 UNEF	31.70
22	17.27	17.30	37.80	1.57	42.85	36.53	36.86	35.31	38.35	54.76	1.5000-18 UNEF	34.87
24	18.08	18.14	41.02	1.57	46.02	39.70	40.03	38.51	41.53	57.84	1.6250-18 UNEF	38.05

## Through bulkhead receptacle type PTB

### *Embase traversée de cloison type PTB*

Solder / A souder	PTB	-
Crimp / A sertir	-	-

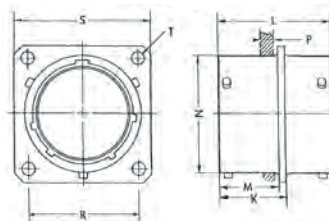

Shell size <i>Taille du boîtier</i>	K	L	M	Ø N	P max.	R	S	T ± 0.1
8	15.9	26.67	14.27	12.01	3.2	15.09	20.6	3.05
10	15.9	26.67	14.27	14.99	3.2	18.26	23.8	3.05
12	15.9	26.67	14.27	19.05	3.2	20.62	26.2	3.05
14	15.9	26.67	14.27	22.23	3.2	23.01	28.6	3.05
16	15.9	26.67	14.27	25.40	3.2	24.61	31.0	3.05
18	15.9	26.67	14.27	28.58	3.2	26.97	33.3	3.05
20	19.8	33.78	17.48	31.75	3.2	29.36	36.5	3.05
22	19.8	33.78	17.48	34.93	3.2	31.75	39.7	3.05
24	19.8	33.78	17.48	38.10	3.2	34.93	42.9	3.73

all dimensions are in mm

## Plug & receptacle without backshell 33 / 44 / 55 types

### Fiche & embase sans raccord arrière types 33 / 44 / 55

Solder / A souder	PT33A	-
Crimp / A sertir	PT33SE	-

Square flange receptacle (00 type) without backshell.  
Embase à collerette carrée (type 00) sans raccord arrière.

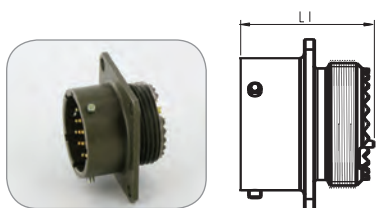

Solder / A souder

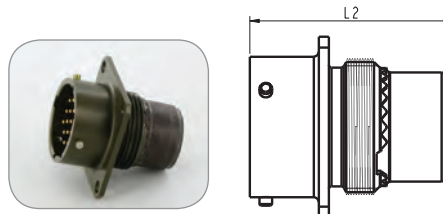

Crimp / A sertir

Solder / A souder	PT44A	-
Crimp / A sertir	PT44SE	-

Inline receptacle (01 type) without backshell.  
Prolongateur (type 01) sans raccord arrière.

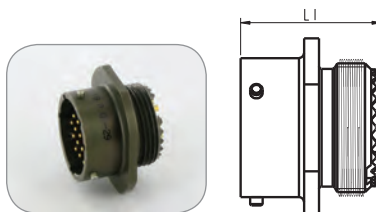

Solder / A souder

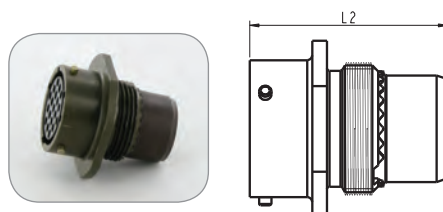

Crimp / A sertir

Solder / A souder	PT55A / PTG55A	-
Crimp / A sertir	PT55SE / PTG55SE	-

Plug (06 type) without backshell. PTG version with grounding ring.  
Fiche (type 06) sans raccord arrière. Version PTG avec bague de masse.

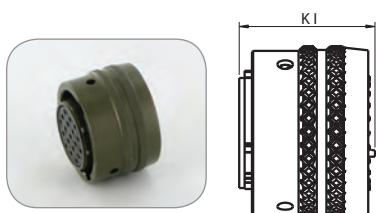

Solder / A souder

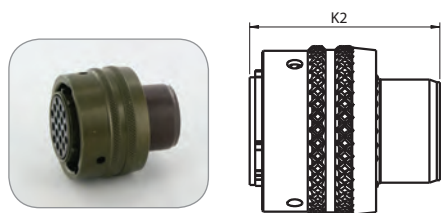

Crimp / A sertir

Shell size Taille du boîtier	K1 max.	K2 max.	L1 max.	L2 max.	Rear thread (class 2A) Filetage arrière (classe 2A)
8	22.3	32.3	22.7	32.4	0.4375-28 UNEF
10	22.3	32.3	22.7	32.4	0.5625-24 UNEF
12	22.3	32.3	22.7	32.4	0.6875-24 UNEF
14	22.3	32.3	22.7	32.4	0.8125-20 UNEF
16	22.3	32.3	22.7	32.4	0.9375-20 UNEF
18	22.3	32.3	22.7	32.4	1.0625-18 UNEF
20	26.3	32.3	28.3	33.9	1.1875-18 UNEF
22	26.3	32.3	28.3	33.9	1.3125-18 UNEF
24	26.3	34.0	28.3	35.4	1.4375-18 UNEF

all dimensions are in mm

How to order / *Comment commander***PT series****PT****G****55****A****16****8****P****-****-****G:** With grounding ring (for 55 plug shell only)**Shell type:****33:** 00 type / Square flange receptacle style with serrations**44:** 01 type / Inline receptacle style with serrations**55:** 06 type / Plug shell with serrations**Contact type:****A:** Solder version**SE:** Crimp version**Connector shell size:** 8/10/12/14/16/18/20/22/24**Contact insert arrangement:** (See page 10 & 11)**Contact type:****P:** Pin**S:** Socket**Coding / Insert alternate positioning:**

Blank for normal or W, X, Y, Z (see coding system page 9).

**Shell finish:**

Omit for standard olive drab cadmium.

**01:** Bright cadmium**02:** Black anodised - ROHS compliant**023:** Electroless nickel - ROHS compliant**Série PT****PT****G****55****A****16****8****P****-****-****G:** Avec bague de masse (pour fiche 55 uniquement)**Type de boîtier :****33 :** Type 00 / Embase à collerette carrée avec arrière cranté**44 :** Type 01 / Prolongateur avec arrière cranté**55 :** Type 06 / Fiche avec arrière cranté**Type de contact :****A :** Version à souder**SE :** Version à sertir**Taille de boîtier :** 8/10/12/14/16/18/20/22/24**Arrangement de contact :** (voir page 10 et 11)**Type de contact :****P :** Mâle**S :** Femelle**Système de codage / Orientation de l'isolant :**

Néant pour normal ou W, X, Y, Z (voir le système de codage page 9).

**Traitement du boîtier :**

Néant pour le cadmié vert olive.

**01 :** Cadmié blanc**02 :** Oxydation anodique noire - conforme ROHS**023 :** Nickel chimique - conforme ROHS

## PTSA backshell

### Raccord arrière PTSA

#### General characteristics / Caractéristiques générales

- Compatible with the **crimp and solder** versions and with 33, 44 & G55 shell types.
  - High EMI-RFI protection level.
  - Clamping braid backshell by screwing system with free inner ring **to avoid twisting of the braid during screwing**.
  - Sealed when equipped with straight or right angled heatshrink moulded piece mentioned on page 57.
  - User friendly, no tooling required
- Compatible avec les versions **à sertir et à souder** et avec les types de boîtiers 33, 44 et G55.
  - Excellent niveau de protection EMI.
  - Raccord à reprise de tresse par un système de vissage avec une bague intérieure indépendante qui permet d'**éviter la torsion de la tresse au moment du vissage**.
  - Étanche lorsqu'il est équipé d'une pièce moulée thermorétractable droite ou coudée, telle que mentionnée page 57.
  - Facile à utiliser, aucun outil n'est nécessaire.

#### Overall dimensions / Dimensions

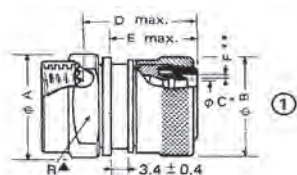

PTSA alone  
PTSA seul

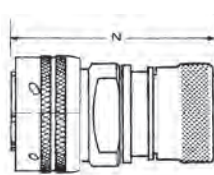

G55 shell type + PTSA  
Boîtier type G55 + PTSA

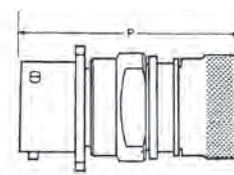

33 or 44 shell types + PTSA  
Boîtier type 33 ou 44 + PTSA

Shell size Taille du boîtier	A ±0.2	B	C max.*	D	E	F max.**	N max.	P max.	R
8	20	16.0	6.9	36.2	23	1	58	50.7	16.8
10	24	18.9	9.6	36.2	23	1	58	50.7	20.8
12	26	22.1	12.7	36.2	23	1	58	51.2	22.8
14	29	25.3	14.8	38.2	25	1	60	52.9	25.8
16	32	28.5	18.0	38.2	25	1.1	60	53.8	31.8
18	35	31.5	19.9	39.2	26	1.2	61	53.8	31.8
20	38	34.7	23.1	36.3	23.1	1.25	62	64	35.8
22	42	37.9	26.2	36.3	23.1	1.25	62	64	38.8
24	45	41.0	28.8	36.3	23.1	1.25	64	70.6	41.8

\* : Acceptable outside diameter of the cable / Diamètre extérieur du câble admissible

\*\* : Braid thickness / Épaisseur de la tresse

R : Dimension on flat (4 flats) / Cote sur plat (4 plats)

#### How to order / Comment commander

PTSA Series    PTSA    10    1    -

Backshell size corresponding to connector shell size:  
8/10/12/14/16/18/20/22

1: Corresponding to standard braid thickness

##### Shell finish:

Omit for standard olive drab cadmium.

01: Bright cadmium

07: Electroless nickel - ROHS compliant

Série PTSA    PTSA    10    1    -

Taille du raccord correspondant à la taille du connecteur :  
8/10/12/14/16/18/20/22

1 : Correspondant à l'épaisseur de tresse standard

##### Traitement du boîtier :

Néant pour le cadmié vert olive.

01 : Cadmié blanc

07 : Nickel chimique - conforme ROHS

all dimensions are in mm

## Rugged RJ45 Solutions *Solutions RJ45 renforcées*

### Presentation / *Présentation*

#### **RJF - Ethernet connection system for harsh environment - Industrial Ethernet**

*RJF - Liaison Ethernet pour environnement sévère - Ethernet Industriel*

RJF allows you to use an Ethernet Class D / Cat. 5E connection for 10 BaseT, 100 BaseTX or 1000 BaseT networks in harsh environment.

With the patented RJStop® system you can use a standard RJ45 cordset in a metallic plug which will protect it from shocks, dust and fluids.

**No hazardous on-field cabling and grounding!**

**Website: [www.rjfield.com](http://www.rjfield.com)**



*Avec RJField vous réalisez une liaison Ethernet Classe D / Cat. 5E pour réseaux 10 BaseT, 100 BaseTX ou 1000 BaseT en milieu sévère.*

*Le système breveté RJStop® permet d'utiliser un cordon RJ45 standard dans une enveloppe protectrice (fiche) le mettant à l'abri des chocs, de la poussière et des projections de liquide.*

*Ce système permet de s'affranchir de tout raccordement terrain, y compris des délicates reprises de blindage.*

**Site web : [www.rjfield.com](http://www.rjfield.com)**

### Applications / *Applications*

- |  |   |
|--|---|
| ■ Robotics   | ■ Robotique   |
| ■ Industrial Process Control                             | ■ Contrôle de Process Industriel                          |
| ■ CNC Machines   | ■ Machine Outil   |
| ■ Special Machines                                       | ■ Machines spéciales                                      |
| ■ Oil & Gas  | ■ Recherche et prospection de pétrole                     |
| ■ Motion Control   | ■ Contrôle de motricité                                   |
| ■ Data Acquisition and Transmission in Harsh Environment | ■ Acquisition et transmission de données en milieu sévère |
| ■ Tele-maintenance                                       | ■ Télémaintenance   |

### Data transmission / *Transmission des données*

10 BaseT, 100 BaseTX and 1000 BaseT networks  
Cat 5E per TIA/EIA 568B and ClassD per ISO/IEC 11801

*Réseaux 10 BaseT, 100 BaseTX et 1000 BaseT  
Cat 5E selon TIA/EIA 568B et Classe D selon ISO/IEC 11801*



## Main characteristics / *Principales caractéristiques*

- Compliant with IEC 60603-7 variant 11
- Bayonet coupling ("Audible & Visual" coupling signal )
- Robust metallic shells based on MIL-DTL-26482 H
- RJ45 cordset retention in the plug: 100 N in the axis
- Mating cycles: 500 min.
- Sealed against fluids and dust (IP68)
- Shock, Vibration and Traction resistant
- No cabling operation in field and no tools required
- Mechanical Coding / Polarization (4 positions)
- Compatible with cable diameter from 5,5 mm [0.216 in] to 13 mm [0.512 in]
  
- *Conforme à l'IEC60603-7 variante 11*
- *Verrouillage baïonnette (clic de verrouillage sensitif et auditif)*
- *Boîtiers métalliques robustes basés sur la norme MIL-DTL-26482 H*
- *Tenue du cordon RJ45 dans la fiche: 100 N dans l'axe*
- *Nombre de manoeuvres : 500 min.*
- *Étanche aux fluides et à la poussière (IP68)*
- *Résiste aux chocs, aux vibrations et tractions*
- *Aucune opération de câblage, aucun outil*
- *4 possibilités de détrompage mécanique (rotation des inserts)*
- *Compatible avec les diamètres de câbles de 5,5 mm à 13 mm*

## Environmental characteristics / *Caractéristiques environnementales*

- |                                 |   |
|---------------------------------|---|
| ■ Sealing:                      | IP68  |
| ■ Salt Spray:                   | 48 h with Nickel plating<br>> 96 h with Black coating<br>> 500 h with Olive Drab Cadmium plating                    |
| ■ Fire Retardant/Low Smoke:     | UL94 V0 and NF F 16 101 & 16 102  |
| ■ Vibrations:                   | 10 – 500 Hz, 10 g, 3 axes: no discontinuity > 10 nano s.  |
| ■ Shocks:                       | IK06: weight of 250 g drop from 40 cm<br>[15.75 in] onto connectors (mated pair)                                    |
| ■ Humidity:                     | 21 days, 43°C, 98% humidity   |
| ■ Thermal Shock:                | 5 cycles at - 40°C / +100°C   |
| ■ Temperature Range:            | - 40°C / +85°C  |
|                                 |   |
| ■ <i>Étanchéité :</i>           | <i>IP68</i>   |
| ■ <i>Brouillard salin :</i>     | <i>48 h avec protection Nickelée<br/>&gt; 96 h avec Electrophorèse noire<br/>&gt; 500 h avec Cadmium vert olive</i> |
| ■ <i>Feu / Fumée :</i>          | <i>UL94 V0 et conforme à NF F 16 101 &amp; 16 102</i>   |
| ■ <i>Vibrations :</i>           | <i>10 – 500 Hz, 10 g, 3 axes : pas de micro coupure &gt; 10 nano s.</i>   |
| ■ <i>Chocs :</i>                | <i>IK06: soit chute d'une de masse de 250 g de 40 cm<br/>sur connecteurs accouplés</i>                              |
| ■ <i>Humidité :</i>             | <i>21 jours, 43°C, humidité 98%</i>   |
| ■ <i>Choc thermetique :</i>     | <i>5 cycles - 40°C / +100°C</i>   |
| ■ <i>Gamme de température :</i> | <i>- 40°C / +85°C</i>   |

How to order / *Comment commander*

RJField Series	RJF	2	2	B	03 100BTX
<b>Shell Type:</b> <b>6:</b> Plug, IP68 backshell, plastic gland <b>6M:</b> Plug, IP68 backshell, metal gland <b>2:</b> Square Flange Receptacle <b>2PE:</b> Square Flange Receptacle, IP68 backshell, plastic gland <b>2PEM:</b> Square Flange Receptacle, IP68 backshell, metal gland <b>7:</b> Jam Nut Receptacle <b>7PE:</b> Jam Nut Receptacle, IP68 backshell, plastic gland <b>7PEM:</b> Jam Nut Receptacle, IP68 backshell, metal gland <b>2SA, 7SA:</b> Transversally sealed receptacle (unmated)					
<b>Back Termination (for receptacles only) :</b> <b>1:</b> Female RJ45 <b>1RA:</b> Right Angle Female RJ45 <b>2:</b> RJ45 Cordset					
<b>Shell Finish:</b> <b>B:</b> Black Coating - ROHS compliant <b>N:</b> Nickel (Note: with this version, the inserts are metallized) - ROHS compliant <b>G:</b> Olive Drab Cadmium (Note: with this version, the inserts are metallized)					
<b>Cordset Length (for receptacles with type "2" back termination only):</b> <b>03 100BTX:</b> 0.3m [11.81 inches] <b>05 100BTX:</b> 0.5m [19.68 inches] <b>10 100BTX:</b> 1m [39.37 inches] <b>15 100BTX:</b> 1.5m [59.05 inches] <b>00:</b> 8 tinned holes at the rear of the PCB to solder the cable					

**Remark:** Cabling configuration: 100 BTX = 568B (Ethernet specification)

**Examples:**

- Nickel plug: RJF 6 N s
- Black square flange receptacle, female RJ45 back termination: RJF 2 1 B
- Olive drab cadmium jam nut receptacle, 1.5 m [59.05"] cordset back termination: RJF 7 2 G 15 100BTX
- Black square flange receptacle, backshell with plastic gland, 30 cm [11.81"] cordset back termination: RJF 2PE 2 B 03 100BTX
- Nickel jam nut receptacle, solder termination: RJF 72 N 00

Série RJField	RJF	2	2	B	03 100BTX
<b>Type de boîtier :</b> <b>6 :</b> Fiche avec presse étoupe plastique <b>6M :</b> Fiche avec presse étoupe métallique <b>2 :</b> Embase à collerette carrée <b>2PE :</b> Embase à collerette carrée et raccord presse étoupe plastique <b>2PEM :</b> Embase à collerette carrée et raccord presse étoupe métallique <b>7 :</b> Embase à écrou <b>7PE :</b> Embase à écrou et raccord presse étoupe plastique <b>7PEM :</b> Embase à écrou et raccord presse étoupe métallique <b>2SA, 7SA :</b> Embase étanche en traversée (désaccouplée)					
<b>Type de sortie (seulement pour les embases) :</b> <b>1 :</b> Femelle RJ45 <b>1RA :</b> Femelle RJ45 coudée à 90° <b>2 :</b> Cordon RJ45					
<b>Protection du boîtier :</b> <b>B :</b> Electrophorèse noire <b>N :</b> Nickel (Note: dans cette version, les inserts sont métallisés) <b>G :</b> Cadmié vert olive (Note: dans cette version, les inserts sont métallisés)					
<b>Longueur du cordon (pour embase type 2 seulement) :</b> <b>03 100BTX :</b> 0.3m <b>05 100BTX :</b> 0.5m <b>10 100BTX :</b> 1m <b>15 100BTX :</b> 1.5m <b>00 :</b> 8 trous étamés à l'arrière du PCB pour permettre de souder un câble					

**Remarque :** Configuration de câblage : 100 BTX = 568B (spécification Ethernet)

**Exemples :**

- Fiche nickel : RJF 6 N
- Embase carrée, noire, sortie femelle RJ45 : RJF 2 1 B
- Embase à écrou, cadmié vert, sortie cordon 1.5 m : RJF 7 2 G 15 100BTX
- Embase carrée, noire, raccord presse étoupe plastique, sortie cordon 30 cm : RJF 2PE 2 B 03 100BTX
- Embase à écrou, nickel, sortie à souder : RJF 72 N 00

Overall dimensions / *Dimensions*Plug / *Fiche*

Shell type 6 with Plastic or Metal Gland

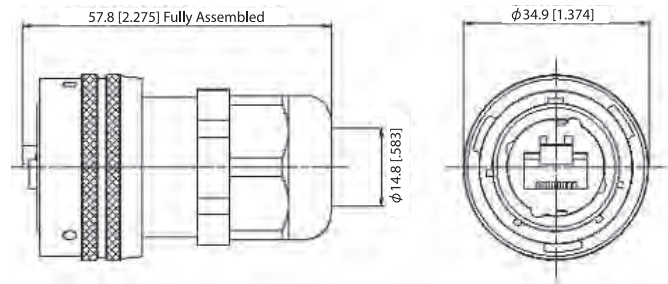
*Boîtier type 6 avec presse étoupe plastique ou métallique*Receptacles / *Embases*

Square flange receptacle: Shell type 2

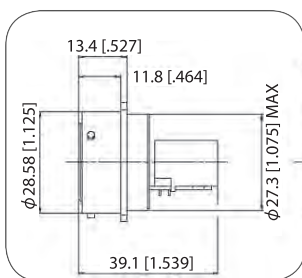
*Embase carrée : Boîtier type 2*

RJF 21 x  
Straight Female RJ45  
*Sortie RJ45 droite*

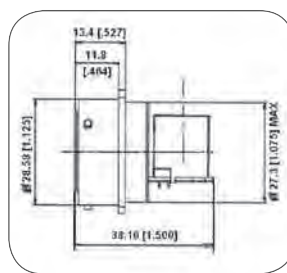

RJF 21 RA x  
Right Angle Female RJ45  
*Sortie RJ45 coudée*

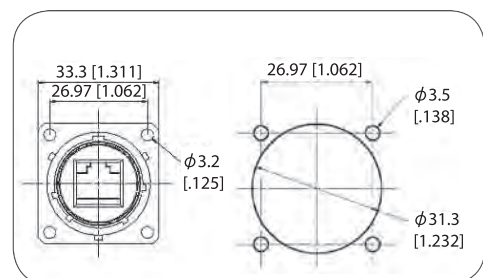

Panel Drilling  
*Découpe de Panneau*

Jam nut receptacle: Shell type 7

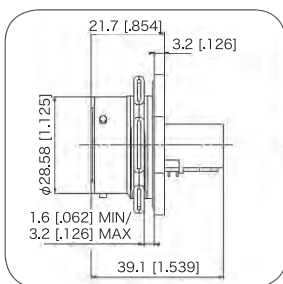
*Embase à écrou : Boîtier type 7*

RJF 71 x  
Straight Female RJ45  
*Sortie RJ45 droite*

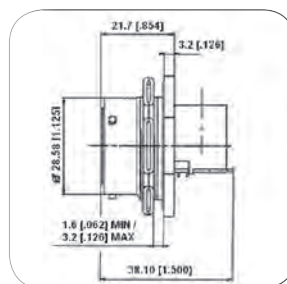

RJF 71 RA x  
Right Angle Female RJ45  
*Sortie RJ45 coudée*

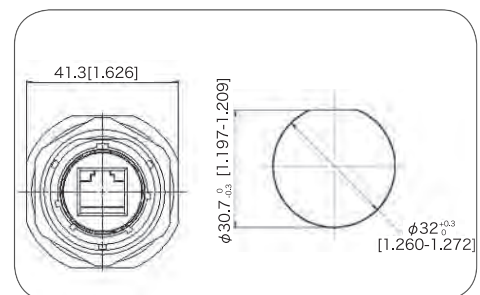

Panel Drilling  
*Découpe de Panneau*

Receptacles with IP68 backshell: Shell types 2PE and 7PE with plastic or metal gland

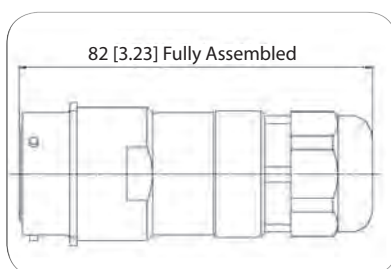
*Embases avec raccord IP68 : Boîtier types 2PE et 7PE avec presse étoupe plastique ou métallique*

RJF 2PE / 2PEM

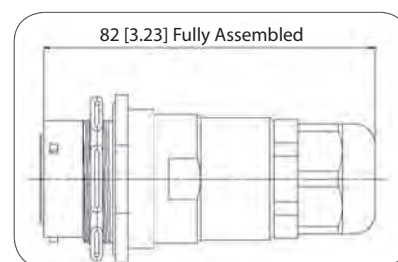

RJF 7PE / 7PEM

Back Terminations / *Types de sortie*

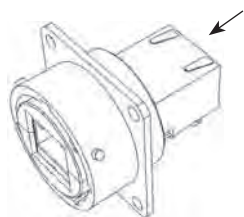

Type 1: Female RJ45  
Sortie 1 : Femelle RJ45

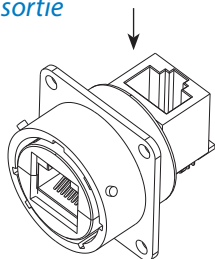

Type 1RA: Right Angle Female RJ45  
Sortie 1RA : Femelle RJ45 coudée

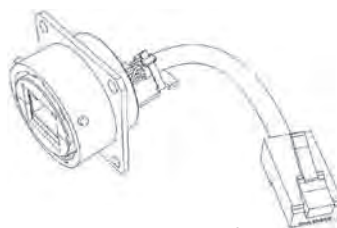

Type 2: RJ45 Cordset  
Sortie 2 : Cordon RJ45

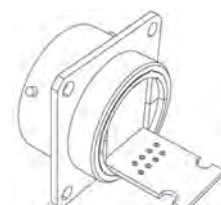

Type 2 - 00: Solder - 8 tinned holes  
Sortie 2-00 : A souder - 8 trous étamés

Note: Type 2 without RJ45 plug at the end of the cable is also available: consult factory  
Remarque : La sortie 2 est aussi disponible avec un câble sans fiche RJ45 à l'extrémité (nous consulter pour plus d'informations)

Assembly instructions / *Instructions d'assemblage*

**Universal:** Can be used with all standard RJ45 Cat 5E cordset brands.

**Universel :** Utilisable avec toute marque de cordon RJ45 Cat 5E standard.

1. Push down the RJ45 cordset latch, and fix it inside the insert
2. Press in and click the other part of the insert
3. Insert in the metal housing

1. Pliez la languette de la fiche RJ45 et insérez la fiche dans le logement du demi-isolant
2. Clipsez la deuxième partie de l'isolant
3. Insérez la fiche et l'isolant dans le boîtier métallique

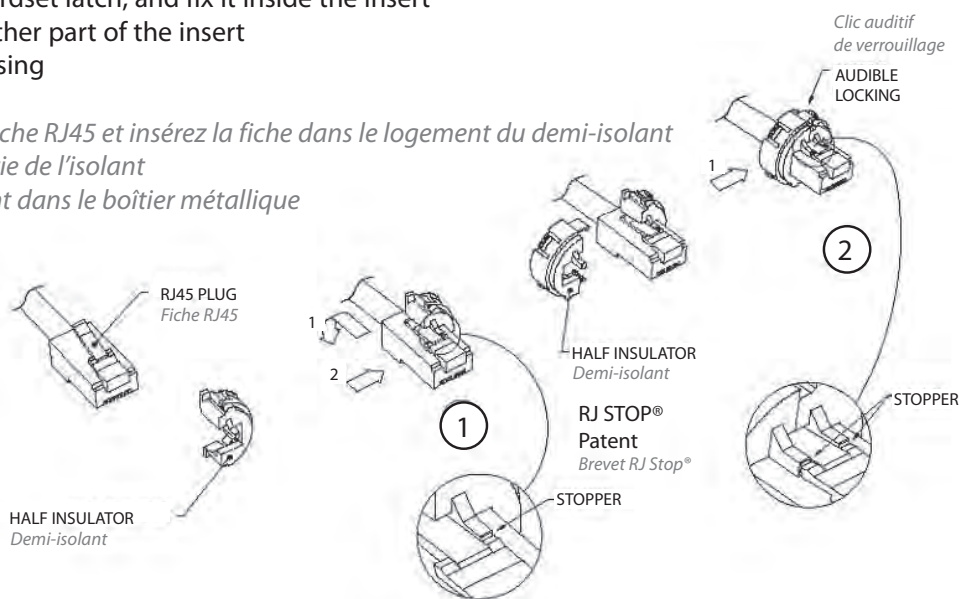

**Easy and Safe:** No field cabling, no tool required

**Facile et sûr:** Aucune opération de câblage, aucun outil

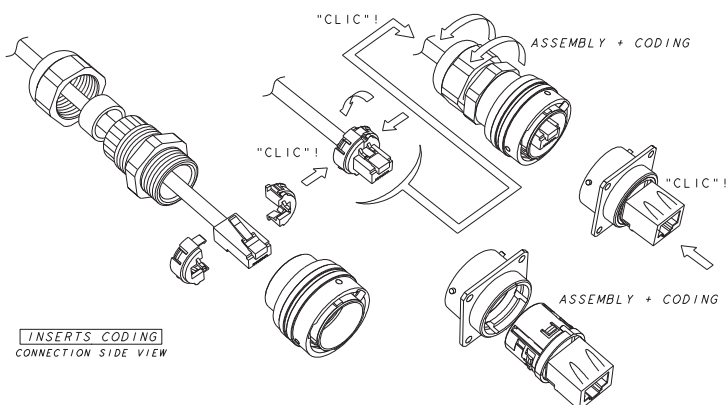

Coding system / *Système de codage*

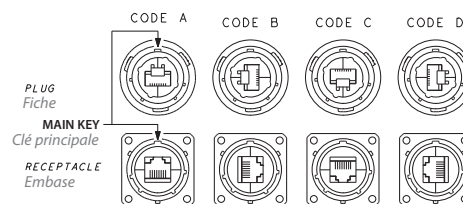

## Special receptacles / *Embases spéciales*

### Inline receptacle / *Prolongateur*

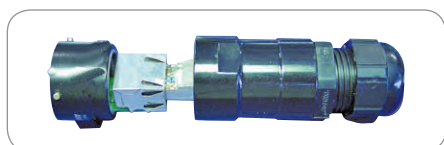

Inline receptacles allow you to make cable extensions in the field by using them with rugged RJFied series plugs.

*Les prolongateurs permettent de connecter des câbles bout à bout sur le terrain en assurant une étanchéité et une résistance mécanique.*

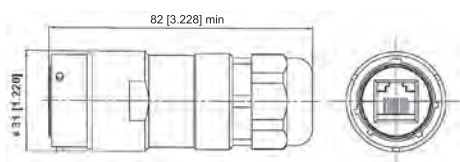

### Part numbers / *Références produit*

- |   |   |   |
|---|---|---|
| ■ <b>Plastic Gland</b><br>Black coating<br>Nickel plating<br>Olive Drab Cadmium plating | ■ <b>Presse étoupe plastique</b><br><i>Protection noire</i><br><i>Protection nickel</i><br><i>Protection cadmium vert olive</i> | <b>RJF2PEWF1B</b><br><b>RJF2PEWF1N</b><br><b>RJF2PEWF1G</b> |
| ■ <b>Metal Gland</b><br>Black coating<br>Nickel plating<br>Olive Drab Cadmium plating   | ■ <b>Presse étoupe plastique</b><br><i>Protection noire</i><br><i>Protection nickel</i><br><i>Protection cadmium vert olive</i> | <b>RJF2PEMF1B</b><br><b>RJF2PEMF1N</b><br><b>RJF2PEMF1G</b> |

### PCB receptacles / *Embases PCB*

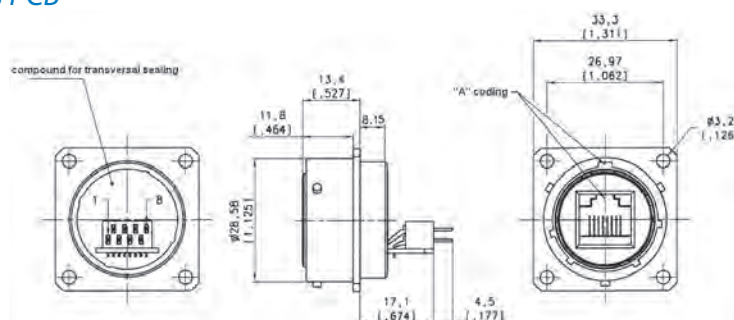

These receptacles can be soldered directly on your PCB. A compound insures a transversal sealing and good performance in high vibration environments. They can be connected with rugged RJField series plugs.

*Ces embases sont destinées à être soudées sur un circuit imprimé. Le compound permet une étanchéité en traversée et une meilleure résistance aux vibrations. Les fiches renforcées de la série «RJF» peuvent être utilisées avec ces embases.*

#### Note :

1. Platings available : "B" : black coating • "N" : nickel plating • "G" : olive drab cadmium plating
2. As these receptacles are compounded, coding position has to be specified in the P/N.

#### Note :

1. Protections disponibles : "B" : protection noire • "N" : protection Nickel • "G" : protection cadmiée vert olive
2. Les embases étant compoundées, la position du codage doit être spécifiée dans la référence

### Part numbers (examples) / *Références produit (exemples)*

- |  |   |           |                 |
|--|---|-----------|-----------------|
| Square flange receptacle, black coating  | <i>Embase carrée, protection noire</i>  | coding A: | <b>RJF2SA5B</b> |
| Square flange receptacle, nickel plating | <i>Embase carrée, protection nickel</i> | coding C: | <b>RJF2SC5N</b> |
| Square flange receptacle, ODC plating    | <i>Embase carrée, protection CVO</i>    | coding D: | <b>RJF2SD5G</b> |



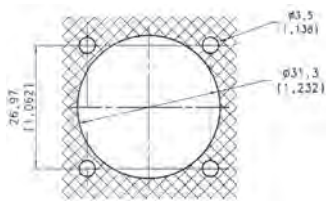

Panel Drilling  
Découpe de Panneau

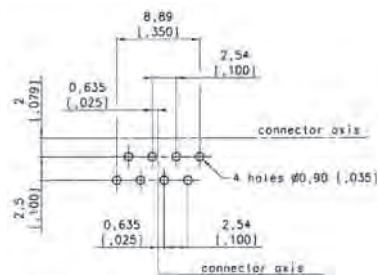

PCB layout - Solder face view  
Perçage circuit imprimé - Vue face à souder

Accessories / *Accessoires*

Metal cap / *Bouchon métallique*

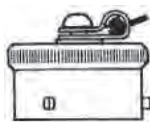

Plug Cap  
Bouchon de fiche



Receptacle Cap  
Bouchon d'embase

Termination of the cord  
Type de fixation de la cordelette

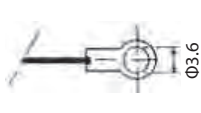

Square flange receptacle type "2"  
Embase type 2

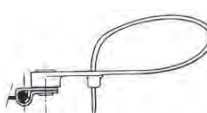

Plug type "6"  
Fiche type 6



Jam nut receptacle type "7"  
Embase type 7

RJF Caps	RJFC	2	B
<b>Connector Type:</b>			
6: Plug			
2: Square Flange Receptacle			
7: Jam Nut Receptacle			
<b>Finish:</b>			
B: Black Coating - ROHS compliant			
N: Nickel - ROHS compliant			
G: Olive Drab Cadmium			

Bouchons RJF	RJFC	2	B
<b>Type de boîtier :</b>			
6 : Fiche			
2 : Embase carrée			
7 : Embase à écrou			
<b>Traitement du boîtier :</b>			
B : Electrophorèse noire - conforme ROHS			
N : Nickel - conforme ROHS			
G : Cadmié Vert Olive			

Panel gasket for square flange type "2" / *Joint de panneau pour embase de type "2"*

- Thickness: 0,6 mm
- P/N: JE 18
- Épaisseur : 0,6 mm
- Référence : JE18

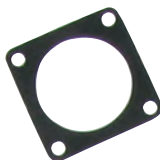

Insert removal tool for receptacle and plug / *Outils d'extraction des inserts pour embase et fiche.*

- P/N: RJF ODE
- Référence : RJF ODE

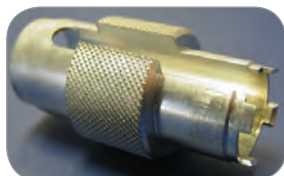



Protective caps / *Bouchons de protection*

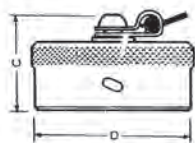

Protective cap for 00, 01, 02 and 07 shell types  
*Bouchons de protection pour les types de boîtiers 00, 01, 02 et 07*

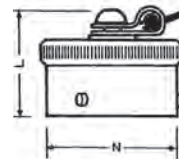

Protective cap for 06 & 08 shell types  
*Bouchons de protection pour les types de boîtiers 06 et 08*

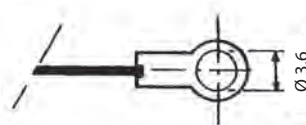

Termination of the nylon cord (or metal chain) for 00, 02 shell types protective caps.

*Type de fixation de la cordelette nylon (ou chaînette métallique) pour les bouchons de protection des types de boîtiers 00, 02.*

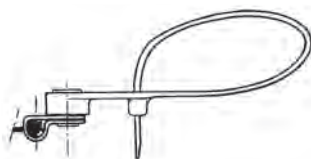

Termination of the nylon cord for 06, 08, 01 shell types protective caps (there is no termination on the metal chain).

*Type de fixation de la cordelette nylon pour les bouchons de protection des types de boîtiers 06, 08, 01 (il n'y a aucune fixation sur la chaînette métallique).*

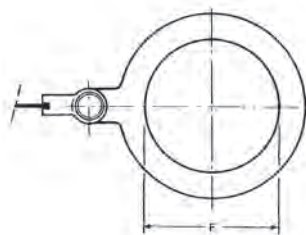

Termination of the nylon cord (or metal chain) for 07 shell type protective caps.

*Type de fixation de la cordelette nylon (ou chaînette métallique) pour les bouchons de protection des types de boîtiers 07.*

**Length of the nylon cord (or metal chain)**

From the protective cap to the cord / chain extremity:

- 160 mm long for 01, 06, 08 shell types protective caps.
- 105 mm long for 00, 02, 07 shell types protective caps.

**Longueur de la cordelette nylon (ou chaînette métallique)**

*A partir du bouchon de protection jusqu'à l'extrémité de la cordelette / chaînette :*

- 160 mm pour les bouchons de protection des types de boîtiers 01, 06 et 08.
- 105 mm pour les bouchons de protection des types de boîtiers 00, 02 et 07.



Shell size <i>Taille du boîtier</i>	C	Ø D max.	Ø F	L max.	Ø N
8	20	17.9	14.7	18.2	12.01
10	20	20.7	17.9	18.2	14.99
12	20	25.4	22.6	18.2	19.05
14	20	28.7	25.8	18.2	22.23
16	20	31.9	29.0	18.2	25.40
18	20	34.7	32.2	18.2	28.58
20	20	38.0	35.3	19.8	31.75
22	20	41.2	38.5	19.8	34.93
24	21	44.3	41.7	20.6	38.10

**PT / 451 Caps****B****ER****N**

-

**08**

-

**Protective cap type:****F:** For plug**EC:** For square flange receptacle**ER:** For jam nut receptacle**P:** For inline receptacle**Wire type:****N:** Nylon cord (standard version)

Blank for metal chain

**PT:** For plugs with nylon cord only

Omit for all other versions and for metal chain

**Corresponding connector shell size:** 8/10/12/14/16/18/20/22/24**Finish:**

Blank for olive-drab cadmium.

**01:** Bright cadmium**02:** Black anodised - ROHS compliant**07:** Electroless nickel - ROHS compliant**Bouchons PT / 451****B****ER****N**

-

**08**

-

**Types de bouchons de protection :****F:** Pour fiche**EC:** Pour embase carrée**ER:** Pour embase à écrou**P:** Pour prolongateur**Type de corde :****N:** Cordelette nylon (version standard)

Néant pour chaînette métallique

**PT:** Pour fiches avec cordelette nylon seulement

Néant pour toutes les autres versions et les chaînettes métalliques

**Taille de boîtier du connecteur correspondant :** 08/10/12/14/16/18/20/22/24**Traitement de surface :**

Néant pour cadmié vert olive.

**01 :** Cadmié blanc**02 :** Oxydation anodique noire - conforme ROHS**07 :** Nickel chimique - conforme ROHS

## Snap caps / *Bouchons à fermeture automatique*

Problems with your connectors because the caps were never used?  
What about a solution that ensures automatic sealing with each connection?

Amphenol Socapex introduces a new accessory for PT / 451 series : **the SNAP CAP!**

This Self Closing Cap mounted with a square flange receptacle protects your system against dust and water intrusion. A built in spring enables the device to automatically close on the receptacle when the plug is removed. To install just place the cap on the square flange receptacle and use your standard screws.

- Four sizes are available: 8, 10, 12 & 18.
- **IP54** - Protection against water spray and dust
- How to order:  
Add "SCC" at the end of the part number for a square flange receptacle type 02 or 00  
Ex: PT02A1210P023 **SCC** / 45102E1210P5070 **SCC**

*Combien de fois avez-vous vu un bouchon pendre à côté de son embase ?  
Que pensez-vous d'une solution qui assure une étanchéité systématique sur vos embases ?*

*Amphenol Socapex introduit une nouveauté dans la gamme PT/451: **le SNAP CAP!***

*Ce bouchon à fermeture automatique associé à une embase à collerette carrée protège votre système de la poussière et des projections d'eau. Sa spécificité réside dans un clapet qui se rabat automatiquement sur la partie supérieure de l'embase lorsque la fiche est déconnectée. Pour l'installer, placer le bouchon sur l'embase et utiliser vos vis habituelles.*

- *Quatre tailles sont aujourd'hui disponibles pour ce bouchon : 8, 10, 12 et 18*
- **IP54** - Protection contre les projections d'eau et poussières
- *Comment commander :*  
*Ajouter " SCC " à la fin de votre référence PT ou 451 d'embase carrée type 02 ou 00*  
*Ex: PT02A1210P023 **SCC** / 45102E1210P5070 **SCC***



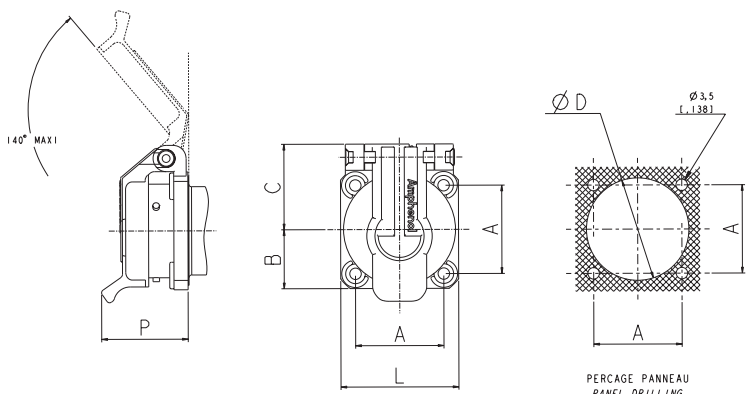

Shell size <i>Taille du boîtier</i>	P	A	B	C	L	D +0 -0.3
8	23	15.09	12	20	23.6	13
10	24	18.26	15.5	22.5	26.7	16.2
12	24	20.62	17.5	24	29	19.4
18	27	26.97	18.5	26.5	37	28.9

Our Self Closing Caps are available with the following inserts:  
 Nos bouchons automatiques SCC sont disponibles avec les arrangements suivants :

- 1 Insert arrangement reference / *Arrangements de contacts*
- 2 Number of contacts / *Nombre de contacts*
- 3 Contact size / *Taille des contacts*

08	1	8-2	8-3	8-3A (8-98)	8-33	8-4
	2	2	3	3	3	4
	3	20	20	20	20	20
10	1	10-6	10-98	10-7		
	2	6	6	7		
	3	20	20	20		
12	1	12-3	12-8	12-10	12-14	
	2	3	8	10	14	
	3	16	20	20	20	
18	1	18-11	18-30	18-32		
	2	11	29	32		
	3	16	20	20		







C: Available in crimp version  
 C : *Disponible en version à sertir*

P: For those arrangements, please contact us for available configurations. Only available with PT marking  
 P : *Pour ces arrangements, nous consulter pour les configurations possibles. Marquage PT seulement*

Top-runners / *Les plus standard*

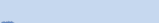

## Contacts and sealing plugs / *Contacts et obturateurs*

Crimp contacts are delivered with the connector and are mentioned here as spare parts.  
*Les contacts à sertir sont livrés avec le connecteur et sont mentionnés ici en tant que pièces détachées.*

Designation <i>Désignation</i>	Pictures <i>Photos</i>	Part number <i>Référence</i>
Size 20 pin contact <i>Contact mâle taille 20</i>		800 600
Size 20 socket contact <i>Contact femelle taille 20</i>		800 615
Size 16 pin contact <i>Contact mâle taille 16</i>		800 620
Size 16 socket contact <i>Contact femelle taille 16</i>		800 635
Reducing sleeve for size 20 contact <i>Manchon réducteur pour contact taille 20</i>		800 609
Sealing plug size 20 <i>Obturateur taille 20</i>		900 021
Sealing plug size 16 <i>Obturateur taille 16</i>		900 020

## Dummy receptacle, panel gasket, plastic dust cap

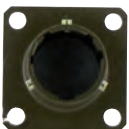
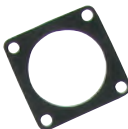

*Embase de repos, joint de panneau, bouchon de protection plastique*

Shell size <i>Taille du boîtier</i>	Dummy receptacle <i>Embase de repos</i>	Panel gasket for square flange receptacle (thickness: 0.6 mm) <i>Joint de panneau pour embase carrée (ép: 0,6mm)</i>	Plastic dust cap for plug <i>Bouchon de protection plastique pour fiche</i>	Plastic dust cap for receptacle <i>Bouchon de protection plastique pour embase</i>
				
8	FE 08	JE 08	805 412	805 411
10	FE 10	JE 10	805 413	805 412
12	FE 12	JE 12	606 064	805 413
14	FE 14	JE 14	606 073	805 414
16	FE 16	JE 16	606 066	805 415
18	FE 18	JE 18	606 067	805 416
20	FE 20	JE 20	606 068	805 417
22	FE 22	JE 22	606 069	805 418
24	FE 24	JE 24	606 079	606 069

## Heatshrink moulded piece for rear accessory *Manchon thermorétractable pour raccord arrière*



Heatshrink moulded pieces compatible with following rear accessories: **SQ, J** (backshell delivered with the connector) / **PTSA** (backshell delivered separately):

*Pièces moulées thermorétractables compatibles avec les accessoires arrière suivants : SQ, J (raccord livré avec le connecteur) / PTSA (raccord livré séparément) :*

Shell size <i>Taille du boîtier</i>	8	10	12	14	16	18	20	22	24	
<b>Straight piece</b> <i>Pièce droite</i>	804221	804222	804223	804223	804225	804225	804227	804227	804229	
<b>Right angle piece</b> <i>Pièce coudée</i>	804231	804232	804233	804233	804235	804235	804237	804237	804239	

Heatshrink moulded pieces compatible with **PT06G** and **PT08G** connectors:

*Pièces moulées thermorétractables compatibles avec les connecteurs PT06G et PT08G :*

Shell size <i>Taille du boîtier</i>	8	10	12	14	16	18	20	22	
<b>Straight piece</b> <i>Pièce droite</i>	804201	804202	804203	804203	804205	804206	804206	804206	
<b>Right angle piece</b> <i>Pièce coudée</i>	-	804213	804213	804214	804214	804216	804216	804218	

Note: Heatshrink moulded pieces are not pre-glued.

*Note : Les pièces moulées thermorétractables ne sont pas pré-encollées.*

## Nut ring for square flange receptacle *Contre plaque pour embase à collerette carrée*

Makes panel fixing of square flange receptacle easier by eliminating loose nuts and washers, specially recommended when installation process occurs in reduced volume (compatible with 00 and 02 shell types).

*Facilite la fixation de l'embase à collerette carrée sur le panneau en éliminant l'utilisation des écrous et rondelles; particulièrement recommandé pour une installation dans un volume réduit (compatible avec les types de boîtiers 00 et 02).*

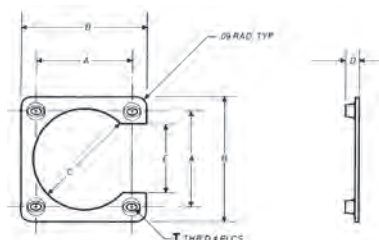

Shell size <i>Taille du boîtier</i>	P/N <i>Référence</i>	T thread <i>Filetage T</i> UNJC-3B	A $\pm 0.02$	B $\pm 0.40$	C $+0.40/-0$	D	E $\pm 0.60$
8	FSU-8	4.40	15.09	22.35	14.07	2.69/4.22	7.82
10	FSU-10	4.40	18.26	25.88	17.48	2.69/4.22	11.00
12	FSU-12	4.40	20.62	27.89	21.03	2.69/4.22	13.36
14	FSU-14	4.40	23.01	30.28	24.21	2.69/4.22	15.75
16	FSU-16	4.40	24.61	31.88	27.79	2.69/4.22	17.35
18	FSU-18	4.40	26.97	34.24	30.10	2.69/4.22	19.71
20	FSU-20	4.40	29.36	38.10	33.15	2.69/4.22	21.97
22	FSU-22	4.40	31.75	40.46	36.27	2.69/4.22	23.04
24	FSU-24	6.32	34.93	44.45	39.62	3.12/4.65	25.40

all dimensions are in mm

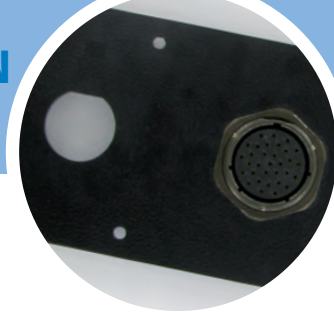

### Panel drilling / Perçage de panneau

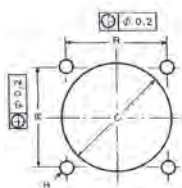

**00 Shell type:**  
rear or front panel mounting  
*Type de boîtier 00 : montage par l'arrière ou l'avant du panneau.*

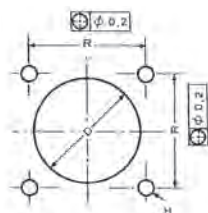

**02 Shell type:**  
front panel mounting  
*Type de boîtier 02 : montage par l'avant du panneau.*

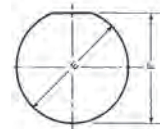

**07 Shell type:**  
rear panel mounting  
*Type de boîtier 07 : montage par l'arrière du panneau.*

**02 Shell type:**  
rear panel mounting.  
*Type de boîtier 02 : montage par l'arrière du panneau.*

Shell size <i>Taille du boîtier</i>	C min.	D +0 -0.3	E +0.3 -0	F +0 -0.3	H	R
8	14.3	13.0	14.5	13.8	3.5	15.10
10	17.3	16.2	17.7	17.0	3.5	18.26
12	21.8	19.4	22.5	21.1	3.5	20.62
14	25.0	22.5	25.6	24.3	3.5	23.01
16	28.1	25.7	28.8	27.5	3.5	24.61
18	31.3	28.9	32.0	30.7	3.5	26.97
20	34.5	32.1	35.2	33.9	3.5	29.36
22	37.7	35.2	38.3	37.1	3.5	31.75
24	40.9	38.4	41.5	40.0	4.0	34.92

### Panel thickness / Épaisseur de panneau

Shell size <i>Taille du boîtier</i>	Square flange receptacle (02) (Rear panel mounting) <i>Embase à collerette carrée (02)</i> (Montage par l'arrière)	Jam nut receptacle (07) <i>Embase à fixation par écrou (07)</i>	
		min.	max.
8	2.5 (max.)	1.6	3.2
10	2.5 (max.)	1.6	3.2
12	2.5 (max.)	1.6	3.2
14	2.5 (max.)	1.6	3.2
16	2.5 (max.)	1.6	3.2
18	2.5 (max.)	1.6	3.2
20	5.6 (max.)	1.6	6.4
22	5.6 (max.)	1.6	6.4
24	5.6 (max.)	1.6	6.4

### Coupling torque value / Couple de serrage

Shell size <i>Taille du boîtier</i>	Torque value max. <i>Couple max.</i> (N.m)	Shell size <i>Taille du boîtier</i>	Torque value <i>Couple</i> (N.m)	Tolerance <i>Tolérance</i> (N.m)
8	2.5	8	4	± 0.5
10	4	10	6	± 0.5
12	5	12	8	± 1
14	7	14	10	± 1
16	9	16	10	± 1
18	10	18	13	± 1
20	11	20	13	± 1
22	12	22	13	± 1
24	13	24	13	± 1

Central jam nut of PT07  
*Écrou central PT07*

Backshell  
*Raccord arrière*

all dimensions are in mm

Printed circuit drillings / *Perçage des circuits imprimés*

On the following drilling layouts the contact identification is viewed mating side of the male connector or cabling side of the female connector. The drillings are symmetrical about the vertical axis of the figure.

The tolerance of the hole positions is 0.1 mm of the theoretical position.

Hole size : - 1 mm (size 20)  
- 1.3 mm (size 16)

Sur les plans de perçage suivants, le repérage des contacts est vu côté enfichage du connecteur mâle ou côté câblage du connecteur femelle. Les perçages sont symétriques par rapport à l'axe vertical de la figure. La tolérance de positionnement des trous est à 0,1 mm de la position théorique.

Diamètre des trous de perçage : - 1 mm (taille 20)  
- 1,3 mm (taille 16)

8-3A

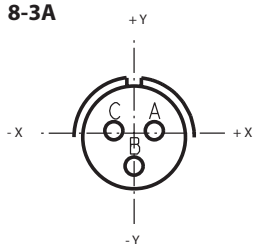

Contact	x (mm)	y (mm)
A	+ 1,65	+ 0,97
B	0	- 1,91
C	- 1,65	+ 0,97

8-4

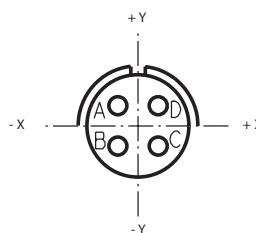

Contact	x (mm)	y (mm)
A	- 1,42	+ 1,42
B	- 1,42	- 1,42
C	+ 1,42	- 1,42
D	+ 1,42	+ 1,42

10-6

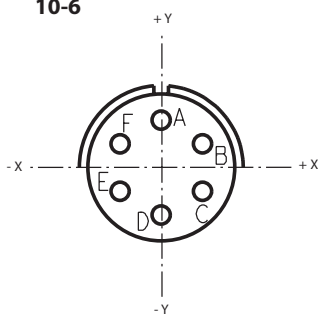

Contact	x (mm)	y (mm)
A	0	+ 3,30
B	+ 2,87	+ 1,65
C	+ 2,87	- 1,65
D	0	- 3,30
E	- 2,87	- 1,65
F	- 2,87	+ 1,65

12-3

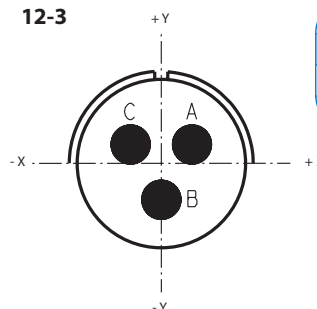

Contact	x (mm)	y (mm)
A	+ 2,39	+ 1,47
B	0	- 2,82
C	- 2,39	+ 1,47

12-10

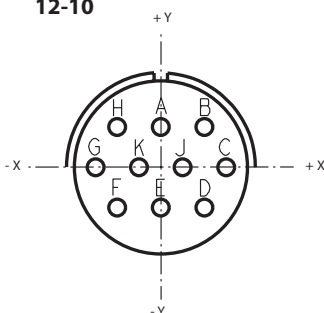

Contact	x (mm)	y (mm)
A	0	+ 3,05
B	+ 3,30	+ 3,05
C	+ 4,95	0
D	+ 3,30	- 3,05
E	0	- 3,05
F	- 3,30	- 3,05
G	- 4,95	0
H	- 3,30	+ 3,05
J	+ 1,65	0
K	- 1,65	0

12-14

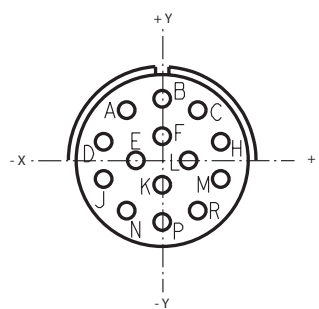

Contact	x (mm)	y (mm)
A	- 2,72	+ 3,84
B	0	+ 4,70
C	+ 2,72	+ 3,84
D	- 4,47	+ 1,42
E	- 2,01	0
F	0	+ 1,85
H	+ 4,47	+ 1,42
J	- 4,47	- 1,42
K	0	- 1,85
L	+ 2,01	0
M	+ 4,47	- 1,42
N	- 2,72	- 3,84
P	0	- 4,70
R	+ 2,72	- 3,84

all dimensions are in mm



14-19

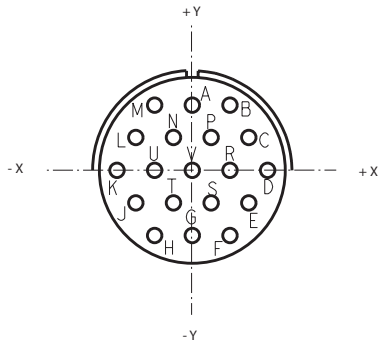

Contact	x (mm)	y (mm)
A	0	+ 5,72
B	+ 3,30	+ 5,72
C	+ 4,95	+ 2,87
D	+ 6,60	0
E	+ 4,95	- 2,87
F	+ 3,30	- 5,72
G	0	- 5,72
H	- 3,30	- 5,72
J	- 4,95	- 2,87

K	- 6,60	0
L	- 4,95	+ 2,87
M	- 3,30	+ 5,72
N	- 1,65	+ 2,87
P	+ 1,65	+ 2,87
R	+ 3,30	0
S	+ 1,65	- 2,87
T	- 1,65	- 2,87
U	- 3,30	0
V	0	0

16-8

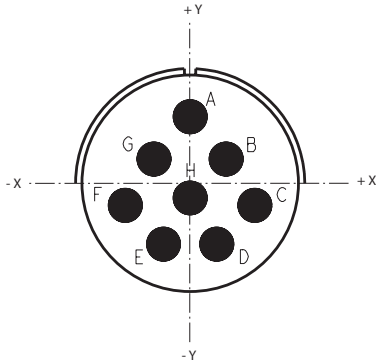

Contact	x (mm)	y (mm)
A	0	+ 5,99
B	+ 3,25	+ 2,18
C	+ 5,84	- 1,98
D	+ 2,39	- 5,49
E	- 2,39	- 5,49
F	- 5,84	- 1,98
G	- 3,25	+ 2,18
H	0	- 1,32

16-26

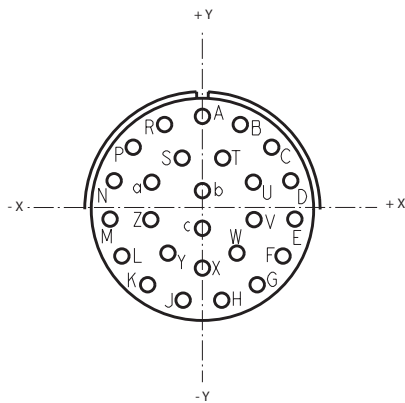

Contact	x (mm)	y (mm)
A	0	+ 8,15
B	+ 3,33	+ 7,44
C	+ 6,07	+ 5,44
D	+ 7,75	+ 2,51
E	+ 8,10	- 0,86
F	+ 7,06	- 4,09
G	+ 4,8	- 6,6
H	+ 1,7	- 7,98
J	- 1,7	- 7,98
K	- 4,8	- 6,6
L	- 7,06	- 4,09
M	- 8,10	- 0,86
N	- 7,75	+ 2,51

P	- 6,07	+ 5,44
R	- 3,33	+ 7,44
S	- 1,78	+ 4,5
T	+ 1,78	+ 4,5
U	+ 4,45	+ 2,39
V	+ 4,52	- 0,91
W	+ 3,02	- 3,84
X	0	- 5,16
Y	- 3,02	- 3,84
Z	- 4,52	- 0,91
a	- 4,45	+ 2,39
b	0	+ 1,65
c	0	- 1,65

18-32

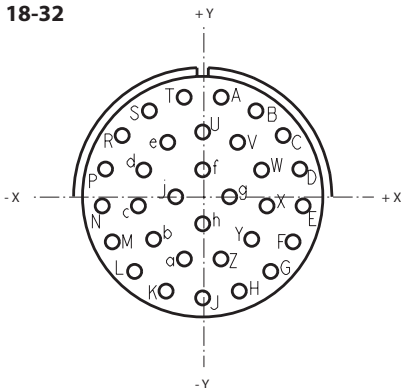

Contact	x (mm)	y (mm)
A	+1,68	+8,97
B	+4,80	+7,75
C	+7,26	+5,51
D	+8,76	+2,49
E	+9,07	-0,84
F	+8,15	-4,06
G	+6,15	-6,73
H	+3,30	-8,51
J	0	-9,12
K	-3,30	-8,51
L	-6,15	-6,73
M	-8,15	-4,06
N	-9,07	-0,84
P	-8,76	+2,49
R	-7,26	+5,51
S	-4,80	+7,75

T	-1,68	+8,97
U	0	+5,84
V	+3,15	+4,90
W	+5,31	+2,41
X	+5,79	-0,84
Y	+4,42	-3,84
Z	+1,65	-5,61
a	-1,65	-5,61
b	-4,42	-3,84
c	-5,79	-0,84
d	-5,31	+2,41
e	-3,15	+4,90
f	0	+2,44
g	+2,44	0
h	0	-2,44
j	-2,44	0

20-41

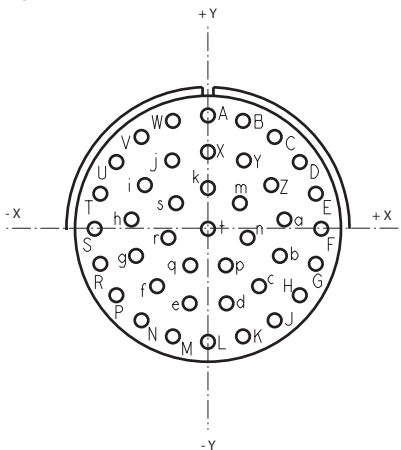

Contact	x (mm)	y (mm)
A	0	+10,6
B	+3,28	+10,09
C	+6,23	+8,58
D	+8,58	+6,23
E	+10,09	+3,28
F	+10,6	0
G	+10,09	-3,28
H	+8,58	-6,23
J	+6,23	-8,58
K	+3,28	-10,09
L	0	-10,6
M	-3,28	-10,09
N	-6,23	-8,58
P	-8,58	-6,23

R	-10,09	-3,28
S	-10,6	0
T	-10,09	+3,28
U	-8,58	+6,23
V	-6,23	+8,58
W	-3,28	+10,09
X	0	+7,20
Y	+3,35	+6,38
Z	+5,92	+4,09
a	+7,15	+0,87
b	+6,73	-2,55
c	+4,78	-5,39
d	+1,73	-6,99
e	-1,73	-6,99

f	-4,78	-5,39
g	-6,73	-2,55
h	-7,15	+0,87
i	-5,92	+4,09
j	-3,35	+6,38
k	0	+3,81
m	+2,98	+2,38
n	+3,71	-0,85
p	+1,66	-3,43
q	-1,66	-3,43
r	-3,71	-0,85
s	-2,98	+2,38
t	0	0

22-55

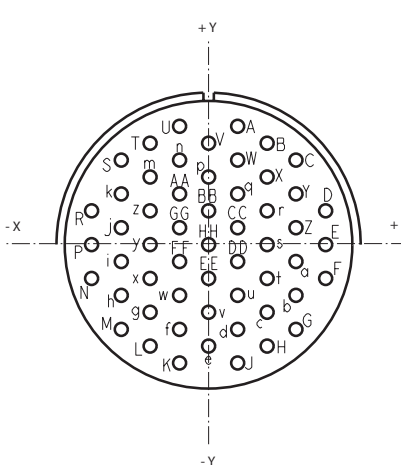

Contact	x (mm)	y (mm)
A	+2,84	+11,56
B	+5,72	+9,91
C	+8,53	+8,26
D	+11,43	+3,30
E	+11,43	0
F	+11,43	-3,30
G	+8,53	-8,26
H	+5,72	-9,91
J	+2,84	-11,56
K	-2,84	-11,56
L	-5,72	-9,91
M	-8,53	-8,26
N	-11,43	-3,30
P	-11,43	0
R	-11,43	+3,30
S	-8,53	+8,26
T	-5,72	+9,91
U	-2,84	+11,56

V	0	+9,91
W	+2,84	+8,26
X	+5,72	+6,60
Y	+8,53	+4,95
Z	+8,53	+1,65
a	+8,53	-1,65
b	+8,53	-4,95
c	+5,72	-6,60
d	+2,84	-8,26
e	0	-9,91
f	-2,84	-8,26
g	-5,72	-6,60
h	-8,53	-4,95
i	-8,53	-1,65
j	-8,53	+1,65
k	-8,53	+4,95
m	-5,72	+6,60
n	-2,84	+8,26
p	0	+6,60

q	+2,84	+4,95
r	+5,72	+3,30
s	+5,72	0
t	+5,72	-3,30
u	+2,84	-4,95
v	0	-6,60
w	-2,84	-4,95
x	-5,72	-3,30
y	-5,72	0
z	-5,72	+3,30
AA	-2,84	+4,95
BB	0	+3,30
CC	+2,84	+1,65
DD	+2,84	-1,65
EE	0	-3,30
FF	-2,84	-1,65
GG	-2,84	+1,65
HH	0	0



### Tools / Outils

Designation Désignation	Amphenol Socapex P/N Référence Amphenol Socapex	Military P/N Référence normalisée
Crimping pliers <i>Pince à sertir</i>	809857	M22520/1-01
Locator for pliers 809857 <i>Positionneur pour pince 809857</i>	809861	M22520/1-02
Metal contact insertion tool for size 20 contact <i>Outil métallique d'insertion pour contact taille 20</i>	809709	-
Metal contact insertion tool for size 16 contact <i>Outil métallique d'insertion pour contact taille 16</i>	809743	-
Metal contact removal tool for size 20 contact (front release) <i>Outil d'extraction métallique pour contact taille 20 (démontage par l'avant)</i>	809710	-
Metal contact removal tool for size 16 contact (front release) <i>Outil d'extraction métallique pour contact taille 16 (démontage par l'avant)</i>	809711	-
Termination of size 20 contact removal tool (spare part) <i>Embout de l'outil d'extraction de contact taille 20 (pièce détachée)</i>	809753	-
Termination of size 16 contact removal tool (spare part) <i>Embout de l'outil d'extraction de contact taille 16 (pièce détachée)</i>	809773	-



Crimping pliers  
*Pince à sertir*





Metal contact insertion tool  
*Outil d'insertion métallique*



Metal contact removal tool  
*Outil d'extraction métallique*

### Tools for rear accessory / Outils pour raccord arrière

Designation Désignation	Amphenol Socapex P/N Référence Amphenol Socapex
Tightening pliers for rear accessories <i>Pince de serrage pour raccord arrière</i>	809720 
Tightening support for plug rear accessories (all sizes dummy receptacles on a chassis) <i>Support de serrage pour fiche avec raccord arrière (toutes les tailles d'embase de repos sur un même châssis)</i>	809717 

## Crimping procedure / *Procédure de sertissage*

Use crimping pliers **M22520/1-01** (Amphenol Socapex P/N: **809857**) and turret **M22520/1-02** (Amphenol Socapex P/N: **809861**). Select the suitable position for your contact by rotating the locator:

- Contact size 20: "red" position
- Contact size 16: "blue" position



*Utiliser la pince à sertir **M22520/1-01** (Ref. Amphenol Socapex : **809857**) et le positionneur **M22520/1-02** (Ref. Amphenol Socapex : **809861**). Placer le positionneur en fonction de la taille du contact utilisé :*

- Contact taille 20 : repère rouge
- Contact taille 16 : repère bleu

Strip the wires carefully to the appropriate length :

- Contact size 20: 5 mm
- Contact size 16: 6 mm

Insert the contact first into the crimp cavity of the tool and then insert the stripped wire into the crimp barrel of the contact. Squeeze the pliers firmly. The handle will not release until the contact is completely crimped.

Ensure that the wire has penetrated correctly by checking that it may be seen through the wire inspection hole of the contact.

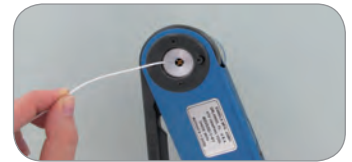

*Dénuder les câbles avec précaution aux longueurs suivantes :*

- Contact taille 20 : 5 mm
- Contact taille 16 : 6 mm

*Insérer en premier le contact dans la cavité de sertissage de l'outil puis insérer le fil dénudé dans le fût de sertissage du contact. Serrez la pince fermement. La pince s'ouvrira d'elle-même dès que le contact sera complètement sertit. Faire un contrôle visuel par le trou d'inspection du contact pour s'assurer que le fil est correctement inséré.*

Use the suitable insertion tool according to the contact size :

- Contact size 20: **809709**
- Contact size 16: **809743**

Slide the tool over the wire side of the contact until the tool bottoms on the contact. Introduce contacts one by one into the rear of the connector pushing straight until the contact snaps into place and the clip ensures contact retention (begin with the center cavity and work outwards in a circular pattern). Every time, remove the tool carefully.

Fill any unused cavities with contacts unwired. A sealing plug can be inserted into the grommet behind the unused contacts to maintain the sealing integrity of the connector.



*Utiliser l'outil d'insertion correspondant à la taille du contact :*

- Contact taille 20 : **809709**
- Contact taille 16 : **809743**

*Glisser l'outil sur la partie cablée du contact, l'extrémité de l'outil prenant appui sur la jupe du contact.*

*Introduire les contacts un par un par l'arrière du connecteur et pousser régulièrement dans l'axe jusqu'à ce que le contact soit maintenu dans la plaquette de rétention (commencer par les cavités du centre et continuer l'opération circulairement). A chaque fois retirer l'outil avec précaution.*

*Afin de maintenir l'étanchéité du connecteur, insérer des contacts non câblés dans les cavités non utilisées puis insérer des obturateurs.*

Check visually the mating face of the connector to insure that all the contacts are on the same plane (fully inserted). Pull lightly on the wire to ensure that the contact is locked securely.



*Faire un contrôle visuel de la face avant du connecteur pour vérifier que tous les contacts sont bien sur un même plan (complètement insérés). Tirer légèrement sur les fils pour vérifier que les contacts sont correctement maintenus.*

## NORTH AMERICA

**Amphenol Pcd, Inc.**  
72 Cherry Hill Drive  
Beverly, MA. 01915 - USA  
Telephone: +1-978-624-3400

## EUROPE

**Amphenol AIR LB**  
10 Rue Champ Raymond  
08110 Carignan - France  
Telephone: +33-3-2422-3270  
Fax: +33-3-2422-387

**Amphenol AIR LB GmbH**  
Am Kleinbahnhof 4 - 66740 Saarlouis - Germany  
Telephone: +49-6831-981-00  
Fax: +49-6831-981-030

**Amphenol BENELUX**  
Zadelmaker 121 NL - 2401 PD Alphen aan den Rijn  
The Netherlands  
Telephone: +31-172-444-903  
Fax: +31-172-240-254

**Amphenol IBERICA**  
Edificio "Burgosol"  
c/Comunidad de Madrid, 35 bis Oficina No 55  
ES - 28230 Las Rozas - Madrid - Spain  
Telephone: +34-91-640-73-02/03/04  
Fax: +34-91-640-73-07

**Amphenol ITALIA**  
Via Barbaiana n.5, 20020 Lainate - Milano - Italy  
Telephone: +39-02-93254-1  
Fax: +39-02-93254-444

**Amphenol LIMITED**  
Thanet Way, Whitstable - Kent, CT5 3JF  
United Kingdom  
Telephone: +44-1227-773-200  
Fax: +44-1227-276-571

**Amphenol MIDDLE & EASTERN EUROPE**  
Wiener gase 68 - 2380 Perchtoldsdorf - Austria  
Telephone: +43-699-10396-071  
Fax: +43-699-40396-071

**SEFEE**  
ZI des Cazes - BP 243  
12403 Saint Affrique - France  
Telephone: +33-5-6598-1100  
Fax: +33-5-6549-3712

**Amphenol SCANDINAVIA**  
Ängsullsvägen 7 - S-187 51 Täby - Sweden  
Telephone: +46-702-12-92-00  
Fax: +46-702-63-46-77

**Amphenol SOCAPEX**  
948 Promenade de l'Arve - BP29  
74311 Thyez Cedex - France  
Telephone: +33-4-5089-2800  
Fax: +33-4-5096-1941

**Amphenol SOUTH EASTERN EUROPE**  
948 Promenade de l'Arve - BP29  
74311 Thyez Cedex - France  
Telephone: +33-4-5089-2840  
Fax: +33-4-5096-1941

## ASIA

**Amphenol DAESHIN**  
558 Sosa, SongNea  
Bucheon-city, Kyunggi-Do  
Korea 420-130  
Telephone: +82-32-610-3800  
Fax: +82-32-673-2507/665-6219

**Amphenol INTERCONNECT INDIA PRIVATE LIMITED**  
105 Bhosari Industrial Area  
Pune 411 026 - India  
Telephone: +91-20-712-0363/0463/0155  
Fax: +91-20-712-0581

**Amphenol JAPAN**  
689-1, Iseochi  
Ritto-shi Shiga 520-3044 - Japan  
Telephone: +81-77-553-8501  
Fax: +81-77-551-2200

**Amphenol PCD CO.LTD**  
2/F Building A5,  
Huafeng Technology Park  
Guan Tian, Bei Huan Road,  
Shi Yan Street  
BaoAn District, Shenzhen,  
China 518132  
Tel: +86-755-8173-8281  
Fax: +86-755-8173-8180

## OTHER AREAS

**Amphenol ARGENTINA**  
Av. Callao 930 2do piso Oficina B "Plaza"  
C1023 - AAP Buenos Aires - Argentina  
Telephone: +54-11-4815-6886  
Fax: +54-11-4814-5779

**Amphenol AUSTRALIA PTY LIMITED**  
2 Fiveways Blvd, Keysborough  
Melbourne, Victoria 3173 - Australia  
Telephone: +61-3-8796-8888  
Fax: +61-3-8796-8801

**BAR TEC LTD**  
4 Hagavish St, PO Box 279  
Kfar Saba 44102 - Israel  
Telephone: +972-9-767-4097  
Fax: +972-9-767-4324

**Amphenol DO BRAZIL**  
Rua Diogo Moreira, 132, 20 andar, rooms 2001-2-3  
CEP: 05423-010 Sao Paulo SP - Brazil  
Telephone: +55-11-3815-1003  
Fax: +55-11-3815-1629

**Amphenol MEXICO**  
Prolongacion Reforma 61 - 6 B2  
Col. Paseo de las Lomas - C.P.013130 - Mexico  
Telephone: +52-55-5258-9984  
Fax: +52-55-5081-6890

**Amphenol RUSSIA**  
8 bldg., 2 Yaroslavskaja Street,  
129164 Moscow - Russia  
Telephone: +7-495-937-6341  
Fax: +7-495-937-6319

**Amphenol SOUTH AFRICA**  
30 Impala Road  
2196 Chislehurst-Sandton - South Africa  
Telephone: +27-11-783-9517  
Fax: +27-11-783-9519

**Amphenol TURKEY**  
Sun Plaza Kat:15  
Maslak Mah. Bilim Sok.No:15  
34398 Şişli - İstanbul  
Telephone: +90-212-367-9220  
Fax: +90-212-367-9221

The information given in this document are as a guideline only. We reserve the right to modify our products in any way we deem necessary. Any duplication is prohibited, unless approved in writing.

Les renseignements figurent dans ce document à titre d'information uniquement. Nous nous réservons le droit de modifier nos produits si nous le jugeons nécessaire. Toute reproduction est interdite sauf si elle a d'abord été autorisée par écrit par nos services.

# Amphenol

Amphenol Socapex • Mil/Aero & Industrial Business Unit  
948, Promenade de l'Arve - BP 29 • F - 74311 Thyez Cedex  
Tel: +33 (0) 4 50 89 28 00 • Fax: +33 (0) 4 50 96 19 41  
<http://www.amphenol-socapex.com>

Design by [shinylab.com](http://shinylab.com) • March 2010  
Gestion & Edition by AMPHENOL & COMALYON

Your local Contact:

E120/G



For more information, please visit our website:  
<http://www.451-connectors.com>