



SinglFuse™ SF-1206SPxxxM Series Features

- Single blow fuse for overcurrent protection
- 3216 (EIA 1206) footprint
- Time Lag fuse
- UL 248-14 listed
- RoHS compliant* and halogen free**
- Multilayer SMD design
- Surface mount packaging for automated assembly

SF-1206SPxxxM Series - Time Lag Multilayer Surface Mount Fuses

Electrical Characteristics

| Model | Rated Current (Amps) | Fusing Time | Resistance (Ω) Typ.*** | Rated Voltage | Interrupting Rating | Typical I ² t (A ² s) **** | |
|-----------------|----------------------|---|------------------------|---------------|---------------------|--|------|
| SF-1206SP100M-2 | 1.00 | Open within 120 sec. at 200 % rated current | 0.360 | DC 63 V | DC 63 V 50 A | 0.11 | |
| SF-1206SP125M-2 | 1.25 | | 0.200 | | | 0.22 | |
| SF-1206SP150M-2 | 1.50 | | 0.150 | | | 0.23 | |
| SF-1206SP200M-2 | 2.00 | | 0.088 | | | 0.63 | |
| SF-1206SP250M-2 | 2.50 | | 0.065 | DC 32V | DC 32 V 50 A | 0.90 | |
| SF-1206SP300M-2 | 3.00 | | 0.034 | | | 1.20 | |
| SF-1206SP350M-2 | 3.50 | | 0.028 | | | 1.60 | |
| SF-1206SP400M-2 | 4.00 | | 0.024 | | | 2.20 | |
| SF-1206SP450M-2 | 4.50 | | 0.020 | | | 3.60 | |
| SF-1206SP500M-2 | 5.00 | | 0.018 | | | 5.30 | |
| SF-1206SP550M-2 | 5.50 | | 0.014 | DC 24V | DC 24 V 50 A | 6.40 | |
| SF-1206SP600M-2 | 6.00 | | 0.011 | | | DV 24 V 60 A | 8.50 |
| SF-1206SP700M-2 | 7.00 | | 0.010 | | | | 10.0 |
| SF-1206SP800M-2 | 8.00 | | 0.009 | | | | 16.9 |

*** Resistance value measured with ≤10 % rated current at 25 °C ambient.

**** Melting I²t calculated at 0.001 second pre-arcing time.

Reliability Testing

| No. | Test | Requirement | Test Condition | Test Reference |
|-----|---------------------------|---|---|---------------------------|
| 1 | Soldering heat resistance | DCR change ≤ ±10 % No mechanical damage | One dip at 260 °C for 60 seconds | MIL-STD-202 Method 210 |
| 2 | Solderability | Minimum 95 % coverage | One dip at 245 °C for 5 seconds | MIL-STD-202 Method 208 |
| 3 | Thermal shock | DCR change ≤ ±10 % No mechanical damage | 100 cycles between -65 °C and +125 °C | MIL-STD-202 Method 107 |
| 4 | Moisture resistance | DCR change ≤ ±15 % No excessive corrosion | 10 cycles | MIL-STD-202 Method 106 |
| 5 | Salt spray | DCR change ≤ ±10 % No excessive corrosion | 48 hour exposure, 5 % salt solution | MIL-STD-202 Method 101 |
| 6 | Mechanical vibration | DCR change ≤ ±10 % No mechanical damage | 0.4 inch D.A. or 30 G between 5-3000 Hz | MIL-STD-202 Method 204 |
| 7 | Mechanical shock | DCR change ≤ ±10 % No mechanical damage | 1500 G, 0.5 ms, half-sine shocks | MIL-STD-202 Method 213 |
| 8 | Life | No electrical "opens" during testing Voltage drop change shall be less than ±20 % of initial value | 80 % rated current (75 % for < 1 A fuses) for 2000 hours at ambient temperature between +20 °C and +30 °C | Refer to STP document |

Agency Recognition

UL File Number E198545

<http://www.ul.com/> Follow link to Online Certificates Directory, then enter UL File No. E198545, or [click here](#)

BOURNS®

Asia-Pacific: Tel: +886-2 2562-4117 • Email: asiacus@bourns.com

EMEA: Tel: +36 88 520 390 • Email: eurocus@bourns.com

The Americas: Tel: +1-951 781-5500 • Email: americus@bourns.com

www.bourns.com

* RoHS Directive 2002/95/EC Jan. 27, 2003 including annex and RoHS Recast 2011/65/EU June 8, 2011.

** Bourns considers a product to be "halogen free" if (a) the Bromine (Br) content is 900 ppm or less; (b) the Chlorine (Cl) content is 900 ppm or less; and (c) the total Bromine (Br) and Chlorine (Cl) content is 1500 ppm or less.

"SinglFuse" is a trademark of Bourns, Inc.

Specifications are subject to change without notice.

The device characteristics and parameters in this data sheet can and do vary in different applications and actual device performance may vary over time.

Users should verify actual device performance in their specific applications.

SingIFuse™ SF-1206SPxxxM Series Applications

- Portable memory
- LCD monitors
- Disk drives
- PDAs
- Digital cameras
- MP3 players
- Cell phones
- Rechargeable battery packs
- Battery chargers
- Set-top boxes
- Industrial controllers
- Battery Management Systems (BMS)
- LED lighting
- Power tools

SF-1206SPxxxM Series - Time Lag Multilayer Surface Mount Fuses BOURNS®

Environmental Characteristics

| | |
|---------------------------------|---------------------------------|
| Operating Temperature..... | -55 °C to +150 °C |
| Storage Conditions | |
| Temperature | +5 °C to +35 °C |
| Humidity..... | 40 % to 75 % |
| Shelf Life..... | 2 years from manufacturing date |
| Moisture Sensitivity Level..... | 1 |
| ESD Classification (HBM)..... | Class 6 |

Typical Part Marking

Represents total content. Layout may vary.



RATED CURRENT (A)

| | |
|----------|----------|
| E = 1.00 | M = 4.00 |
| F = 1.25 | T = 4.50 |
| G = 1.50 | N = 5.00 |
| I = 2.00 | U = 5.50 |
| J = 2.50 | O = 6.00 |
| K = 3.00 | P = 7.00 |
| L = 3.50 | R = 8.00 |

How to Order

SF - 1206 SP 100 M - 2

SingIFuse™
 Product Designator
 SMD Footprint
 1206 = 3216 (EIA 1206) size
 Fuse Blow Type
 SP = Time Lag
 Rated Current
 100 ~ 800 (1.00 A ~ 8.00 A)
 Structure Type
 M = Multilayer
 Packaging Type
 - 2 = Tape & Reel

Construction

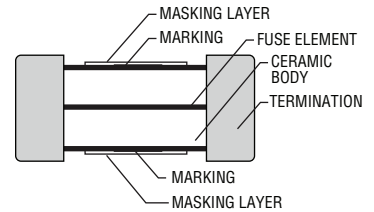

Packaging Quantity

3,000 pieces per 7-inch reel

Product Dimensions

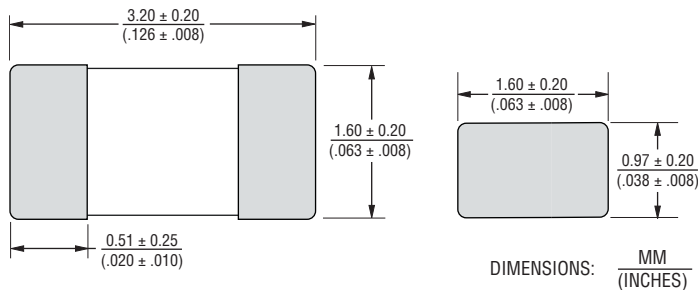

Recommended Pad Layout

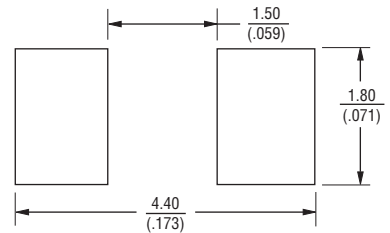

Current Rating Thermal Derating Curve

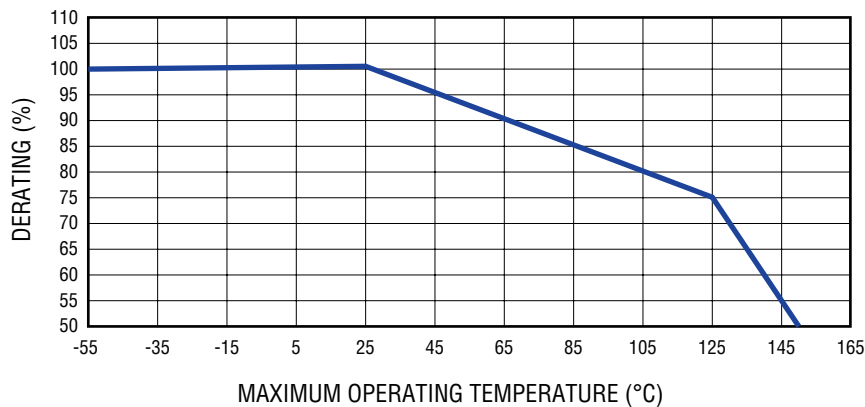

Specifications are subject to change without notice. The device characteristics and parameters in this data sheet can and do vary in different applications and actual device performance may vary over time. Users should verify actual device performance in their specific applications.

Solder Reflow Recommendations



| Profile Feature | Pb-Free Assembly |
|---|------------------------------------|
| Preheat / Soak: Temperature Min. (T_{smin}) Temperature Max. (T_{smax}) Time (t_s) from (T_{smin} to T_{smax}) | 150 °C 200 °C 60~120 seconds |
| Ramp Up Rate (T_l to T_d) | 3 °C / second max. |
| Liquidous Temperature (T_l) Time (t_L) maintained above T_l | 217 °C 60~150 seconds |
| Peak Package Body Temperature (T_d) | 260 °C |
| Time (t_p)* within 5 °C of the specified classification temperature (T_c) | 30 seconds* |
| Ramp Down Rate (T_d to T_l) | 6 °C / second max. |
| Time 25 °C to Peak Temperature | 8 minutes max. |

* Tolerance for peak profile temperature (T_p) is defined as a supplier minimum and a user maximum.

Recommended Temperature Profile for Wave Soldering



Wave soldering is suitable for 1206 size models.

Average Pre-Arcing Time vs. Current Curves

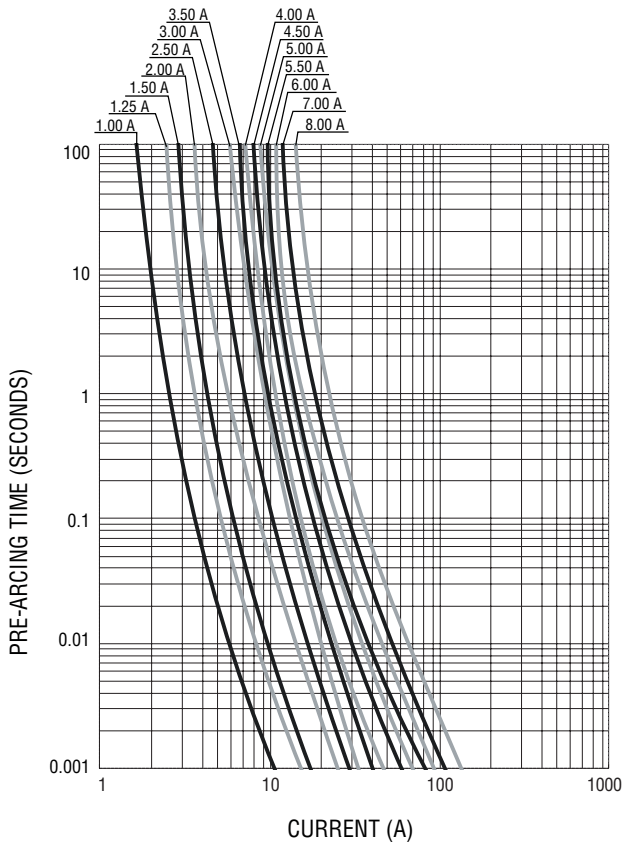

Average I^2t vs. t Curves

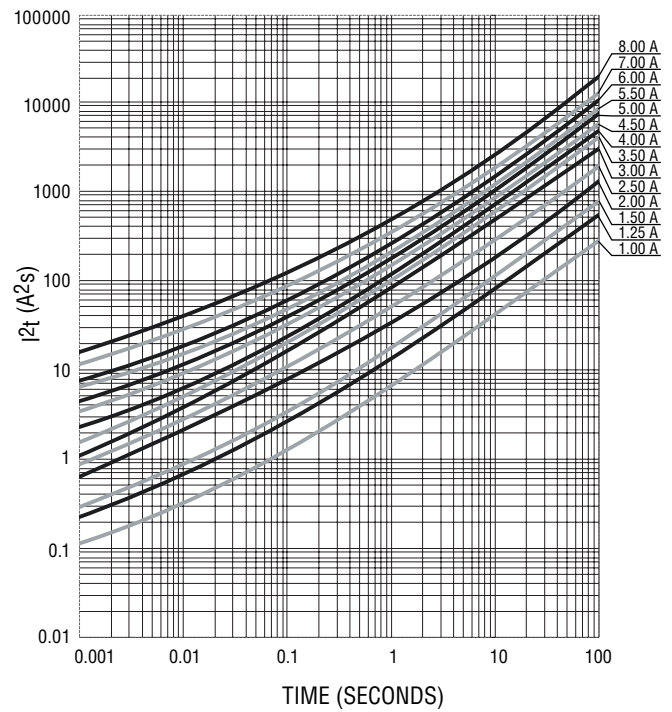

SF-1206SPxxxM Series Tape and Reel Packaging Specifications

BOURNS®

SF-1206SPxxxM Series per EIA 481-2

Tape Dimensions

| | |
|----------------|---|
| W | $\frac{8.00 \pm 0.10}{(.315 \pm .004)}$ |
| P ₀ | $\frac{4.0 \pm 0.10}{(.157 \pm .004)}$ |
| P ₁ | $\frac{4.0 \pm 0.10}{(.157 \pm .004)}$ |
| P ₂ | $\frac{2.0 \pm 0.05}{(.079 \pm .002)}$ |
| A ₀ | $\frac{1.80 \pm 0.10}{(.071 \pm .004)}$ |
| B ₀ | $\frac{3.50 \pm 0.10}{(.138 \pm .004)}$ |
| F | $\frac{3.50 \pm 0.05}{(.138 \pm .002)}$ |
| E ₁ | $\frac{1.75 \pm 0.10}{(.069 \pm .004)}$ |
| D ₀ | $\frac{1.50 \pm 0.10}{(.059 \pm .004)}$ |
| K ₀ | $\frac{1.10 \pm 0.10}{(.043 \pm .004)}$ |
| T | $\frac{0.23 \pm 0.02}{(.009 \pm .001)}$ |

PACKAGING: Plastic tape, 3,000 pcs. per reel

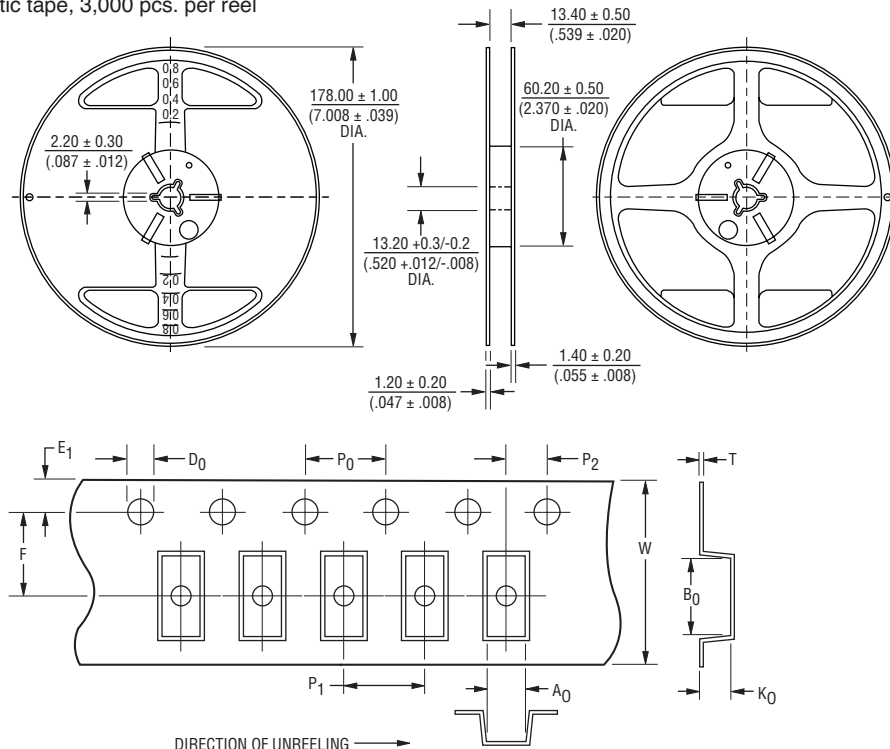

DIMENSIONS: $\frac{\text{MM}}{(\text{INCHES})}$

Specifications are subject to change without notice.

The device characteristics and parameters in this data sheet can and do vary in different applications and actual device performance may vary over time. Users should verify actual device performance in their specific applications.