

# i-PRO

# WV-U61300-ZY WV-U61300-ZYG

## U series PTZ camera

# 2MP (1080p) 3.1x Indoor PTZ Network Camera

U-Series launch gives customers PTZ's that meet top security certifications (FIPS 140-2 level 3) while also providing a unique blend of imaging performance, reliability and affordability.

### Highly durable pan-tilt drive unit Reduced maintenance costs

- PAN,TILT drive endurance (1 million movements) to reduce maintenance frequency.

### Easy installation

- U-series compact PTZ cameras can be installed discreetly and easily on low ceilings.
- Easy kitting packaging allows the camera to be set up without removing it from the box during kitting prior to installation.
- The addition of a diverse lineup of mounting brackets and optional PoE injectors enables flexible installation regardless of the location of new or existing installations.

### High security standard

- Highest level of security. In addition to digital certificates issued by a third-party organization (GlobalSign®), FIPS 140-2 level3-certified hardware is installed.

### Key i-PRO Spec.

- 2MP (1080p) 1920x1080
- 3.1x optical zoom
- Intelligent Auto
- Super Dynamic 144dB
- Color night vision (0.001 to 0.01 lx) (G : 0.002 to 0.03 lx)
- ONVIF® Profile G / S / T \*ONVIF is a trademark of ONVIF, Inc.
- FIPS 140-2 level3 certified

### Industry examples

- Retail (Shopping mall) / Logistics
- Transportation (Airport / Train, Subway station)
- Bank
- Building



WV-U61300-ZY



WV-U61300-ZYG (Smoke Dome)



## Specifications

<b>Camera</b>	Image Sensor	Approx. 1/2.8 type CMOS image sensor	
	Minimum Illumination	Color : 0.01 lx (G: 0.03 lx) (50IRE, F1.3, 1/30s) Color : 0.001 lx (G: 0.002 lx) (50IRE, F1.3, 16/30s)*1 BW : 0.004 lx (G: 0.012 lx) (50IRE, F1.3, 1/30s) BW : 0.0003 lx (G: 0.0008 lx) (50IRE, F1.3, 16/30s)	
	White Balance	ATW1 / ATW2 / AWC	
	Shutter Speed	[60 fps Mode] 1/60 Fix to 1/10000 Fix, [30 fps/15 fps mode] 1/30 Fix to 1/10000 Fix [50 fps Mode] 1/50 Fix to 1/10000 Fix, [25 fps/12.5 fps mode] 1/25 Fix to 1/10000 Fix	
	Intelligent Auto	On / Off	
	Super Dynamic*2	On / Off, The level can be set in the range of 0 to 31.	
	Dynamic Range	Max.144 dB (Super Dynamic : On, Level 31)	
	Adaptive Black Stretch	The level can be set in the range of 0 to 255.	
	Back light compensation / High light compensation	BLC (Back light compensation) / HLC (High light compensation) / Off The level can be set in the range of 0 to 31 (only when Super dynamic / Intelligent Auto : Off)	
	Fog compensation	On / Off, The level can be set in the range of 0 to 8 (only when intelligent auto / auto contrast adjust : Off)	
	Maximum gain (AGC)	The level can be set in the range of 0 to 11.	
	Color/BW (ICR)	Off / On / Auto1 / Auto2 / Auto3 (SCC)	
	Digital Noise Reduction	The level can be set in the range of 0 to 255.	
	Video Motion Detection (VMD)	On / Off, 4 areas available	
	Scene Change Detection (SCD)	On / Off, 1 areas available	
	Audio Detection	On / Off	
	AI Sound Classification	—	
	AI Analytics	—	
	Privacy Zone	On / Off, Up to 32 zones available	
	VIQS	On / Off, Up to 8 zones available	
Camera Title (OSD)	On / Off, Up to 40 characters (alphanumeric characters, marks)		
Focus Adjustment	Auto focus		
<b>Lens</b>	Optical zoom	3.1x (Motorized zoom / Motorized Focus)	
	Extra zoom	Max. 4x (3.1 to 4x : When resolution is 1280 x 720)	
	Focal length	2.9 - 9 mm [1/8 inches - 11/32 inches]	
	Angular Field of View	[16 : 9 mode] Horizontal : 36° (TELE) - 115° (WIDE), Vertical : 20° (TELE) - 61° (WIDE) [4 : 3 mode] Horizontal : 28° (TELE) - 82° (WIDE), Vertical : 20° (TELE) - 61° (WIDE)	
Maximum Aperture Ratio	1 : 1.3 (WIDE) - 1 : 2.5 (TELE)		
Focus range	0.3 m (11-13/16 inches) - ∞		
<b>DORI</b>	Detect (25ppm / 8ppf)	Wide: 25.4 m / 83.4 ft, Tele: 118.2 m / 387.7 ft	
	Observe (62.5ppm / 19ppf)	Wide: 10.2 m / 33.4 ft, Tele: 47.3 m / 155.1 ft	
	Recognize (125ppm / 38ppf)	Wide: 5.1 m / 16.7 ft, Tele: 23.6 m / 77.5 ft	
	Identify (250ppm / 76ppf)	Wide: 2.5 m / 8.3 ft, Tele: 11.8 m / 38.8 ft	
<b>System on Chip (SoC)</b>	Ambarella CV25M		
<b>Adjusting Angle</b>	Horizontal : 0 to +350°, Vertical : 0 to +90°, Yaw : 0°		
<b>Pan/tilt</b>	Panning Range	0 - +350°	
	Panning Speed	Manual: Approx. 0.065°/s - 150°/s Preset: Up to approx. 150°/s	
	Tilting Range	Operational 0 - +90°	
	Tilting Speed	Manual: Approx. 0.065°/s - 150°/s Preset: Up to approx. 150°/s	
	Preset Positions	256 positions	
<b>Browser GUI</b>	Auto Mode	Auto pan/ Preset sequence/ Patrol	
	Self Return	10 s/ 20 s/ 30 s/ 1 min/ 2 min/ 3 min/ 5 min/ 10 min/ 20 min/ 30 min/ 60 min	
	Camera Control	Brightness, AUX On / Off	
	Audio	Mic (Line) Input : On / Off Volume adjustment : Low / Middle / High Audio Output : On / Off Volume adjustment : Low / Middle / High	
<b>Network</b>	GUI / Setup Menu Language	English, Italian, French, German, Spanish, Portuguese, Russian, Chinese, Japanese Browser*3	
	Microsoft Edge, Firefox, Google Chrome		
<b>Network</b>	Network IF	10Base-T / 100Base-TX, RJ45 connector	
	Resolution	[16 : 9 mode (60 fps mode)]*2, [16 : 9 mode (30 fps mode)], [16 : 9 mode (50 fps mode)]*2, [16 : 9 mode (25 fps mode)] 1920x1080, 1280x720, 640x360, 320x180	
	H.265/ H.264 / JPEG (MJPEG)	[4 : 3 mode (30 fps mode)], [4 : 3 mode (25 fps mode)] 1280x960, VGA, QVGA [4 : 3 mode (15 fps mode)], [4 : 3 mode (12.5 fps mode)] 2048x1536*4, 1280x960, VGA, QVGA	
	H.265/ H.264*5 JPEG	Transmission Mode	Constant bit rate / VBR / Frame rate / Best effort
	Transmission Type	Unicast port (AUTO) / Unicast port (MANUAL) / Multicast	
	Image Quality	10 steps	

<b>Network</b>	Smart Coding	<b>GOP (Group of pictures) control:</b> Off/ Low (Variable GOP 1s-8s) / Mid (Variable GOP 4s-16s) / Advanced (Fixed GOP 60s w/1s key-frame) / Frame rate control (Variable GOP 4s-16s with frame rate control) *Advanced and Frame rate control are only available with H.265. <b>Smart Coding: Auto VIQS: On/Off</b>
	Audio Compression	G.726 (ADPCM) : 16 kbps / 32 kbps G.711 : 64 kbps AAC-LC*6 : 64 kbps / 96 kbps / 128 kbps
<b>Audio transmission mode</b>	Supported Protocol	Off / Mic (Line) input / Audio output / Interactive (Half duplex) / Interactive (Full duplex)
	Supported Protocol	IPv6 : TCP/IP, UDP/IP, HTTP, HTTPS, SSL/TLS, SMTP, DNS, NTP, SNMPv1/v2/v3, DHCPv6, RTP, MLD, ICMP, ARP, IEEE 802.1X, DiffServ IPv4 : TCP/IP, UDP/IP, HTTP, HTTPS, SSL/TLS, RTP, RTSP, RTP, RTCP, SMTP, DHCP, DNS, DDNS, NTP, SNMPv1/v2/v3, UPnP, IGMP, ICMP, ARP, IEEE 802.1X, DiffServ, SRTP, MQTT, NTCP
<b>Secure</b>	No. of Simultaneous Users	Up to 14 users (Depends on network conditions)
	Secure	FIPS 140-2 level3, Device Certificate GlobalSign® pre-installed
<b>Memory Card</b>	SDXC/SDHC/SD	H.265 / H.264 recording : Manual REC / Alarm REC (Pre/Post) / Schedule REC / Backup upon network failure
	JPEG recording :	Manual REC / Alarm REC (Pre/Post) / Backup upon network failure
<b>Mobile Terminal Compatibility</b>	Compatible SDXC/SDHC/SD Memory Card :	Compatible SDXC memory card : 64 GB, 128 GB, 256 GB, 512 GB microSDHC memory card : 4 GB, 8 GB, 16 GB, 32 GB microSD memory card : 2 GB
	Compatible SDXC/SDHC/SD Memory Card :	microSD memory card : 2 GB
<b>Alarm</b>	Mobile Terminal Compatibility	iPad, iPhone (iOS 8.0 or later), Android™ terminals
	ONVIF® Profile	G / S / T
<b>Input/Output</b>	Alarm Source	3 terminals input, VMD alarm, Command alarm, Audio detection alarm
	Alarm Actions	SDXC/SDHC/SD memory recording, E-mail notification, HTTP alarm notification Indication on browser, TCP alarm notification output
<b>General</b>	Audio input	Ø3.5 mm stereo mini jack For microphone input : Recommended applicable microphone : Plug-in power type (Sensitivity of microphone : -51 dB to -38 dB (0 dB=1V/Pa, 1 kHz)) Input impedance : Approx. 2 kΩ (unbalanced) Supply voltage : 2.5 V ±0.5 V
	Audio Output	For line input : Input level : Approx. -10 dBV Ø3.5 mm stereo mini jack (monaural output) Output impedance : Approx. 600 Ω (unbalanced) Output level : -20 dBV
<b>External I/O Terminals</b>	External I/O Terminals	ALARM IN 1 (Alarm input 1/ Black & white input/ Auto time adjustment input) (x1) ALARM IN 2 (Alarm input 2/ ALARM OUT) (x1), ALARM IN 3 (Alarm input 3/ AUX OUT) (x1)
	Safety	UL (UL62368-1), c-UL (CSA C22.2 No.62368-1), CE, IEC62368-1
<b>EMC</b>	Power Source and Power Consumption	FCC (Part15 ClassA), ICES-003 Issue 7 ClassA, EN55032 ClassA, EN55035 DC12 V, PoE (IEEE802.3af) DC12 V: 890 mA / Approx. 10.7 W PoE DC 48 V: 250 mA / Approx.12.0 W (Class 0 device)
	Ambient Operating Temperature	-10 °C to +50 °C (+14 °F to +122 °F) (Power On range : 0 °C to +50 °C (+32 °F to +122 °F))
<b>Anti-Condensation System</b>	Ambient Operating Humidity	10 to 90 % (no condensation)
	Dimensions	Ø131 mm x 128 mm (H) (Ø5-5/32 inches x 5-1/32 inches (H))
<b>Mass (approx.)</b>	Mass (approx.)	Approx. 0.8 kg (1.76 lbs.)
	Finish	Main body : Resin, i-PRO white Dome section : polycarbonate resin, Clear (G: Smoke)

- \*1 Converted value
- \*2 When 60 fps or 50 fps is selected, the Super Dynamic function is automatically set to off.
- \*3 For information on the operation verification of the supported web browsers, refer to our support website <Control No. C0132>.
- \*4 Used by super resolution techniques
- \*5 Transmission for 4 streams can be individually set.
- \*6 When recording audio on an microSD memory card, only use AAC-LC (Advanced Audio Coding - Low Complexity).



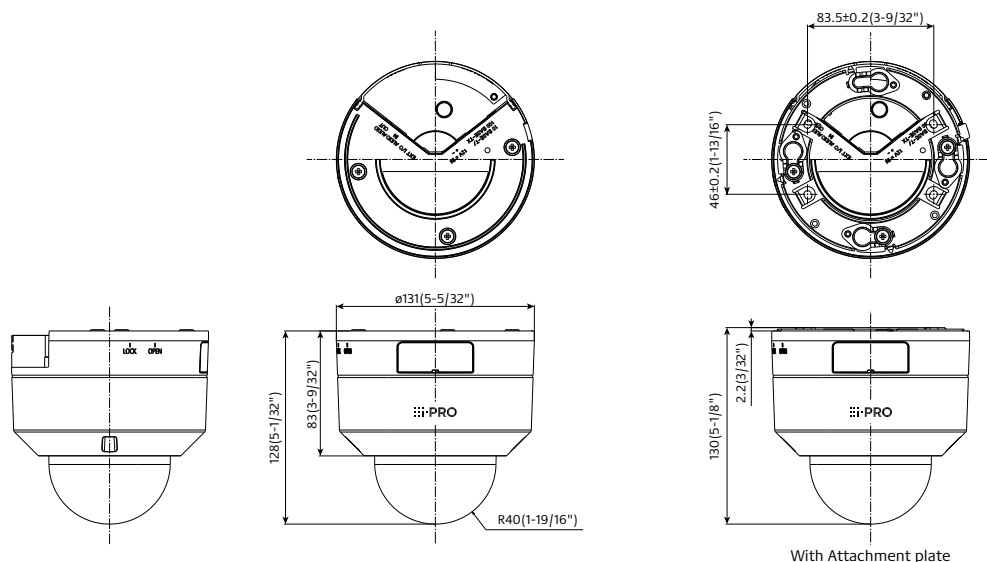









## Appearance









Unit : mm (inches)

## Optional Accessories

### Mount Bracket / Other

	WALL		POLE	CORNER	HANGING	
	1	2	1	1	1	2
combination	Wall Mount Bracket <b>WV-QWL501-W</b> (i-PRO white) 	Wall Mount Bracket <b>WV-QWL500-W</b> (i-PRO white) 	Pole Mount Bracket <b>WV-QPL500-W</b> (i-PRO white) 	Corner Mount Bracket <b>WV-QCN500-W</b> (i-PRO white) 	Ceiling Mount Bracket <b>WV-QCL501-W</b> (i-PRO white) 	Ceiling Mount Bracket <b>WV-QCL100-W</b> *1 (i-PRO white)  <small>*For indoor installation only.</small>
	Mount Bracket <b>WV-QSR501-W</b> (i-PRO white) 	Adapter Box <b>WV-QJB500-W</b> (i-PRO white)  <small>*if needed.</small>	Wall Mount Bracket <b>WV-QWL501-W</b> (i-PRO white) 	Wall Mount Bracket <b>WV-QWL501-W</b> (i-PRO white) 	Mount Bracket <b>WV-QSR501-W</b> (i-PRO white) 	
			Mount Bracket <b>WV-QSR501-W</b> (i-PRO white) 	Mount Bracket <b>WV-QSR501-W</b> (i-PRO white) 		

\*1: It's possible to be used on the camera side and ceiling side. If used on both side, 2pieces are required.

	CEILING			OTHER
	1	2	3	1
combination	Base Bracket <b>WV-QJB501-W</b> (i-PRO white) 	Ceiling Mount Bracket (Embedded) <b>WV-QEM501-W</b> (i-PRO white)  <small>*For indoor installation only.</small>	Base bracket <b>WV-QJB504-W</b> (i-PRO white) 	3rd Party Pipe (Male or Female type)
				Mount Bracket <b>WV-QSR501F-W</b> (i-PRO white, ISO Female thread)  <b>WV-QSR501M-W</b> (i-PRO white, ISO Male thread) 
				Mount Bracket <b>WV-QSR501F1-W</b> (White, ANSI Female thread)  <b>WV-QSR501M1-W</b> (White, ANSI Male thread) 

### Dome Cover

Dome Cover (Smoke type)  
**WV-CF5S**



#### Trademarks and registered trademarks

- GlobalSign and the GlobalSign Logo are registered trademarks of GMO GlobalSign K.K.
- iPad and iPhone are trademarks of Apple Inc., registered in the U.S. and other countries.
- Android is a trademark of Google LLC.
- ONVIF is a trademark of ONVIF, Inc.
- All other trademarks identified herein are the property of their respective owners.

#### Important

- Safety Precautions : Carefully read the Basic Information, Installation Guide and Operating Instructions before using this product.
- i-PRO Co., Ltd. cannot be held responsible for the performance of the network and/or other manufacturers' products used on the network.
- Masses and dimensions are approximate. • Specifications are subject to change without notice.