

BD2-AK05/FS400IEC-3 TAP-OFF UNIT 320A / 1X 3  
POLE WITH IEC FUSE SWITCH

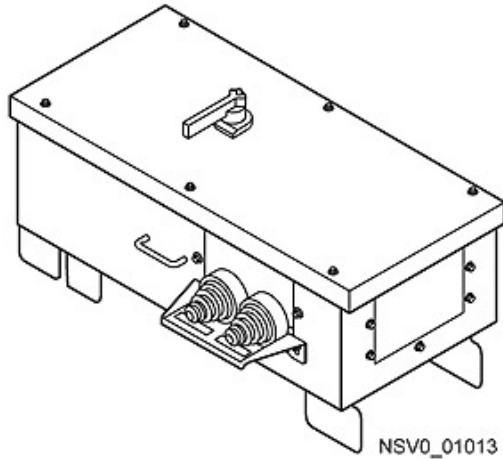

Model		
Product designation		tap-off unit for BD2 busbar trunking system
Protection class		
Protection class IP		IP54
Main circuit		
<b>Operating frequency / Rated value</b>		
• minimum	Hz	50
• maximum	Hz	60
<b>Operating voltage / with AC</b>		
• at 50 Hz / Rated value / maximum	V	400
• at 60 Hz / Rated value / maximum	V	400
<b>Operating current</b>		
• for circuit 1 / with AC / at 50 Hz / Rated value / maximum	A	320
• for circuit 1 / with AC / at 60 Hz / Rated value / maximum	A	320
Connections		
Connectable conductor cross-section / in the outgoing unit		
• minimum	mm <sup>2</sup>	10
• maximum	mm <sup>2</sup>	120
Tap-off points		
Outgoing unit version		cable entry

Design of short-circuit and overloading protection / in the outgoing unit		3-pole 400 A fuse-switch
Size of the outgoing feeder		05
Number of poles / of the outgoing feeder		5

#### Mechanical Design

Height	mm	408
Width	mm	494
Length	mm	924
Product component / Locking mechanism		Yes

#### General Product Approval



#### Further information

**Information- and Downloadcenter (Catalogs, Brochures,...)**

<http://www.siemens.com/lowvoltage/catalogs>

**Industry Mall (Online ordering system)**

<https://eb.automation.siemens.com/mall/en/WW/Catalog/Product/BVP:610413>

**Service&Support (Manuals, Certificates, Characteristics, FAQs,...)**

<http://support.automation.siemens.com/WW/view/en/BVP:610413/all>

**Image database (product images, 2D dimension drawings, 3D models, device circuit diagrams, ...)**

[http://www.automation.siemens.com/bilddb/cax\\_en.aspx?mlfb=BVP:610413](http://www.automation.siemens.com/bilddb/cax_en.aspx?mlfb=BVP:610413)

**CAX-Online-Generator**

<http://www.siemens.com/cax>

**Tender specifications**

<http://ausschreibungstexte.siemens.com/tiplv>

last modified:

11.03.2015