

03

KV ... C

Circular connectors with threaded joint M16 acc. to IEC 61076-2-106, IP40/IP68



Socket acc. to IEC 61076-2-106, IP40, straight version, with threaded joint, empty housing for reception of crimp contacts, with bend protection, for cable diameter up to 6 mm

03

KV ... C

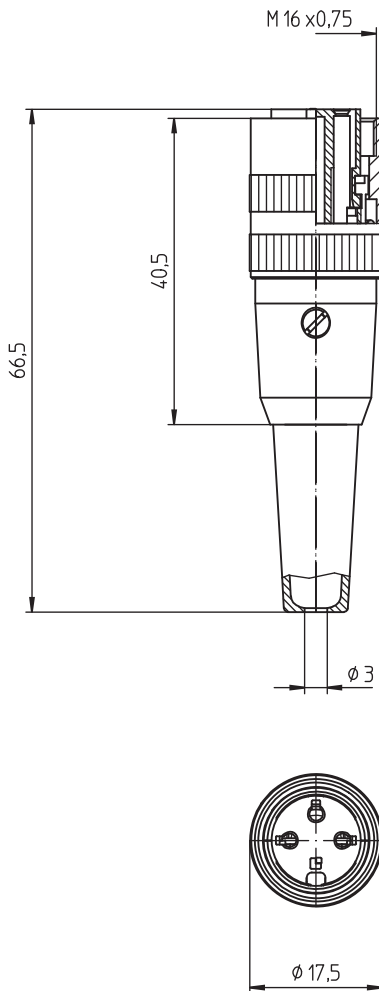

Environmental conditions

Temperature range -40 °C/+85 °C

Materials

Insulating body	PA GF, V-0 according to UL94
Sleeve	PC, HB according to UL94
Strain relief	steel, nickel-plated
Housing	CuZn, nickel-plated
Knurled nut	CuZn, nickel-plated
Bend protection sleeve	TPE
Screw	steel, nickel-plated

Mechanical data

Tightening torque connector 1–3 Nm

Protection class IP40¹

¹ according to IEC DIN EN 60529, only in locked condition with an appropriate counterpart

Connectable conductors for crimp area

Cable diameter 4–6 mm

Electrical data (at T_{amb} 20 °C)

Contact resistance	≤ 5 mΩ
Rated current	5 A (T _{amb} 40 °C)
Rated voltage	with pollution degree 1: 300 V (versions 30, 40, 50/6, 60, 70) 100 V (versions 50, 71, 80, 81) with pollution degree 2: 250 V (versions 30, 40) 32 V (versions 50, 71, 80, 81) 160 V (versions 50/6, 60, 70)
Rated impulse voltage	1500 V (versions 30, 40, 50/6, 60, 70) 500 V (versions 50, 71, 80, 81)
Material group	II (IEC)/I (UL) (400 ≤ CTI < 600)
Overvoltage category	I
Insulation resistance	> 100 MΩ

Associated products

Counterparts

☞ SFV	☞ SFV	☞ SFV ... C
☞ SGR	☞ SGR	☞ SGV
☞ SGV	☞ SGV ... C	☞ SV
☞ SV	☞ SV ... C	☞ SV ...-8

Pin configurations, crimp side view



03-a
KV 30 C

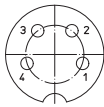

04-a
KV 40 C

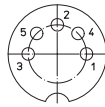

05-b
KV 50 C

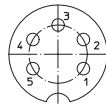

05-a
KV 50/6 C

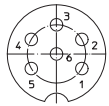

06-a
KV 60 C

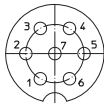

07-a
KV 70 C

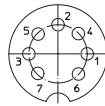

07-b
KV 71 C

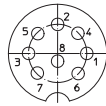

08-a
KV 81 C

☞ SV ...-8
☞ WSV ... C

☞ SV ...-8 C

☞ WSV

Accessories

☞ 0364
☞ 038799

☞ 0381

☞ 038199

03

KV ... C

Designation	Pole Number	PU (Pieces)	MDQ (Pieces)
KV 30 C	3	50	100
KV 40 C	4	50	100
KV 50 C	5	50	100
KV 50/6 C	5	50	100
KV 60 C	6	50	100
KV 70 C	7	50	100
KV 71 C	7	50	100
KV 81 C	8	50	100

Packaging:

pre-assembled, in a cardboard box