









## Ficha técnica

### Rueda BH-PPI 2-2462

Codigo				Tipo cojinete Eje					
2-2462	100	80	22	—	70x55	54x38	6	132	90



#### Características

Fabricada con chapa de acero hasta 2 m/m de espesor.  
Soporte con doble rodamiento a bolas.  
Acabado cincado brillante.  
Fabricadas según normas europeas EN 12528/12530.

#### Datos técnicos

**Diámetro:** 100 mm  
**Carga:** 80 kg  
**Tipo de cojinete:** Cojinete Liso  
**Ancho de Banda de rodadura:** 22 mm  
**Medidas de placa superior:** 70x55 mm  
**Distancia entre agujeros:** 54x38 mm  
**Diámetro agujero sujeción platina:** 6 mm  
**Altura total:** 132 mm  
**Radio de giro:** 90 mm

#### Archivos CAD

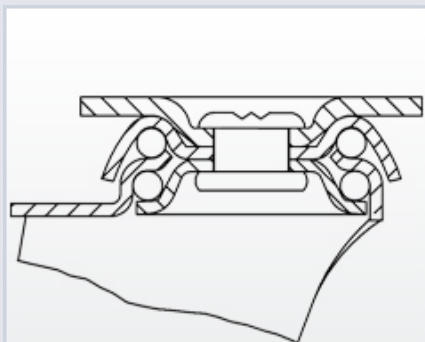

#### Rueda

**PPI (Poliuretano)**  
Núcleo de poliamix y banda de poliuretano( 95° shore A)  
**Rango de temperatura:** -25° ÷ +80°

#### Productos relacionados

