



Part no.: 50109719
IS 230MM/2NO-15N-S12
Inductive switch



Figure can vary

Contents

- Technical data
- Dimensioned drawings
- Electrical connection
- Diagrams
- Operation and display
- Part number code
- Notes
- Accessories

Technical data

| Basic data | |
|----------------------------------|---------------|
| Series | 230 |
| Typ. operating range limit S_n | 15 mm |
| Operating range S_a | 0 ... 12.1 mm |

| Electrical data | |
|------------------------|---|
| Protective circuit | Inductive protection Polarity reversal protection Short circuit protected |

| Performance data | |
|--|---|
| Supply voltage U_B | 10 ... 30 V , DC |
| Residual ripple | 0 ... 20 % , From U_B |
| Open-circuit current | 0 ... 10 mA |
| Temperature drift, max. (in % of S_r) | 10 % , Over the entire operating temperature range |
| Repeatability, max. (in % of S_r) | 5 % , For $U_B = 20 \dots 30$ V DC, ambient temperature $T_a = 23 \text{ °C} \pm 5 \text{ °C}$ |
| Switching hysteresis | 20 % |

| Outputs | |
|-------------------------------------|------------|
| Number of digital switching outputs | 1 Piece(s) |

| Switching outputs | |
|--------------------------|------------|
| Voltage type | DC |
| Switching current, max. | 200 mA |
| Residual current, max. | 0.1 mA |
| Voltage drop | ≤ 2 V |

| Switching output 1 | |
|---------------------------|--------------------|
| Switching element | Transistor , NPN |
| Switching principle | NO (normally open) |

| Timing | |
|---------------------|--------|
| Switching frequency | 700 Hz |
| Readiness delay | 60 ms |

| Connection | |
|-----------------------|------------|
| Number of connections | 1 Piece(s) |

| Connection 1 | |
|---------------------|------------------------------|
| Type of connection | Connector |
| Function | Signal OUT Voltage supply |
| Thread size | M12 |
| Type | Male |
| Material | Metal |
| No. of pins | 4 -pin |
| Encoding | A-coded |

| Mechanical data | |
|--------------------------------|-----------------|
| Design | Cylindrical |
| Thread size | M30 x 1.5 mm |
| Dimension (\varnothing x L) | 30 mm x 63.5 mm |
| Type of installation | Non-embedded |

Part no.: 50109719 – IS 230MM/2NO-15N-S12 – Inductive switch

| | |
|--------------------------|---------------------------------|
| Housing material | Metal , Nickel-plated brass |
| Sensing face material | Plastic , Polybutylene (PBT) |
| Net weight | 130 g |
| Housing color | Red, RAL 3000 Silver |
| Type of fastening | Mounting thread |
| Standard measuring plate | 45 x 45 mm ² , Fe360 |

Operation and display

| | |
|-----------------|------------|
| Type of display | LED |
| Number of LEDs | 1 Piece(s) |

Environmental data

| | |
|--------------------------------|---------------|
| Ambient temperature, operation | -25 ... 70 °C |
| Ambient temperature, storage | -25 ... 70 °C |

Certifications

| | |
|--|---|
| Degree of protection | IP 67 |
| Protection class | II |
| Certifications | c UL US |
| Test procedure for EMC in accordance with standard | IEC 61000-4-2 IEC 61000-4-3 IEC 61000-4-4 |
| Standards applied | IEC 60947-5-2 |

Correction factors

| | |
|-----------------|------|
| Aluminum | 0.5 |
| Stainless steel | 0.85 |
| Copper | 0.4 |
| Brass | 0.5 |
| Fe360 steel | 1 |

Classification

| | |
|-----------------------|----------|
| Customs tariff number | 85365019 |
| eCl@ss 8.0 | 27270101 |
| eCl@ss 9.0 | 27270101 |
| ETIM 5.0 | EC002714 |
| ETIM 6.0 | EC002714 |

Dimensioned drawings

All dimensions in millimeters

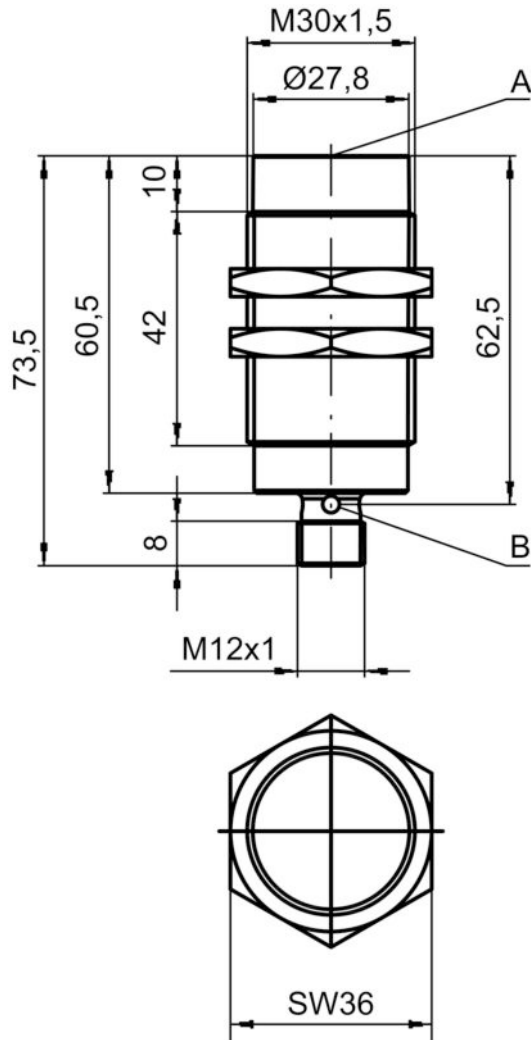

A Active surface
B Yellow LED

Electrical connection

| Connection 1 | |
|--------------------|------------------------------|
| Type of connection | Connector |
| Function | Signal OUT Voltage supply |
| Thread size | M12 |
| Type | Male |
| Material | Metal |
| No. of pins | 4 -pin |
| Encoding | A-coded |

| Pin | Pin assignment |
|-----|----------------|
| 1 | V+ |
| 2 | n.c. |
| 3 | GND |
| 4 | OUT 1 |

Diagrams

Non-embedded installation

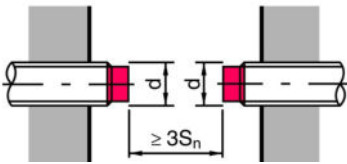
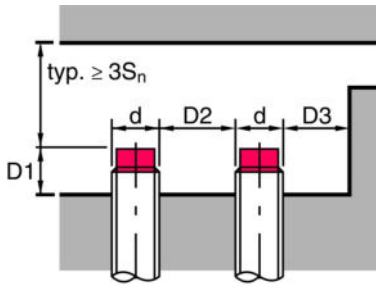

| | |
|------------|----|
| S_n [mm] | 15 |
| D1 [mm] | 13 |
| D2 [mm] | 45 |
| D3 [mm] | 15 |

Types with $S_n = 15.0$ mm

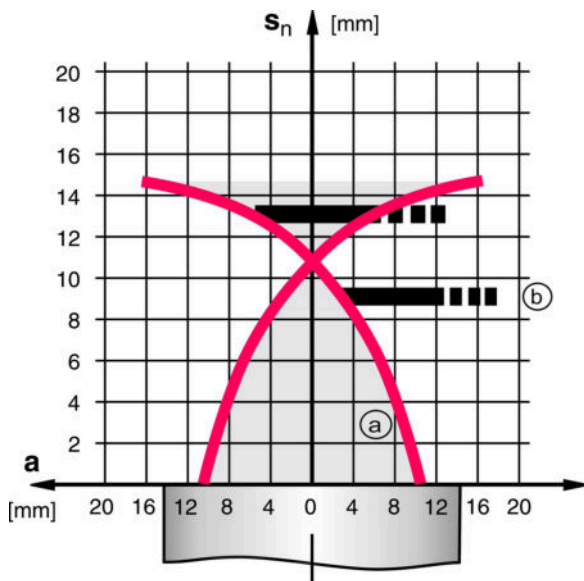

- ON (a)
- — — — (b)

- a Inductive switch
- b Standard measuring plate

Operation and display

LEDs

| LED | Display | Meaning |
|-----|--------------------------|----------------------------------|
| 1 | Yellow, continuous light | Switching output/switching state |

Part number code

Part designation: ISX YYY ZZ/AAA.BB-CCC-DDD-DDD

| | |
|-----|---|
| ISX | Operating principle / construction: IS: inductive switch, standard design ISS: inductive switch, short construction |
| YYY | Series: 203: series with Ø 3 mm 204: series with Ø 4 mm 205: series with M5 x 0.5 external thread 206: series with Ø 6.5 mm 208: series with M8 x 1 external thread 212: series with M12 x 1 external thread 218: series with M18 x 1 external thread 230: series with M30 x 1.5 external thread 240: series in cubic design 244: series in cubic design 255: series with 5 x 5 mm ² cross section 288: series with 8 x 8 mm ² cross section |
| ZZ | Housing / thread: MM: metal housing (active surface: plastic) / metric thread FM: full-metal housing (active surface: stainless steel AISI 316L) / metric thread MP: metal housing (active surface: plastic) / smooth (without thread) |
| AAA | Output current / supply: 4NO: PNP transistor, NO contact 4NC: PNP transistor, NC contact 2NO: NPN transistor, NO contact 2NC: NPN transistor, NC contact 1NO: relay, NO contact / AC/DC 1NC: relay, NC contact / AC/DC 44: 2 PNP transistor switching outputs, antivalent (NO + NC) 22: 2 NPN transistor switching outputs, antivalent (NO + NC) |
| BB | Special equipment: n/a: no special equipment 5F: food version 5: housing material V2A (1.4305, AISI 303) |
| CCC | Measurement range / type of installation: 1E0: typ. range limit 1.0 mm / embedded installation 1E5: typ. range limit 1.5 mm / embedded installation 2E0: typ. range limit 2.0 mm / embedded installation 3E0: typ. range limit 3.0 mm / embedded installation 4E0: typ. range limit 4.0 mm / embedded installation 5E0: typ. range limit 5.0 mm / embedded installation 6E0: typ. range limit 6.0 mm / embedded installation 8E0: typ. range limit 8.0 mm / embedded installation 10E: typ. range limit 10.0 mm / embedded installation 12E: typ. range limit 12.0 mm / embedded installation 15E: typ. range limit 15.0 mm / embedded installation 20E: typ. range limit 20.0 mm / embedded installation 22E: typ. range limit 22.0 mm / embedded installation 2N5: typ. range limit 2.5 mm / non-embedded installation 4N0: typ. range limit 4.0 mm / non-embedded installation 8N0: typ. range limit 8.0 mm / non-embedded installation 10N: typ. range limit 10.0 mm / non-embedded installation 12N: typ. range limit 12.0 mm / non-embedded installation 14N: typ. range limit 14.0 mm / non-embedded installation 15N: typ. range limit 15.0 mm / non-embedded installation 20N: typ. range limit 20.0 mm / non-embedded installation 22N: typ. range limit 22.0 mm / non-embedded installation 25N: typ. range limit 25.0 mm / non-embedded installation 40N: typ. range limit 40.0 mm / non-embedded installation |
| DDD | Electrical connection: n/a: cable, standard length 2000 mm S12: M12 connector, 4-pin, axial 200-S12: cable, length 200 mm with M12 connector, 4-pin, axial 200-S8.3: cable, length 200 mm with M8 connector, 3-pin, axial S8.3: M8 connector, 3-pin, axial 005-S8.3: cable, length 500 mm with M8 connector, 3-pin, axial 050: cable, standard length 5000 mm, 3-wire |

Note

A list with all available device types can be found on the Leuze electronic website at www.leuze.com.

Notes

Observe intended use!



- This product is not a safety sensor and is not intended as personnel protection.
- The product may only be put into operation by competent persons.
- Only use the product in accordance with its intended use.

For UL applications:

- For UL applications, use is only permitted in Class 2 circuits in accordance with the NEC (National Electric Code).



Accessories

Connection technology - Connection cables

| | Part no. | Designation | Article | Description |
|---|----------|--------------------|------------------|--|
|  | 50130654 | KD U-M12-4A-P1-020 | Connection cable | Connection 1: Connector, M12, Axial, Female, A-coded, 4 -pin Connection 2: Open end Shielded: No Cable length: 2,000 mm Sheathing material: PUR |
|  | 50130657 | KD U-M12-4A-P1-050 | Connection cable | Connection 1: Connector, M12, Axial, Female, A-coded, 4 -pin Connection 2: Open end Shielded: No Cable length: 5,000 mm Sheathing material: PUR |
|  | 50130648 | KD U-M12-4A-V1-020 | Connection cable | Connection 1: Connector, M12, Axial, Female, A-coded, 4 -pin Connection 2: Open end Shielded: No Cable length: 2,000 mm Sheathing material: PVC |
|  | 50130688 | KD U-M12-4W-V1-020 | Connection cable | Connection 1: Connector, M12, Angled, Female, A-coded, 4 -pin Connection 2: Open end Shielded: No Cable length: 2,000 mm Sheathing material: PVC |

Part no.: 50109719 – IS 230MM/2NO-15N-S12 – Inductive switch

Mounting technology - Other

| | Part no. | Designation | Article | Description |
|---|----------|-------------|---------|---|
|  | 50132730 | AC D30M-CS | Clamp | Contains: 2x M36 mounting nut Diameter, inner: 30 mm Design of mounting device: Mounting clamp Fastening, at system: Screw type, Through-hole mounting Mounting bracket, at device: insertable, Clampable with limit stop Type of mounting device: Clampable, With limit stop Material: Metal |
|  | 50111503 | MC 030K | Clamp | Diameter, inner: 30 mm Design of mounting device: Mounting clamp Fastening, at system: Through-hole mounting Mounting bracket, at device: Clampable Type of mounting device: Rigid Material: Plastic |

Note

A list with all available accessories can be found on the Leuze electronic website in the Download tab of the article detailed page.