

**Actuator/Sensor cable, PUR**  
**Connection cable**  
**WSC4T-5/TXO**

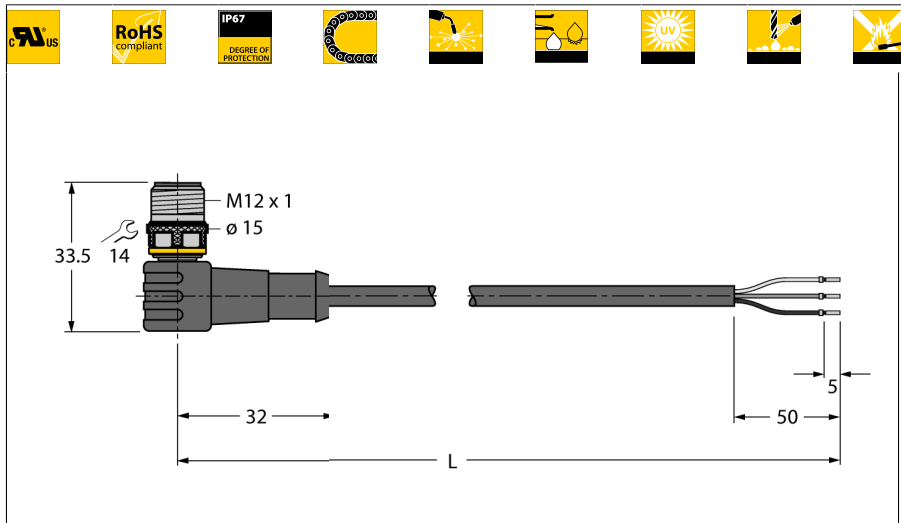

- Male M12, angled, 3-pin
- Sheath material: PUR
- Sheath color: orange
- Qualified for drag chain use
- Resistant to weld splatter
- Resistant to chemicals, UV radiation and oils
- Flame retardant
- Free from halogen, silicone, PVC and LABS
- Particularly resistant to abrasion
- Approval: cULus
- RoHS conform
- Protection class IP67
- Cable length: 5.0 m

<b>Type designation</b>	WSC4T-5/TXO
Ident no.	6629633

<b>Connector A side</b>	Connector, M12 ⚡ 1, Angled
Number of pins	3
Contacts	Brass, CuZn, Gold-plated
Contact carriers	Plastic, TPU, Black
Grip	Plastic, TPU, Black
Coupling nut/screw	Brass, CuZn, Nickel-plated
Protection class	IP67, A + B side screwed together
Mechanical lifespan	> 100 Mating cycles
Pollution degree	3
Tightening torque	0.8 ... 1 Nm (observe max. torque of counter piece!)

<b>General data</b>	
Cable diameter	4.3 ± 0.20mm
Cable length	5 m
Cable quality	PUR
Cable color	Orange
Core insulation	PP
Core colors	BN, BU, BK
Core cross-section	3x0.34mm <sup>2</sup>
Arrangement of strands	42x0.1 mm

<b>Electrical features at +20 °C</b>	
Current	4 A
Rated voltage	250 V
Insulation resistance	> 30.5 MΩ/km
Test voltage	2000 V
Forward resistance	max. 57 Ω/km

<b>Mechanical and chemical properties</b>	
Max. tensile strength (static)	≤ 50 N/mm <sup>2</sup>
Max. tensile strength (dynamic)	≤ 20 N/mm <sup>2</sup>
Bending cycles	> 5 mil.
Bending radius (stationary laying)	> 5 x Ø
Bending radius (flexible use)	> 10 x Ø
Admissible acceleration	max. 5 m/s <sup>2</sup>
Admissible travel path, horizontal	5 m (at 5 m/s <sup>2</sup> )
Admissible travel path, vertical	2 m (at 5 m/s <sup>2</sup> )
Admissible traversing speed	3.3 m/s
Torsional stress	± 180 °/m
Ambient temperature	
Stationary	-50...+80°C
In motion	-25...+80°C
Drag chain operation	-25...+60°C

**Cable Cross-section**

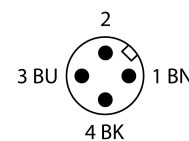
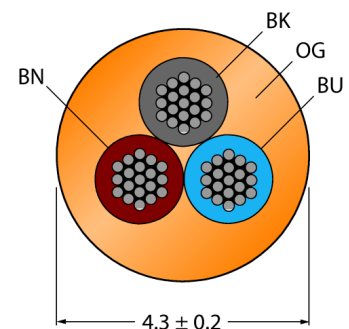

**General information**

Drawing depicts design version including hexagon coupling nut (Production date after CW11/2016).

**Circuit Diagram**

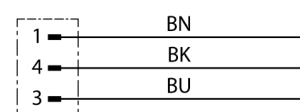



**Actuator/Sensor cable, PUR**  
**Connection cable**  
**WSC4T-5/TXO**

**TURCK**

Industrial  
Automation

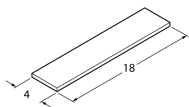
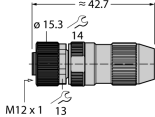
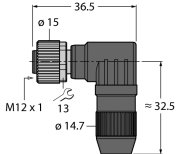
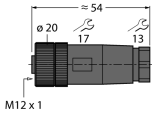
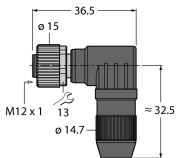
**Accessories**

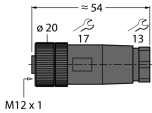
Type code	Ident no.	Description	
Torque-Wrench-Set-AS	6936170	Torque wrench set; handles with adjustable torque 0.4-1.0 Nm, torque wrench for M8 (SW9), fork wrench for M12 (SW 14)	
BLANK-LABEL-FOR-CORDSETS-TEL-TXL	6936206	Label for TEL and TXL cables, length: 18 mm, height: 4 mm, material: polycarbonate (PC), color: white, halogen-free and flame-retardant	
HA8141-0	6905407	Field-wireable female connector, M12  1, straight, 4-pin, insulation piercing connection, cable feedthrough 4.0 to 5.1 mm, core cross-section/terminal capacity 0.14 to 0.34 mm <sup>2</sup> , plastic housing, metal nut	
HA8241-0	6905401	Field-wireable female connector, M12  1, angled, 4-pin, insulation piercing connection, cable feedthrough 4.0 to 5.1 mm, core cross-section/terminal capacity 0.14 to 0.34 mm <sup>2</sup> , plastic housing, metal nut	
B8141-0	69049	Field-wireable female connector, M12  1, straight, 4-pin, screw terminal connection, cable feedthrough 4.0 to 6.0 mm, core cross-section/terminal capacity 0.14 to 0.75 mm <sup>2</sup> , plastic housing, plastic nut	

**Actuator/Sensor cable, PUR**  
**Connection cable**  
**WSC4T-5/TXO**

**Accessories**

Type code	Ident no.	Description	
B8241-0	69048	Field-wireable female connector, M12 4-pin, angled, 4-pin, screw terminal connection, cable feedthrough 4.0 to 6.0 mm, core cross-section/terminal capacity 0.14 to 0.75 mm <sup>2</sup> , plastic housing, plastic nut	
BM8141-0	6935145	Field-wireable female connector, M12 4-pin, straight, 4-pin, screw terminal connection, cable feedthrough 4.0 to 6.0 mm, core cross-section/terminal capacity 0.25 to 0.75 mm <sup>2</sup> , plastic housing, metal nut	
BM8241-0	6935889	Field-wireable female connector, M12 4-pin, angled, 4-pin, screw terminal connection, cable feedthrough 4.0 to 6.0 mm, core cross-section/terminal capacity 0.25 to 0.75 mm <sup>2</sup> , plastic housing, metal nut	