

**Food & Beverage Hygienic, TPE
Connection Cable
WKH4-2/TFG**

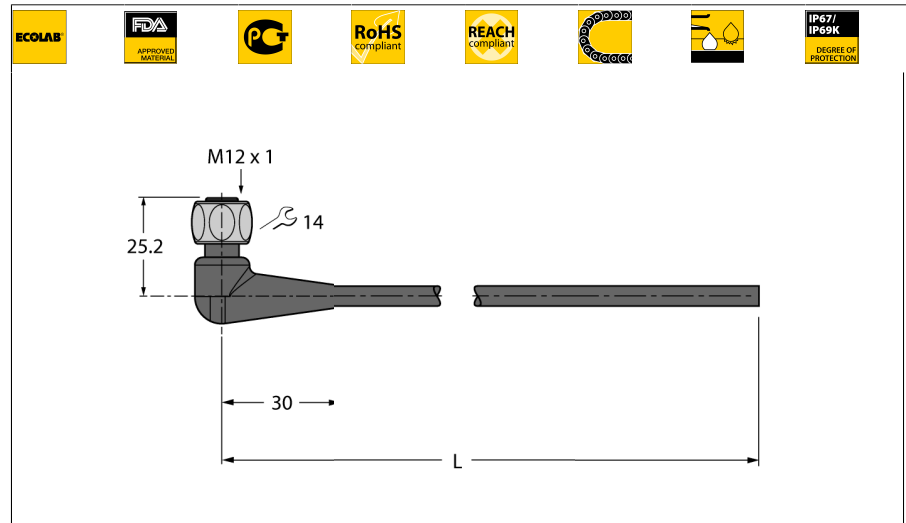

- M12 female connector, angled, 3-pin
- Stainless steel coupling nut/screw
- Sheath material: TPE-O
- Sheath color: light gray RAL 7035
- Qualified for drag chain use
- Resistant to chemicals and microbes
- Weatherproof
- Resistant to hydrolysis acc. to DIN EN 60068-2-78
- Flexible at low temperatures
- Free from silicone and PVC
- Halogen-free acc. to DIN EN 50267-2-1, IEC 60754-1, VDE 0482-267-2-1
- Approvals: Gost, Ecolab, FDA
- RoHS and REACH compliant
- Protection classes IP67, IP69K
- Cable length: 2.0 m

Type designation	WKH4-2/TFG
Ident no.	6934389

Connector A side	Female connector, M12 - 1, Angled
Number of pins	3
Contacts	Brass, CuZn, Gold-plated
Contact carriers	Plastic, PP, Gray
Grip	Plastic, PP, Gray
Coupling nut/screw	Stainless steel, V4A
Seal	Plastic, FPM/FKM
Protection class	IP67, IP69K, A + B side screwed together
Mechanical lifespan	> 100 Mating cycles
Pollution degree	3
Tightening torque	0.8 ... 1 Nm (observe max. torque of counter piece!)

General data	
Cable diameter	4.6 ± 0.15mm
Cable length	2 m
Cable quality	TPE-O
Cable color	Gray
Core insulation	TPE-E
Core colors	BN, BU, BK
Core cross-section	4x0.34mm ²
Arrangement of strands	42x0.1 mm

Electrical features at +20 °C	
Current	4 A
Rated voltage	250 V
Nom. Inductance	0.73 mH/km
Nom. capacitance	82 pF/m
Test voltage	2000 V

Cable Cross-section

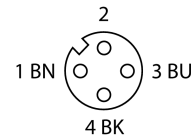
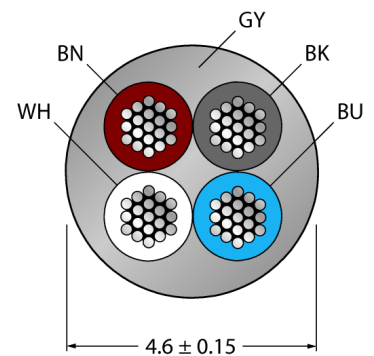

Circuit Diagram

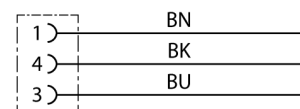

Food & Beverage Hygienic, TPE Connection Cable WKH4-2/TFG

TURCK

Industrial
Automation

Mechanical and chemical properties

Max. tensile strength (static)	≤ 50 N/mm ²
Max. tensile strength (dynamic)	≤ 20 N/mm ²
Bending cycles	> 4 mil.
Bending radius (stationary laying)	> 5 x Ø
Bending radius (flexible use)	> 10 x Ø
Admissible acceleration	max. 5 m/s ²
Admissible travel path, horizontal	5 m (at 5 m/s ²)
Admissible travel path, vertical	2 m (at 5 m/s ²)
Admissible traversing speed	3 m/s
Torsional stress	± 180 °/m
Ambient temperature	
Stationary	-40...+105°C
In motion	-25...+105°C
Drag chain operation	-25...+60°C