



### Main

Range of product	OsiSense XC
Series name	Standard format
Product or component type	Limit switch
Device short name	XCMD
Sensor design	Miniature
Body type	Plug-in body
Head type	M12 plunger head
Material	Metal
Body material	Zamak
Head material	Zamak
Fixing mode	By the head
Movement of operating head	Linear
Type of operator	Spring return roller plunger metal
Type of approach	Lateral approach, 2 directions
Number of poles	1
Contacts type and composition	1 C/O
Contact operation	Snap action

### Complementary

Switch actuation	By 30° cam
Electrical connection	Male connector M12, 4 pins
Contacts insulation form	Za
Positive opening	Without
Minimum force for tripping	7 N
Maximum actuation speed	10 cm/s
[Ie] rated operational current	1.5 A 240 V, AC-15 EN/IEC 60947-5-1 appendix A 0.1 A 250 V, DC-13 EN/IEC 60947-5-1 appendix A
[Ithe] conventional enclosed thermal current	3 A
[Ui] rated insulation voltage	250 V 3)IEC 60947-5-1
Maximum resistance across terminals	25 mOhm conforming to IEC 60255-7 category 3
[Uimp] rated impulse withstand voltage	2.5 KV IEC 60664 2.5 kV IEC 60947-1
Short-circuit protection	4 A cartridge fuse gG
Electrical durability	5000000 Cycles, DC-13, 24 V, 3 W, operating rate <60 cyc/mn, load factor: 0.5 conforming to IEC 60947-5-1 appendix C 5000000 Cycles, DC-13, 48 V, 2 W, operating rate <60 cyc/mn, load factor: 0.5 conforming to IEC 60947-5-1 appendix C 5000000 cycles, DC-13, 120 V, 1 W, operating rate <60 cyc/mn, load factor: 0.5 conforming to IEC 60947-5-1 appendix C
Mechanical durability	10000000 cycles
Maximum Width	1.18 in (30 mm)
Height	1.97 in (50 mm)
Depth	0.63 in (16 mm)
Net Weight	0.24 lb(US) (0.11 kg)

The information provided in this documentation contains general descriptions and/or technical characteristics of the performance of the products contained herein. This documentation is not intended as a substitute for and is not to be used for determining suitability or reliability of these products for specific user applications. It is the duty of any such user or integrator to perform the appropriate and complete risk analysis, evaluation and testing of the products with respect to the relevant specific application or use thereof. Neither Schneider Electric Industries SAS nor any of its affiliates or subsidiaries shall be responsible or liable for misuse of the information contained herein.

## Environment

Shock resistance	25 gn for 18 ms conforming to IEC 60068-2-27
Vibration resistance	5 gn 10...500 Hz)IEC 60068-2-6
IP degree of protection	IP66 conforming to IEC 60529 IP67 IEC 60529 IP68 IEC 60529
IK degree of protection	IK06 conforming to EN 62262
Electrical shock protection class	Class I IEC 61140 Class I NF C 20-030
Ambient air temperature for operation	-13...158 °F (-25...70 °C)
Ambient air temperature for storage	-40...158 °F (-40...70 °C)
Protective treatment	TC
Product certifications	CSA UL CCC
Standards	CSA C22.2 No 14 UL 508 EN/IEC 60947-5-1 EN/IEC 60204-1

## Ordering and shipping details

Category	22413 - LIMIT SWITCH, IEC, MINIATURE
Discount Schedule	T
GTIN	00785901913139
Nbr. of units in pkg.	1
Package weight(Lbs)	0.7 lb(US) (0.32 kg)
Returnability	No
Country of origin	ID

## Packing Units

Unit Type of Package 1	PCE
Package 1 Height	0.71 in (1.8 cm)
Package 1 width	2.09 in (5.3 cm)
Package 1 Length	3.46 in (8.8 cm)
Unit Type of Package 2	S01
Number of Units in Package 2	40
Package 2 Weight	10.55 lb(US) (4.785 kg)
Package 2 Height	5.91 in (15 cm)
Package 2 width	5.91 in (15 cm)
Package 2 Length	15.75 in (40 cm)

## Offer Sustainability

Sustainable offer status	Green Premium product
California proposition 65	WARNING: This product can expose you to chemicals including: Diisononyl phthalate (DINP), which is known to the State of California to cause cancer, and Di-isodecyl phthalate (DIDP), which is known to the State of California to cause birth defects or other reproductive harm. For more information go to <a href="http://www.P65Warnings.ca.gov">www.P65Warnings.ca.gov</a>
REACH Regulation	<a href="#">REACH Declaration</a>
EU RoHS Directive	Pro-active compliance (Product out of EU RoHS legal scope) <a href="#">EU RoHS Declaration</a>
Mercury free	Yes
RoHS exemption information	<a href="#">Yes</a>
Environmental Disclosure	<a href="#">Product Environmental Profile</a>
Circularity Profile	<a href="#">End Of Life Information</a>

## Contractual warranty

---

Warranty	18 months
----------	-----------

---

Dimensions

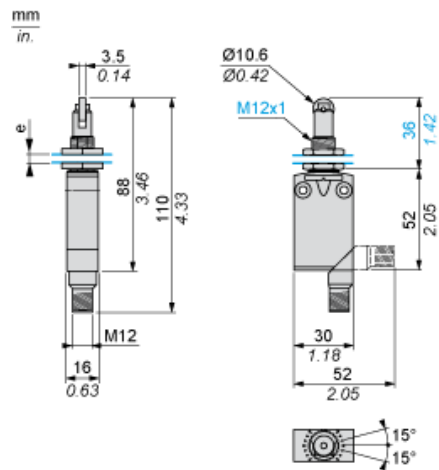

e : 8 mm max, panel cut-out Ø 12.5 mm, fixing nut thickness 3.5 mm.

---

Panel Mounting

---

Mounting and Fixing Limit Switches by the Head

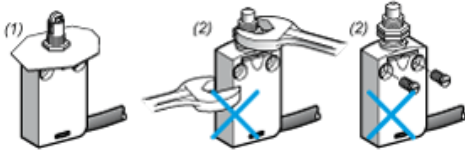

- (1) Recommended
- (2) Forbidden

---

Setting-up

---

Plunger or Multi-directional Heads

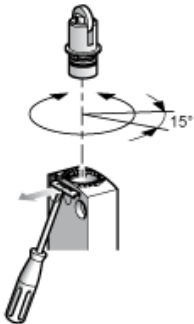

---

## Wiring Diagram

---

Single-pole CO Snap Action + Integral M12 4-pin Connector

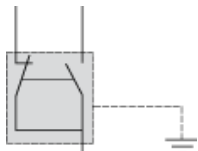

---

## Wiring Diagram

---

4-pin, M12, 3A-250V

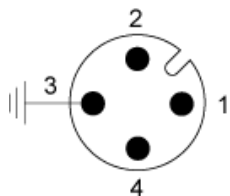

- 1: Common
- 2: NC
- 3: Grounding
- 4: NO

Characteristics of Actuation

Switch Actuation by 30° Cam

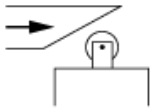

Functionnal Diagram

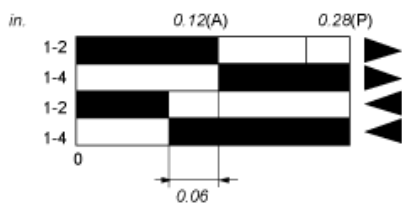
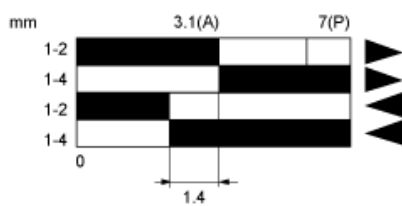

- (1)
- (2)
- ▶ (3)
- ◀ (4)

- (P) Positive opening point
- (A) Cam displacement
- (1) Closed
- (2) Open
- (3) Tripping
- (4) Resetting