

System Board 6261

MAXREFDES112#: ISOLATED 24V TO 12V 10W FLYBACK POWER SUPPLY

Maxim's power supply experts have designed and built a series of isolated, industrial power-supply reference designs. Each of these power supplies efficiently converts 24V into useful voltage rails at a variety of power levels. Every power rail is isolated with a readily available transformer from multiple, global vendors, providing for quick, convenient transformer selection. Each design has been tested for load and line regulation, as well as efficiency and transient performance. As with all Maxim reference designs, the BOM, schematics, layout files, and Gerber files are all available. In addition, boards are available for purchase; most boards feature through-hole pins for immediate board placement and accelerated prototyping.

MAXREFDES112# is an efficient flyback topology with 24V input, and a 12V output at 10W of power (0.8A). The design features the MAX17596, a peak-current-mode converter with flexible switching frequency. This entire circuit fits on a 20.3mm (0.8in) x 59.7mm (2.35in) board.

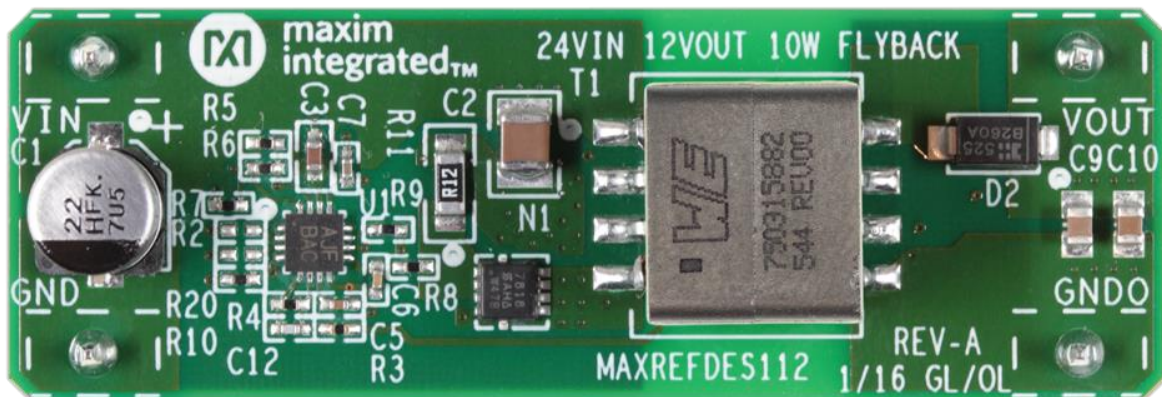

Features

- Functional insulation
- Compact and flexible
- Minimal external components
- Robust operation in adverse industrial environments
- 12V 800mA with 20% over range current
- $\pm 5\%$ output accuracy

Applications

- Industrial control and automation
- Process control
- PLC
- Telecom and Datacom power supplies

Introduction

Isolated power supplies provide reliable power regulation for a variety of applications. Transformer selection is often the most difficult step in isolated power design. The MAXREFDES112# is a compact 24V input flyback converter module that features 12V at 800mA output. Multiple transformers (Halo Electronics TGSP-P145EP10LF, Würth Electronics 750315882, HanRun HR051075, and Sumida 12387T070) have been qualified for this design, simplifying the process of transformer selection. In addition, through-hole pins on the bottom side of the module allows quick and easy integration of this power converter into the main system. Pins are 0.6in from power to ground, and 2in from the input side to the output side.

The MAX17596 is a peak-current-mode controller for design of wide input-voltage flyback and boost regulators. The reference design operates over a 17V to 36V input voltage range, and provides up to 800mA (plus 20% overhead) at 12V output. The MAX17596 has an internal amplifier with 1% accurate reference, eliminating the need for an external reference. The switching frequency is programmable from 100kHz to 1MHz with an accuracy of 8%, allowing optimization of magnetic and filter components, resulting in compact and cost-effective power conversion. This design is set to switch at 500kHz. For EMI-sensitive applications, the MAX17596 incorporates a programmable frequency dithering scheme, enabling low-EMI spread-spectrum operation.

The input undervoltage lockout (EN/UVLO) is provided for programming the input-supply start voltage (set to 17V in the design), and to ensure proper operation during brownout conditions. The EN/UVLO input is also used to turn on/off the IC. The overvoltage input (OVI) protection scheme is provided to make sure that the controller shuts down when the input supply exceeds its maximum allowed value (set to 36V in the design).

A capacitor is connected to the SS pin to program the soft-start period hence reduces the input inrush current during startup. Hiccup-mode overcurrent protection and thermal shutdown are provided to minimize dissipation in overcurrent and overtemperature fault conditions.

The reference design delivers a peak efficiency of 88% with the supplied components when the input is 24V. This general-purpose power solution can be used in many different types of power applications, such as programmable logic controllers (PLC), industrial process control, industrial sensors, telecom power supplies, isolated battery chargers, servers, and embedded computing.

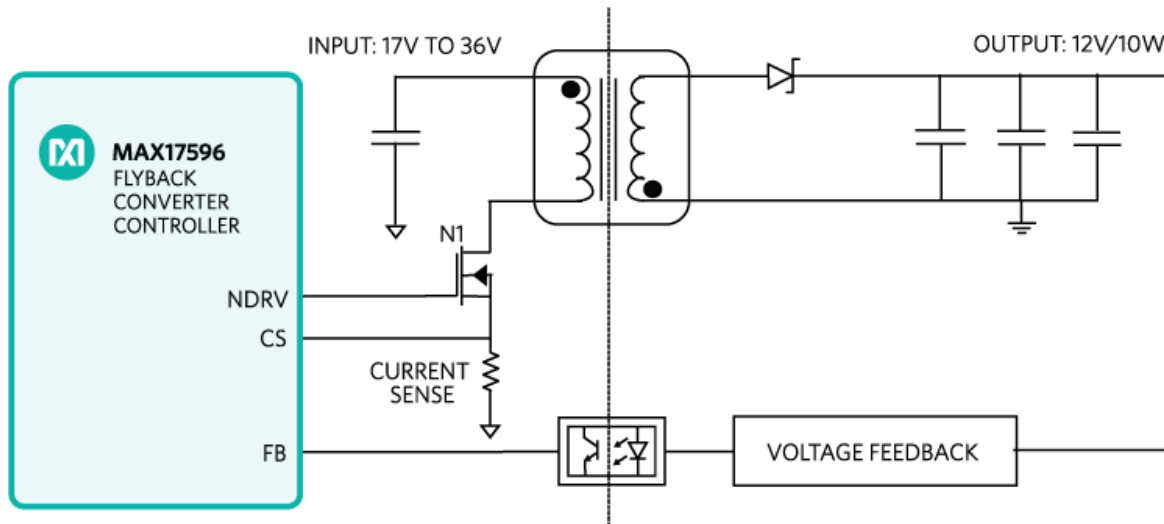

Detailed Circuit Description

The MAXREFDES112# reference design contains all the control circuitry and electric components required for designing a 17V to 36V wide-input, 12V 10W output isolated flyback converter power supply.

When the MOSFET is turned on, the current flows through the primary winding of the transformer and stores the energy. The CS-pin input and the current sense resistor set the peak current limit and provide overcurrent protection. When the MOSFET is turned off, the energy stored in the primary side is transferred to the secondary side.

The secondary side of the circuit consists of a diode, and a few output capacitors. When the MOSFET on the primary side is off, the transformer pushes the current to the load at the output and the remaining energy is stored in the output capacitors. When the MOSFET is on, the diode prevents the current flow back into the transformer and discharges the output capacitors.

The feedback network is typical of most isolated flyback converters. It is constructed using a TL431 programmable shunt regulator, a 3000V isolation opto-coupler, and other RC components.

Startup Voltage and Input Overvoltage Protection Setting (EN/UVLO, OVI)

The EN/UVLO pin in the MAX17596 serves as an enable/disable input, as well as an accurate programmable undervoltage lockout (UVLO) pin. The MAX17596 does not begin startup operations unless the EN/UVLO pin voltage exceeds 1.21V (typ). The MAX17596 turns off if the EN/UVLO pin voltage falls below 1.15V (typ). A resistor divider from the input DC bus to ground can be used to divide down and apply a fraction of the input DC voltage to the EN/UVLO pin. The values of the resistor divider can be selected so that the EN/UVLO-pin voltage exceeds the 1.21V (typ) turn-on threshold at the desired input DC bus voltage. The same resistor divider can be modified with an additional resistor, R_{OVI} , to implement overvoltage input protection in addition to the EN/UVLO functionality. When the voltage at the OVI pin exceeds 1.21V (typ), the MAX17596 stops switching. Switching resumes with soft-start operation, only if the voltage at the OVI pin falls below 1.15V (typ). For the expected values of the startup DC input voltage (V_{START}) and overvoltage-input protection voltage (V_{OVI}), the resistor values for the divider can be calculated as follows:

$$V_{START} = (R65 + R6 + R7)/(R6 + R7) \times 1.21 \text{ (V)}$$

$$V_{OVI} = (R5 + R6 + R7)/R7 \times 1.21 \text{ (V)}$$

If $R5 = 274\text{k}\Omega$, $R6 = 11.3\text{k}\Omega$, and $R7 = 9.76\text{k}\Omega$, then:

$$V_{START} = 16.95\text{V}, V_{OVI} = 36.6\text{V}.$$

Quick Start

Required equipment:

- MAXREFDES112# board
- One 24V DC power supply
- One electronic load
- 1 voltmeters
- 1 ammeters

Procedure

The MAXREFDES112# board is fully assembled and tested. Use the following steps to verify board operation.

1. Turn off the power supply.
2. Connect the positive terminal of the power supply to the VIN pin of the MAXREFDES112# board.

3. Connect the negative terminal of the power supply to the GND pin of the MAXREFDES112# board.
4. Connect the VOUT connector of the MAXREFDES112# board to the positive terminal of the electronic load.
5. Connect the negative terminal of the electronic load to the positive terminal of the ammeter.
6. Connect the negative terminal of the ammeter to the GNDO connector of the MAXREFDES112# board.
7. Connect the voltmeter across the VOUT and the GNDO connectors of the MAXREFDES112# board.
8. Turn on the power supply.
9. Set the electronic load to a constant current between 0mA to 800mA.
10. Verify the second voltmeter reading is $12V \pm 0.6V$.

Lab Measurements

The MAXREFDES112# design was verified and tested under full input range and different output load conditions.

The power efficiency vs. load current is illustrated in **Figure 2**.

Data were gathered from MAXREFDES112D#. All versions perform similarly.

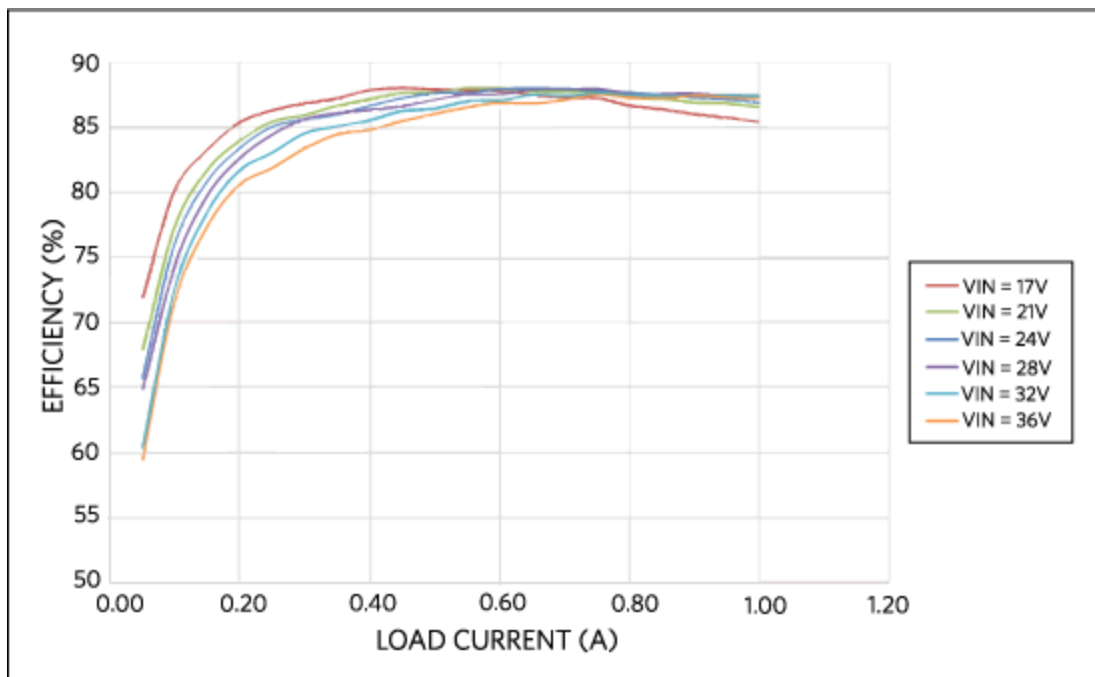

Figure 2.

Power efficiency vs. load current.

Figure 3 display the output ripple at full load (ripple + spike is $110\text{mV}_{\text{P-P}}$) when the input is 24V .

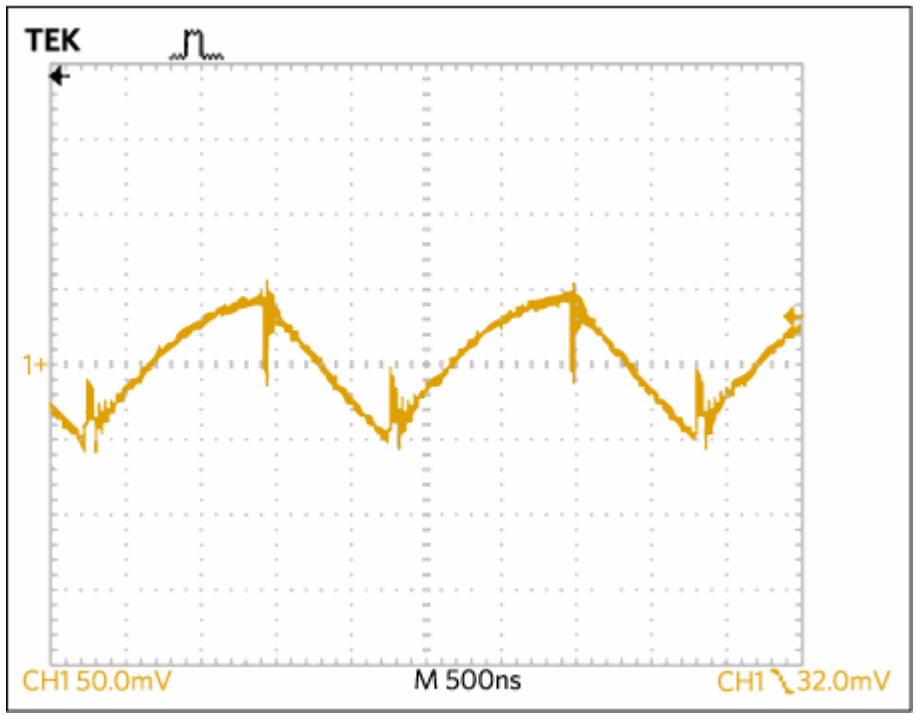

Figure 3. Output ripple

at 800mA load, 12V_{out} .

Figure 4 displays the load transient response when the load is stepped from 5mA to 320mA , and then dropped back to 5mA again. The output transient spike is about 240mV . The input is 24V and output is 12V .

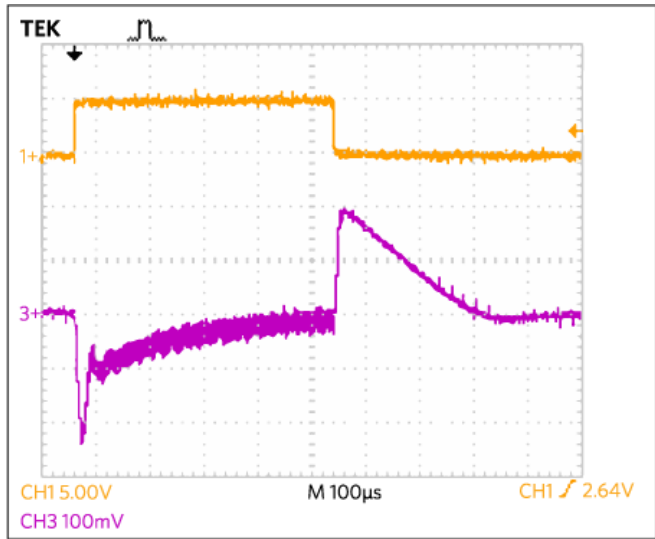

Figure 4. Transient response when load

steps from 5mA to 320mA .

Figure 5 shows the load transient response when the load is stepped from 480mA to 800mA, and then dropped back to 480mA again. The transient voltage is about 200mV. The input is 24V, and the output is 12V.

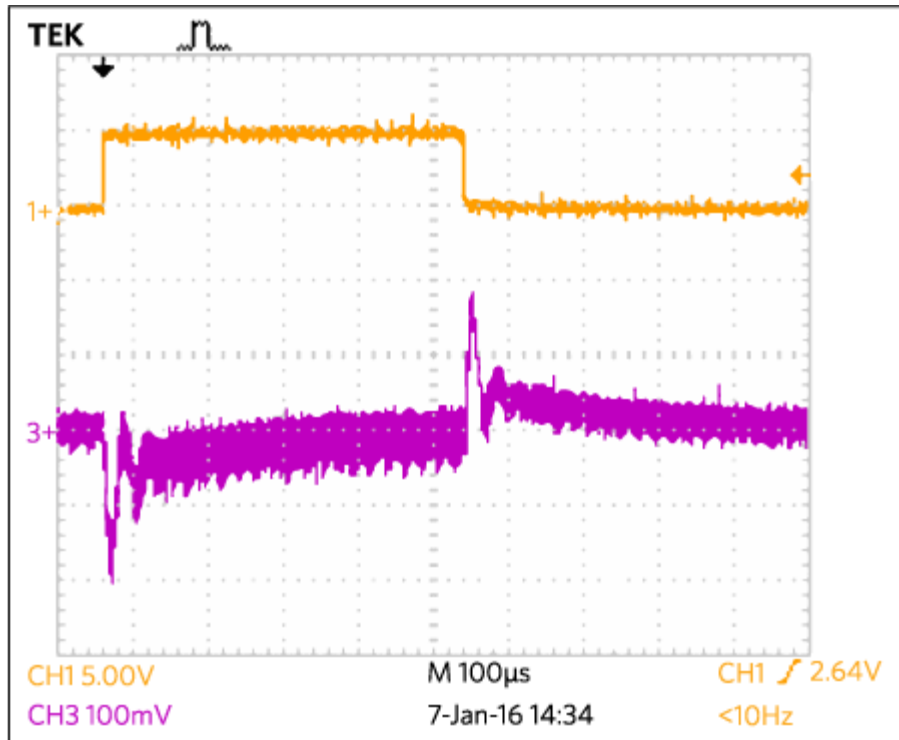
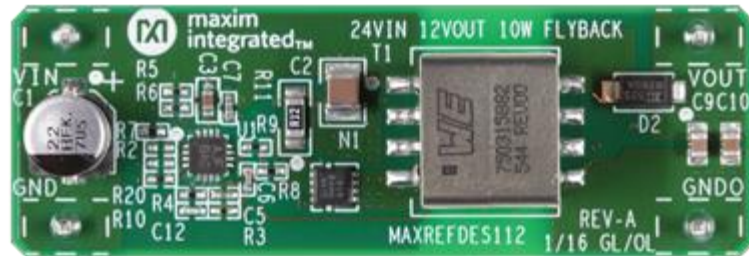

Figure 5. Transient

response when load steps from 480mA to 800mA.

Part Number



[MAXREFDES112A#](#)

[Enlarge+](#)

Transformer Vendor

Würth

Transformer Part Number

750315882

Part Number

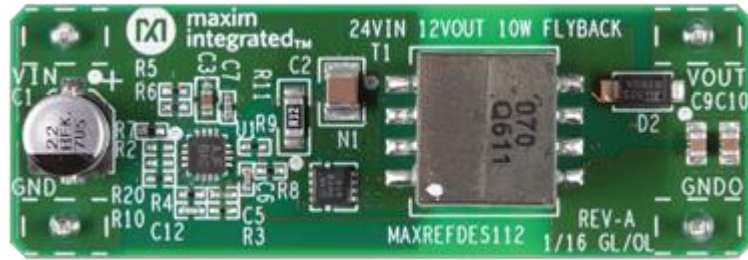

[MAXREFDES112B#](#)

[Enlarge+](#)

Transformer Vendor

Sumida

Transformer Part Number

12387T070

Part Number



[MAXREFDES112C#](#)

[Enlarge+](#)

Transformer Vendor

Hanrun

Transformer Part Number

HR051075

Part Number



[MAXREFDES112D#](#)

[Enlarge+](#)

Transformer Vendor

Halo

Transformer Part Number
TGSP-P145EP10LF

Quick Start

Required equipment:

- MAXREFDES112# board
- One 24V DC power supply
- One electronic load
- 1 voltmeters
- 1 ammeters