

Silicon Carbide (SiC) Schottky Diode – EliteSiC, 20 A, 1200 V, D1, D2PAK-2L

FFSB20120A-F085

Description

Silicon Carbide (SiC) Schottky Diodes use a completely new technology that provides superior switching performance and higher reliability compared to Silicon. No reverse recovery current, temperature independent switching characteristics, and excellent thermal performance sets Silicon Carbide as the next generation of power semiconductor. System benefits include highest efficiency, faster operating frequency, increased power density, reduced EMI, and reduced system size and cost.

Features

- Max Junction Temperature 175°C
- Avalanche Rated 200 mJ
- High Surge Current Capacity
- Positive Temperature Coefficient
- Ease of Paralleling
- No Reverse Recovery/No Forward Recovery
- AEC-Q101 qualified

Applications

- Automotive HEV-EV Onboard Chargers
- Automotive HEV-EV DC-DC Converters

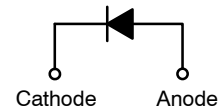

Schottky Diode

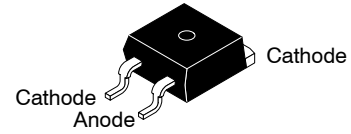

D²PAK2 (TO-263-2L)
 CASE 418BK

MARKING DIAGRAM

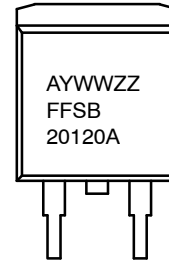

- A = Assembly Plant Code
- YWW = Date Code (Year & Week)
- ZZ = Lot Code
- FFSB20120A = Specific Device Code

ORDERING INFORMATION

See detailed ordering and shipping information on page 2 of this data sheet.

FFSB20120A-F085

ABSOLUTE MAXIMUM RATINGS (T_C = 25°C unless otherwise noted)

Symbol	Parameter	Ratings	Unit	
V _{RRM}	Peak Repetitive Reverse Voltage	1200	V	
E _{AS}	Single Pulse Avalanche Energy (Note 1)	200	mJ	
I _F	Continuous Rectified Forward Current @ T _C < 157°C	20	A	
	Continuous Rectified Forward Current @ T _C < 135°C	32		
I _{F, Max}	Non-Repetitive Peak Forward Surge Current	T _C = 25°C, 10 μs	1190	A
		T _C = 150°C, 10 μs	990	
I _{F, SM}	Non-Repetitive Forward Surge Current	Half-Sine Pulse, tp = 8.3 ms	135	A
I _{F, RM}	Repetitive Forward Surge Current	Half-Sine Pulse, tp = 8.3 ms	74	A
P _{tot}	Power Dissipation	T _C = 25°C	333	W
		T _C = 150°C	55	W
T _J , T _{STG}	Operating and Storage Temperature Range	-55 to +175	°C	

Stresses exceeding those listed in the Maximum Ratings table may damage the device. If any of these limits are exceeded, device functionality should not be assumed, damage may occur and reliability may be affected.

THERMAL CHARACTERISTICS

Symbol	Parameter	Ratings	Unit
R _{θJC}	Thermal Resistance, Junction to Case, Max	0.45	°C/W

PACKAGE MARKING AND ORDERING INFORMATION

Part Number	Top Mark	Package	Shipping [†]
FFSB20120A-F085	FFSB20120A	D2PAK2	800 Units/ Tape & Reel

[†]For information on tape and reel specifications, including part orientation and tape sizes, please refer to our Tape and Reel Packaging Specifications Brochure, BRD8011/D.

ELECTRICAL CHARACTERISTICS (T_C = 25°C unless otherwise noted)

Symbol	Parameter	Test Conditions	Min	Typ.	Max.	Unit
V _F	Forward Voltage	I _F = 20 A, T _C = 25°C	-	1.45	1.75	V
		I _F = 20 A, T _C = 125°C	-	1.7	2	
		I _F = 20 A, T _C = 175°C	-	2	2.4	
I _R	Reverse Current	V _R = 1200 V, T _C = 25°C	-	-	200	μA
		V _R = 1200 V, T _C = 125°C	-	-	300	
		V _R = 1200 V, T _C = 175°C	-	-	400	
Q _C	Total Capacitive Charge	V = 800 V	-	120	-	nC
C	Total Capacitance	V _R = 1 V, f = 100 kHz	-	1220	-	pF
		V _R = 400 V, f = 100 kHz	-	111	-	
		V _R = 800 V, f = 100 kHz	-	88	-	

Product parametric performance is indicated in the Electrical Characteristics for the listed test conditions, unless otherwise noted. Product performance may not be indicated by the Electrical Characteristics if operated under different conditions.

- E_{AS} of 200 mJ is based on starting T_J = 25°C, L = 0.5 mH, I_{AS} = 29 A, V = 50 V.

TYPICAL CHARACTERISTICS ($T_C = 25^\circ\text{C}$ unless otherwise noted)

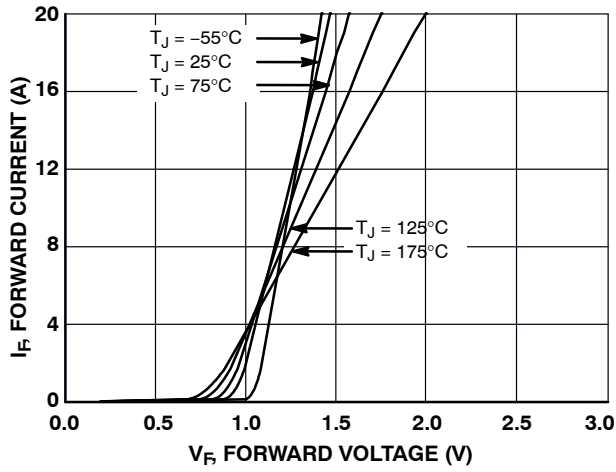

Figure 1. Forward Characteristics

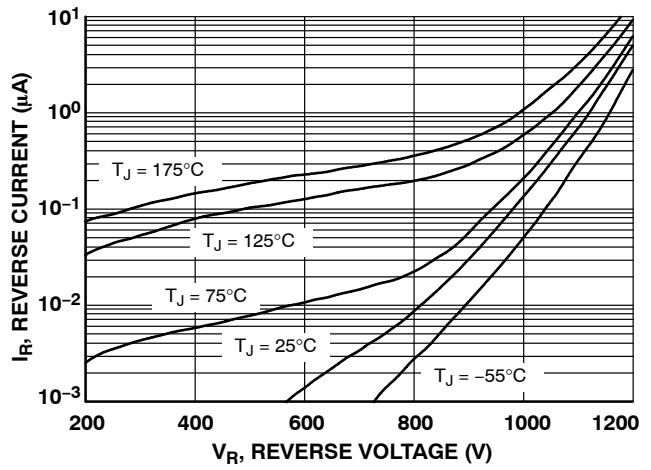

Figure 2. Reverse Characteristics

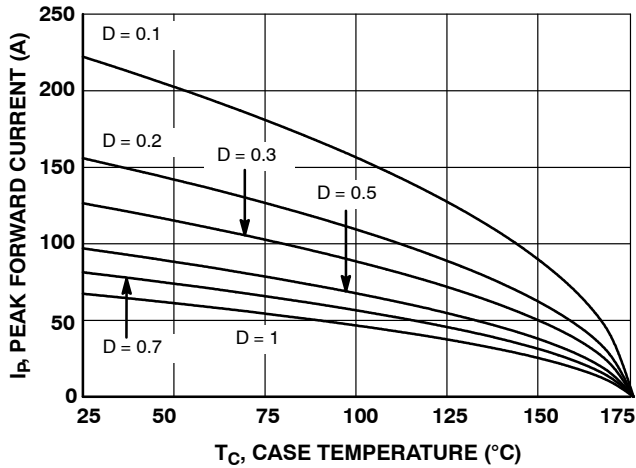

Figure 3. Current Derating

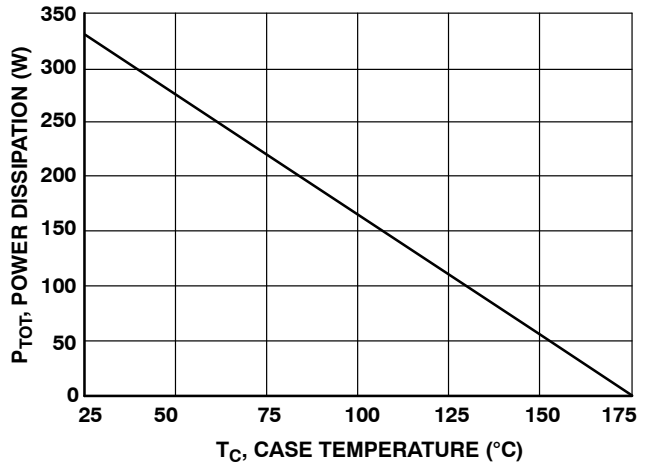

Figure 4. Power Derating

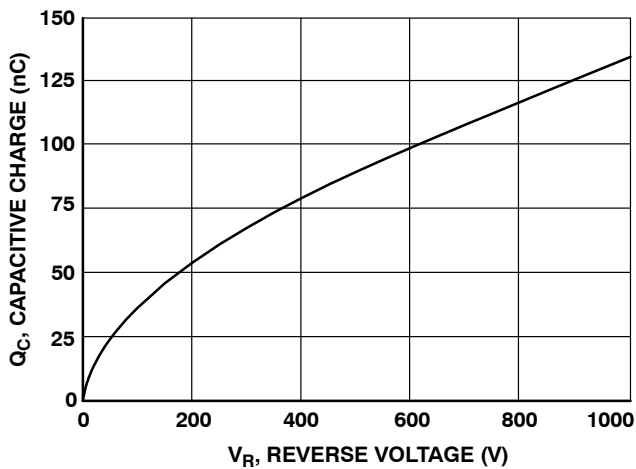

Figure 5. Capacitive Charge vs. Reverse Voltage

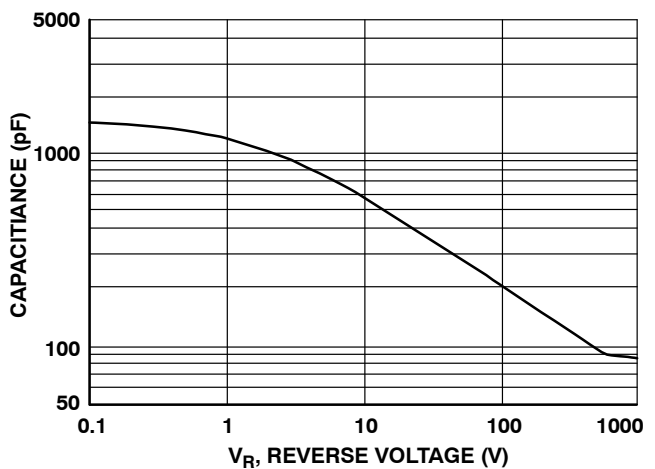

Figure 6. Capacitive Charge vs. Reverse Voltage

TYPICAL CHARACTERISTICS ($T_C = 25^\circ\text{C}$ unless otherwise noted) (continued)

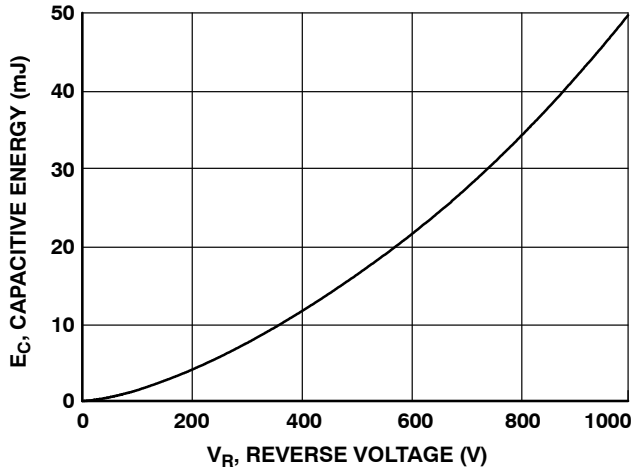

Figure 7. Capacitance Stored Energy

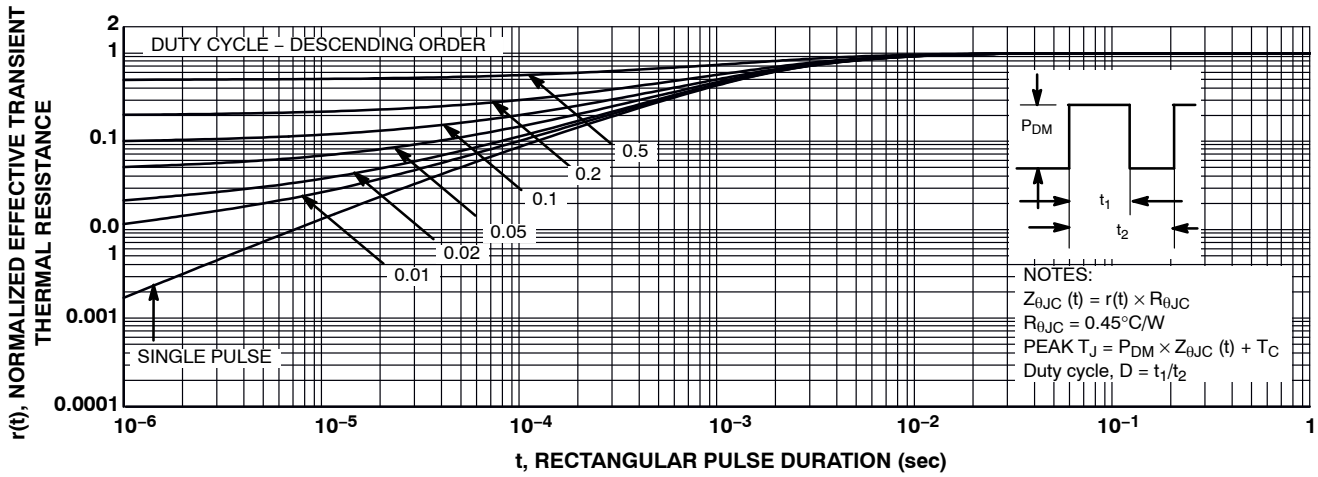

Figure 8. Junction-to-Case Transient Thermal Response Curve

TEST CIRCUIT AND WAVEFORMS

$L = 0.5 \text{ mH}$
 $R < 0.1 \Omega$
 $V_{DD} = 50 \text{ V}$
 $E_{AVL} = 1/2LI^2 [V_{R(AVL)} / (V_{R(AVL)} - V_{DD})]$
 $Q1 = \text{IGBT (} BV_{CES} > \text{DUT } V_{R(AVL)})$

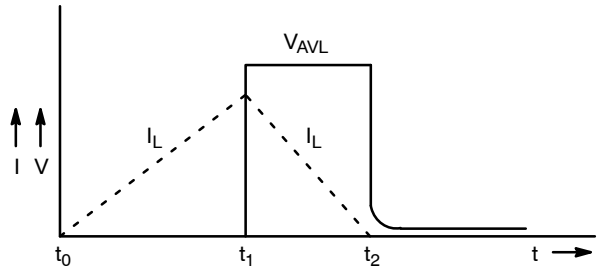
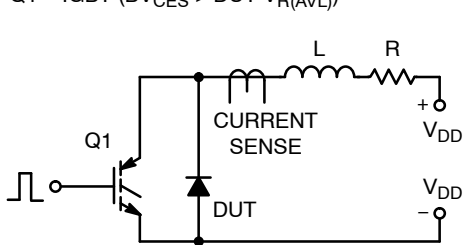

Figure 9. Unclamped Inductive Switching Test Circuit & Waveform

MECHANICAL CASE OUTLINE

PACKAGE DIMENSIONS



D²PAK2 (TO-263-2L)
CASE 418BK
ISSUE O

DATE 02 AUG 2018



DETAIL A, ROTATED 90°
 SCALE: 2X

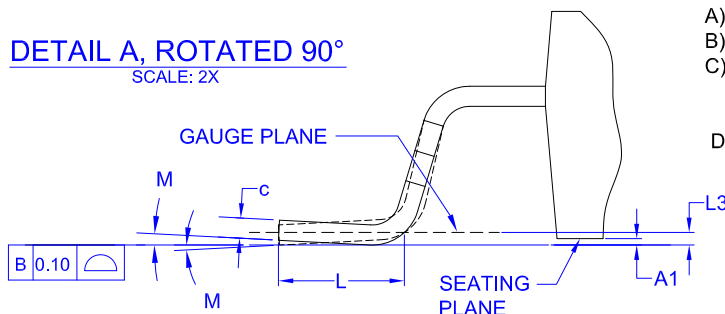

NOTES: UNLESS OTHERWISE SPECIFIED
 A) ALL DIMENSIONS ARE IN MILLIMETERS.
 B) REFERENCE JEDEC, TO-263, VARIATION AB.
 C) DIMENSIONING AND TOLERANCING PER DIMENSIONING AND TOLERANCING PER ASME Y14.5 - 2009.
 D) LANDPATTERN RECOMMENDATION PER IPC TO254P1524X482-3N

DIM	MILLIMETERS		
	MIN	NOM	MAX
A	4.06	4.57	4.83
A1	0.00	0.10	0.25
b	0.51	0.81	0.99
c	0.30	0.407	0.74
c2	1.14	1.30	1.65
D	8.38	8.69	9.65
D1	7.30	7.80	8.30
E	9.65	10.16	10.67
E1	8.00	8.62	9.00
e	5.08 BSC		
H	14.60	15.35	15.88
L	1.78	2.54	2.79
L1	0.90	1.29	1.68
L2	0.00	0.15	0.25
L3	0.25 BSC		
M	0°	4°	8°

GENERIC MARKING DIAGRAM*

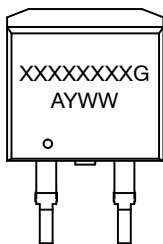

XXX = Specific Device Code
 A = Assembly Location
 Y = Year
 WW = Work Week
 G = Pb-Free Package

*This information is generic. Please refer to device data sheet for actual part marking. Pb-Free indicator, "G" or microdot "▪", may or may not be present. Some products may not follow the Generic Marking.

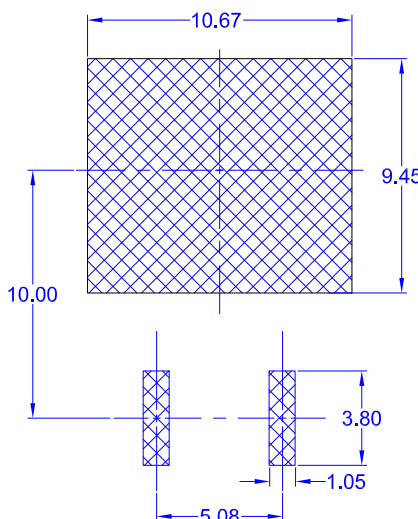

LAND PATTERN RECOMMENDATION
 UNLESS NOTED, ALL DIMS TYPICAL

DOCUMENT NUMBER:	98AON93788G	Electronic versions are uncontrolled except when accessed directly from the Document Repository. Printed versions are uncontrolled except when stamped "CONTROLLED COPY" in red.
DESCRIPTION:	D²PAK2 (TO-263-2L)	PAGE 1 OF 1

onsemi and ONSEMI are trademarks of Semiconductor Components Industries, LLC dba onsemi or its subsidiaries in the United States and/or other countries. onsemi reserves the right to make changes without further notice to any products herein. onsemi makes no warranty, representation or guarantee regarding the suitability of its products for any particular purpose, nor does onsemi assume any liability arising out of the application or use of any product or circuit, and specifically disclaims any and all liability, including without limitation special, consequential or incidental damages. onsemi does not convey any license under its patent rights nor the rights of others.

onsemi, **Onsemi**, and other names, marks, and brands are registered and/or common law trademarks of Semiconductor Components Industries, LLC dba "**onsemi**" or its affiliates and/or subsidiaries in the United States and/or other countries. **onsemi** owns the rights to a number of patents, trademarks, copyrights, trade secrets, and other intellectual property. A listing of **onsemi**'s product/patent coverage may be accessed at www.onsemi.com/site/pdf/Patent-Marking.pdf. **onsemi** reserves the right to make changes at any time to any products or information herein, without notice. The information herein is provided "as-is" and **onsemi** makes no warranty, representation or guarantee regarding the accuracy of the information, product features, availability, functionality, or suitability of its products for any particular purpose, nor does **onsemi** assume any liability arising out of the application or use of any product or circuit, and specifically disclaims any and all liability, including without limitation special, consequential or incidental damages. Buyer is responsible for its products and applications using **onsemi** products, including compliance with all laws, regulations and safety requirements or standards, regardless of any support or applications information provided by **onsemi**. "Typical" parameters which may be provided in **onsemi** data sheets and/or specifications can and do vary in different applications and actual performance may vary over time. All operating parameters, including "Typicals" must be validated for each customer application by customer's technical experts. **onsemi** does not convey any license under any of its intellectual property rights nor the rights of others. **onsemi** products are not designed, intended, or authorized for use as a critical component in life support systems or any FDA Class 3 medical devices or medical devices with a same or similar classification in a foreign jurisdiction or any devices intended for implantation in the human body. Should Buyer purchase or use **onsemi** products for any such unintended or unauthorized application, Buyer shall indemnify and hold **onsemi** and its officers, employees, subsidiaries, affiliates, and distributors harmless against all claims, costs, damages, and expenses, and reasonable attorney fees arising out of, directly or indirectly, any claim of personal injury or death associated with such unintended or unauthorized use, even if such claim alleges that **onsemi** was negligent regarding the design or manufacture of the part. **onsemi** is an Equal Opportunity/Affirmative Action Employer. This literature is subject to all applicable copyright laws and is not for resale in any manner.

PUBLICATION ORDERING INFORMATION

LITERATURE FULFILLMENT:

Email Requests to: orderlit@onsemi.com

onsemi Website: www.onsemi.com

TECHNICAL SUPPORT

North American Technical Support:

Voice Mail: 1 800-282-9855 Toll Free USA/Canada

Phone: 011 421 33 790 2910

Europe, Middle East and Africa Technical Support:

Phone: 00421 33 790 2910

For additional information, please contact your local Sales Representative