



Part no.: 50104783
BPS 8 SM 102-01
Bar code positioning system



Figure can vary

Contents

- Technical data
- Dimensioned drawings
- Electrical connection
- Diagrams
- Operation and display
- Part number code
- Accessories

Technical data

Basic data	
Series	BPS 8
Data telegram	Binary protocol 1
Order guide	Bar code tape must be ordered separately
Optical data	
Depth of field	80 ... 140 mm
Light source	Laser , Red
Laser class	2 , IEC/EN 60825-1:2007
Light beam exit	Front
Measurement data	
Measurement range	0 ... 10,000,000 mm
Resolution	0.001 ... 100 mm
Measurement value output	3.3 ms
Max. traverse rate	4 m/s
Electrical data	
Protective circuit	Short circuit protected
Performance data	
Supply voltage U_B	4.9 ... 5.4 V , DC
Current consumption, max.	250 mA
Inputs/outputs selectable	
Output current, max.	100 mA
Number of inputs/outputs selectable	1 Piece(s)
Interface	
Type	RS 232
RS 232	
Function	Process
Transmission speed	1,200 ... 187,500 Bd
Data format	Adjustable
Start bit	1
Data bit	8 data bits
Stop bit	1
Parity	Adjustable
Data encoding	Binary
Service interface	
Type	RS 232
RS 232	
Function	Service
Connection	
Number of connections	1 Piece(s)

Connection 1

Type of connection	Connector
Function	Connection to device
Thread size	M12
No. of pins	5 -pin

Mechanical data

Dimension (W x H x L)	15 mm x 48 mm x 40.3 mm
Housing material	Metal , Diecast zinc
Lens cover material	Glass
Net weight	70 g
Housing color	Red Silver
Type of fastening	Dovetail grooves Mounting thread Through-hole mounting Via optional mounting device

Operation and display

Type of display	LED
Number of LEDs	2 Piece(s)

Environmental data

Ambient temperature, operation	0 ... 40 °C
Ambient temperature, storage	-20 ... 60 °C
Relative humidity (non-condensing)	0 ... 90 %

Certifications

Degree of protection	IP 67 , EN 60529 with various connectors or screwed-on caps
Protection class	III
Certifications	c UL US
US patents	US 6,822,774 B

Classification

Customs tariff number	84719000
eCl@ss 8.0	27280190
eCl@ss 9.0	27280190
ETIM 5.0	EC001825
ETIM 6.0	EC001825

Dimensioned drawings

All dimensions in millimeters

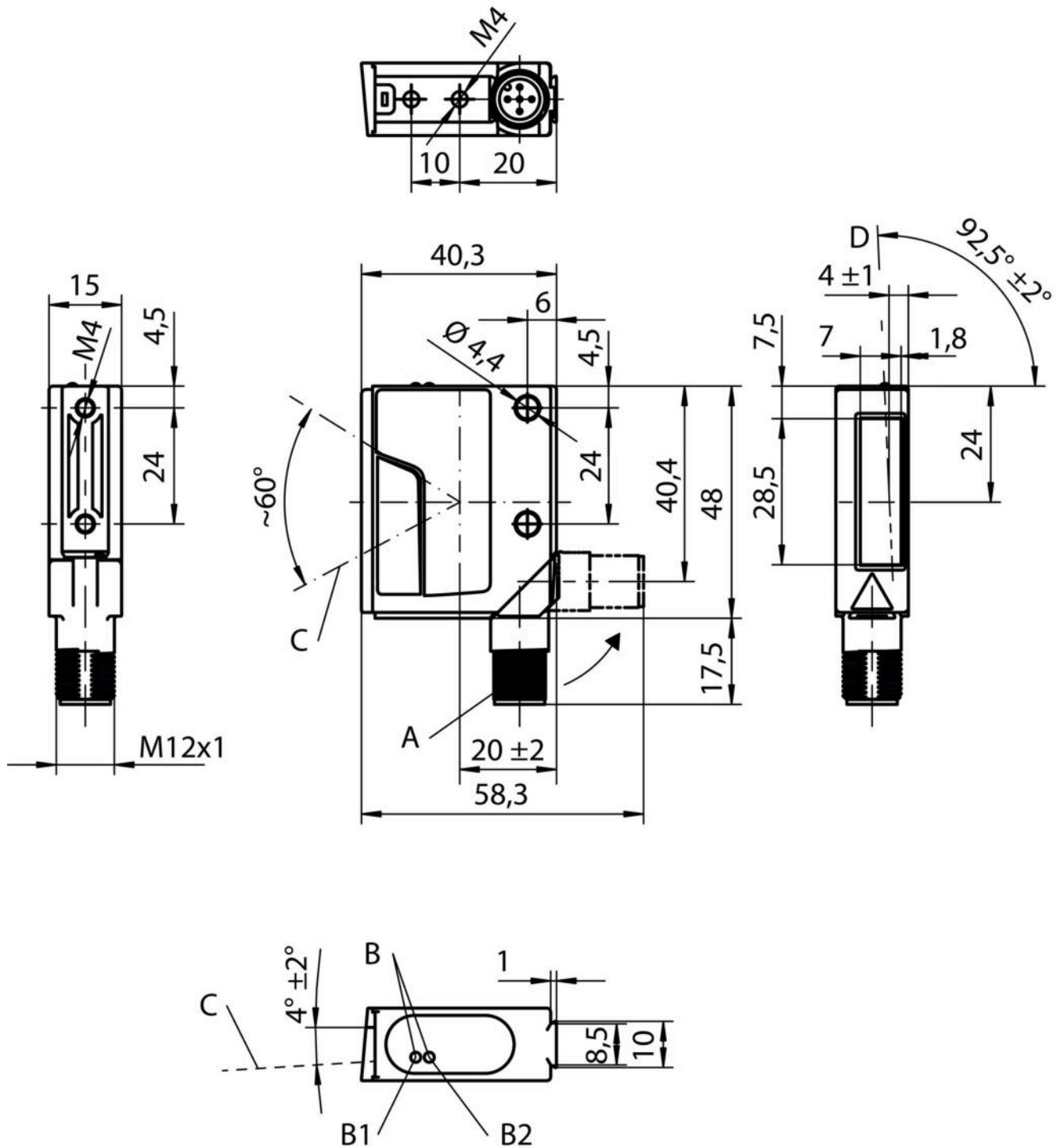

- A Turning connector, turnable by 90°
- B Indicator diodes (B1: status LED, B2: decode LED)
- C Scanning beam, divergence max. 5 mm at 150 mm reading distance
- D Optical axis

Electrical connection

Connection 1	
Type of connection	Connector

Part no.: 50104783 – BPS 8 SM 102-01 – Bar code positioning system

Connection 1	
Function	Connection to device
Thread size	M12
Type	Male
Material	Metal
No. of pins	5 -pin
Encoding	A-coded

Pin	Pin assignment
1	V+
2	RS 232 TxD
3	GND
4	RS 232 RxD
5	SW IN/OUT

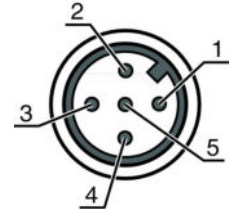

Diagrams

Reading field curve

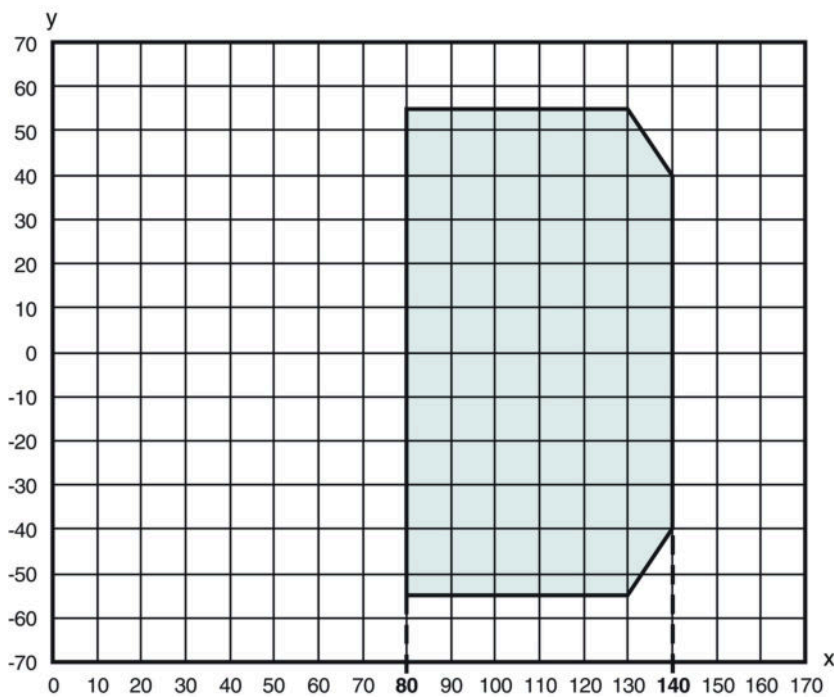

x Reading distance [mm]
y Reading field width [mm]
Gray Working range

Operation and display

LEDs

LED	Display	Meaning
1	Off	No supply voltage
	Green, flashing	Device ok, initialization phase
	Green, continuous light	Operational readiness
	Red, flashing	Device OK, warning set
	Red, continuous light	Device error
	Orange, flashing	Service operation active
2	Off	Positioning deactivated
	Green, continuous light	Positioning running (position value valid)
	Red, continuous light	Positioning running (position value invalid)
	Orange, continuous light	Positioning running (marker label detected)

Part number code

 Part designation: **BPS 8 XX YYY - ZZ**



XX	Scanning principle / optics: S: line scanner (single line) M: Medium Density (medium distance)
YYY	Beam exit: 100: lateral 102: front
ZZ	Presetting: 01 / 05: Binary protocol 1 02: Binary protocol 2 03: Binary protocol 3 04: Binary protocol 4 10: Binary protocol 6

Note

 A list with all available device types can be found on the Leuze electronic website at www.leuze.com.

Accessories

Connection technology - Connection unit

	Part no.	Designation	Article	Description
	50112891	MA 248i Profinet Gateway	Modular connection unit	Supply voltage: 18 ... 30 V Current consumption, max.: 300 mA Interface: PROFINET, RS 232 Connections: 6 Piece(s) Degree of protection: IP 65
	50104790	MA 8-01	Modular connection unit	Supply voltage: 10 ... 30 V Current consumption, max.: 50 mA Interface: RS 485 Connections: 3 Piece(s) Degree of protection: IP 67

Part no.: 50104783 – BPS 8 SM 102-01 – Bar code positioning system

Connection technology - Connection cables

	Part no.	Designation	Article	Description
	50040757	KB 008-3000 A	Connection cable	Connection 1: Connector, M12, Axial, Female, A-coded, 5 -pin Connection 2: Open end Shielded: Yes Cable length: 3,000 mm Sheathing material: PUR

Connection technology - Interconnection cables

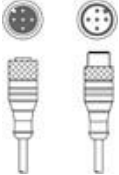
	Part no.	Designation	Article	Description
	50113467	KB JST-M12A-5P-3000	Connection cable	Suitable for interface: RS 232 Connection 1: Connector, M12, Axial, Female, A-coded, 5 -pin Connection 2: JST ZHR, 12 -pin Shielded: Yes Cable length: 3,000 mm Sheathing material: PUR
	50133890	KDS S-M12-5A-M12-5A-P1-020	Interconnection cable	Connection 1: Connector, M12, Axial, Female, A-coded, 5 -pin Connection 2: Connector, M12, Axial, Male, A-coded, 5 -pin Shielded: Yes Cable length: 2,000 mm Sheathing material: PUR

Mounting technology - Rod mounts

	Part no.	Designation	Article	Description
	50127177	BTU 008M-D10	Mounting system	Design of mounting device: Mounting system Fastening, at system: Sheet-metal mounting, For 10 mm rod Mounting bracket, at device: Screw type Type of mounting device: Turning, 360°, Adjustable, Clampable Material: Metal

Mounting technology - Other

	Part no.	Designation	Article	Description
	50104791	BT 8-01	Mounting device	Fastening, at system: Through-hole mounting Mounting bracket, at device: Screw type Material: Metal

Part no.: 50104783 – BPS 8 SM 102-01 – Bar code positioning system

Bar code tape

	Part no.	Designation	Article	Description
	50104792	BCB 8 010	Bar code tape	Dimensions: 47 mm x 10,000 mm Grid dimension: 30 mm

Note

A list with all available accessories can be found on the Leuze electronic website in the Download tab of the article detailed page.