

MDT0400E1IS-RGB	480 x 480	RGB Interface	TFT Module
<b>Specification</b>			
Version: 1		Date: 20/12/2018	
<b>Revision</b>			
1	18/12/2018	First issue	

Display Features			
Display Size	4.0"		
Resolution	480 x 480		
Orientation	Square		
Appearance	RGB		
Logic Voltage	3.3V		
Interface	RGB		
Brightness	350 cd/m <sup>2</sup>		
Touchscreen	--		
Module Size	77.66 x 78.97 x 2.30 mm		
Operating Temperature	-20°C ~ +70°C		
Pinout	45 way FFC		Box Quantity
Pitch	0.3 mm		Weight / Display

\* - For full design functionality, please use this specification in conjunction with the ST7701-G5 specification.(Provided Separately)

Display Accessories	
Part Number	Description

Optional Variants	
Appearances	Voltage



## General Specifications

	Feature	Spec
Characteristics	Size	4.0 inch
	Resolution	480(horizontal)*480(Vertical)
	Interface	RGB-24bit
	Connect type	Connector
	Display Colors	16.7M
	Technology type	a-Si
	Pixel pitch (mm)	0.149*0.146
	Pixel Configuration	R.G.B-Stripe
	Display Mode	Normally Black
	LCD Driver IC	ST7701-G5
	Viewing Direction	Full view
Mechanical	LCM (W x H x D) (mm)	77.66*78.97*2.3
	Active Area(mm)	71.86 x70.18
	With /Without TSP	Without TSP
	Weight (g)	TBD
	LED Numbers	10 LEDs

Note 1: Requirements on Environmental Protection: RoHs

Note 2: LCM weight tolerance: +/- 5%

design • manufacture • supply



## Input/Output Terminals

No.	Symbol	Description
1	GND	Ground
2	VLED+	Backlight LED Anode.
3	VLED-	Backlight LED Cathode
4	VCC	Power supply 3.3V
5	IOVCC	Power supply 1.8V
6	SDO	Serial output signal
7	SDI	Serial Data Input
8	GND	Ground
9	SCL-WR	Serial Clock
10	CS	Chip select pin
11	NC	No connect
12	RESET	Reset signal pin
13~20	R0~R7	Data bus
21~28	G0~G7	Data bus
29~36	B0~B7	Data bus
37	DE	Data enable input. Active high to enable the input data bus under "DE Mode."
38	GND	Ground
39	PCLK	Dot clock signal input. Latching input data at its rising edge.
40	GND	Ground
41	HSYNC	Horizontal sync input. Negative polarity.
42	VSYNC	Vertical sync input. Negative polarity..
43	IC-ID	No connect
44	LED-PWM	The PWM frequency output for LCD driver control.
45	GND	Ground



## Absolute Maximum Rating

Item	Symbol	MIN	Typ	MAX	Unit	Remark
Supply Voltage	VDD	-0.5	-	5	V	-
Operating Temperature	TOPR	-20	-	70	°C	-
Storage Temperature	TSTG	-30	-	80	°C	-

## Electrical Characteristics

### Driving TFT LCD Panel

Item	Symbol	MIN	TYP	MAX	Unit	Remark
Supply Voltage	VDD	3.0	3.3	3.6	V	
Input Signal Voltage	Low Level	V <sub>IL</sub>	GND	-	0.3x VDD	V
	High Level	V <sub>IH</sub>	0.7x VDD	-	VDD	V
Output Signal Voltage	Low Level	V <sub>IL</sub>	GND	-	VDD+0.4	V
	High Level	V <sub>IH</sub>	VDD-0.4	-	VDD	V
(Panel+LSI) Power Consumption	Black Mode (60Hz)	-	74	-	nW	
	Standby	-	50	-	uW	

Item	Symbol	Min.	Typ.	Max.	Unit	Note
TFT Gate ON Voltage	V <sub>GH</sub>	--	(15)	--	V	*1,*2
TFT Gate OFF Voltage	V <sub>GL</sub>	--	(-10)	--	V	
TFT Common Voltage	V <sub>com</sub>	--	(0)	--	V	
Data (RGB signal) Voltage	V <sub>sig</sub>	(-5)	--	(5)	V	

Note:

\*1. V<sub>GH</sub> is TFT Gate operating Voltage.

\*2. V<sub>GL</sub> is TFT Gate operating Voltage.

The storage structure of this model is C<sub>ST</sub>(Storage on Common)

\*3. V<sub>com</sub> must be adjusted to optimize display quality \_ Cross talk, Contrast Ratio and etc.

### LED Driving Conditions

Item	Symbol	MIN	TYP	MAX	Unit	Remark
Forward Current <sup>5</sup>	I <sub>F</sub>	-	40	-	mA	
Forward Voltage	V <sub>F</sub>	14..4	15	15.6	V	
Backlight Power consumption	W <sub>BL</sub>	-	0.6	-	W	
LED Lifetime		-	30000	-	Hrs	



Note 1: Each LED:  $I_F = 20 \text{ mA}$ ,  $V_F = 3.2 \pm 0.2 \text{ V}$ .

Note 2: Optical performance should be evaluated at  $T_a = 25^\circ \text{C}$  only.

Note 3: If LED is driven by high current, high ambient temperature & humidity condition. The life Time of LED will be reduced. Operating life means brightness goes down to 50% initial brightness. Typical operating life time is estimated data.



Figure: LED connection of backlight(Constant Current)

### Block Diagram

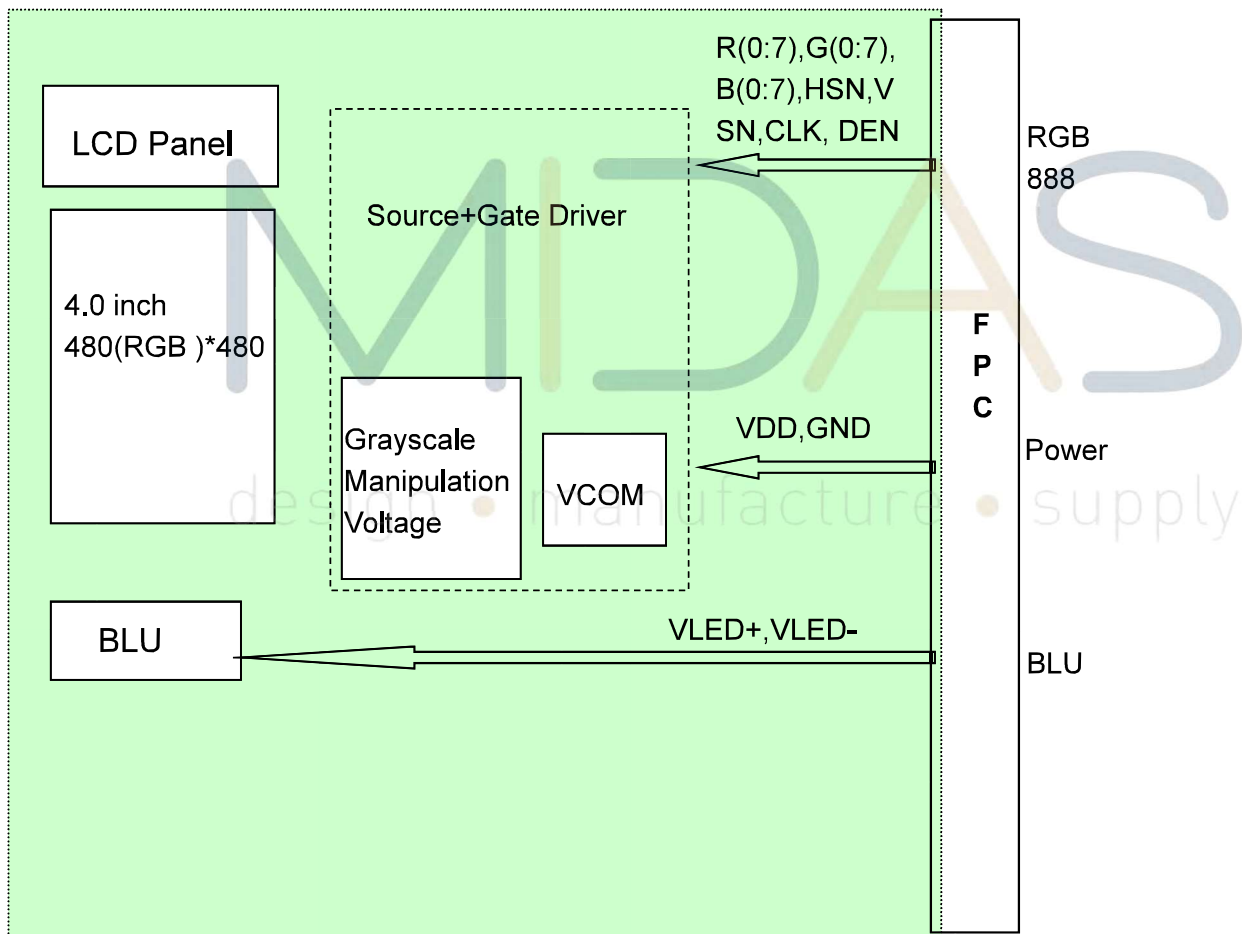

## Interface Timing

### Serial Interface Characteristics (3-line serial):

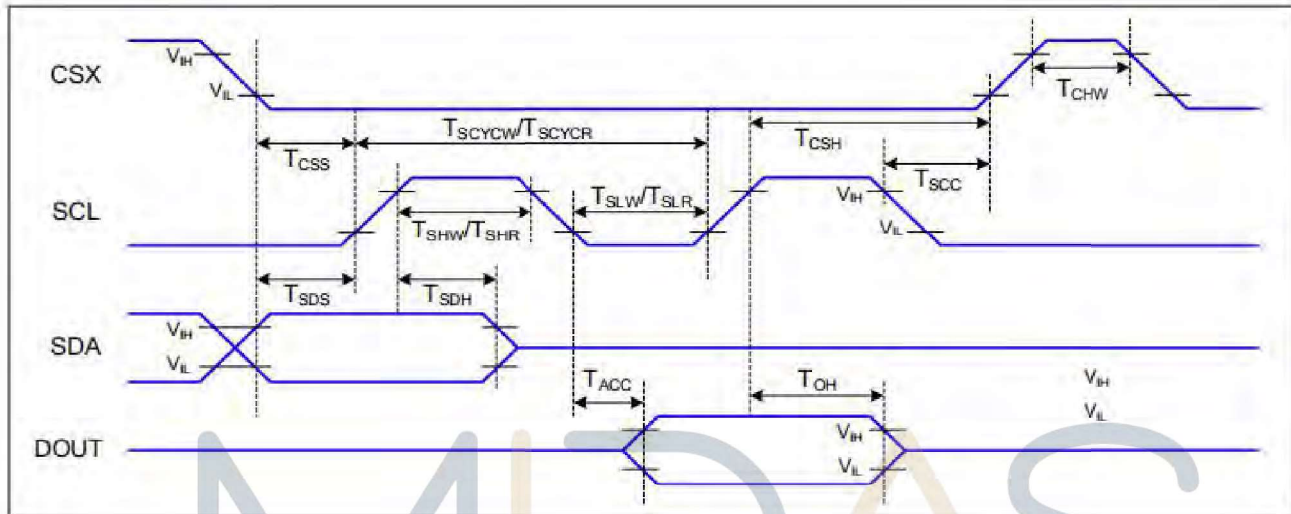

### 3-line serial Interface Timing Characteristics

Signal	Symbol	Parameter	Min	Max	Unit	Description
CSX	T <sub>CSS</sub>	Chip select setup time (write)	15		ns	Supply
	T <sub>CSH</sub>	Chip select hold time (write)	15		ns	
	T <sub>CSS</sub>	Chip select setup time (read)	60		ns	
	T <sub>SCC</sub>	Chip select hold time (read)	60		ns	
	T <sub>CHW</sub>	Chip select "H" pulse width	40		ns	
SCL	T <sub>SCYCW</sub>	Serial clock cycle (Write)	66		ns	
	T <sub>SHW</sub>	SCL "H" pulse width (Write)	15		ns	
	T <sub>SLW</sub>	SCL "L" pulse width (Write)	15		ns	
	T <sub>SCYCR</sub>	Serial clock cycle (Read)	150		ns	
	T <sub>SHR</sub>	SCL "H" pulse width (Read)	60		ns	
	T <sub>SLR</sub>	SCL "L" pulse width (Read)	60		ns	
SDA (DIN)	T <sub>SDS</sub>	Data setup time	10		ns	
	T <sub>SDH</sub>	Data hold time	10		ns	

## Serial Interface Characteristics (4-line serial):

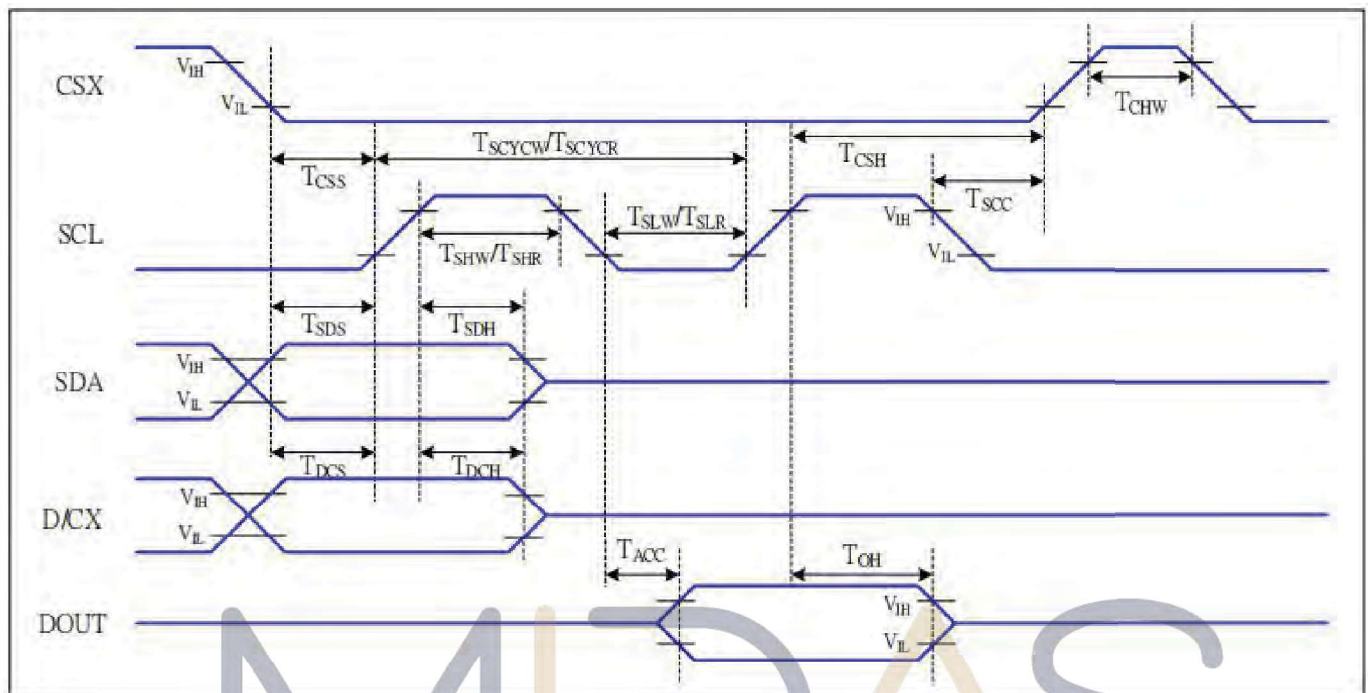

## 4-line serial Interface Timing Characteristics

Signal	Symbol	Parameter	MIN	MAX	Unit	Description
CSX	$T_{CSS}$	Chip select setup time (write)	15		ns	
	$T_{CSH}$	Chip select hold time (write)	15		ns	
	$T_{CSS}$	Chip select setup time (read)	60		ns	
	$T_{SCC}$	Chip select hold time (read)	65		ns	
	$T_{CHW}$	Chip select "H" pulse width	40		ns	
SCL	$T_{SCYCW}$	Serial clock cycle (Write)	66		ns	-write command & data ram
	$T_{SHW}$	SCL "H" pulse width (Write)	15		ns	
	$T_{SLW}$	SCL "L" pulse width (Write)	15		ns	
	$T_{SCYCR}$	Serial clock cycle (Read)	150		ns	-read command & data ram
	$T_{SHR}$	SCL "H" pulse width (Read)	60		ns	
	$T_{SLR}$	SCL "L" pulse width (Read)	60		ns	
D/CX	$T_{DCS}$	D/CX setup time	10		ns	
	$T_{DCH}$	D/CX hold time	10		ns	
SDA (DIN)	$T_{SDS}$	Data setup time	10		ns	
	$T_{SDH}$	Data hold time	10		ns	

## RGB Interface Characteristics :

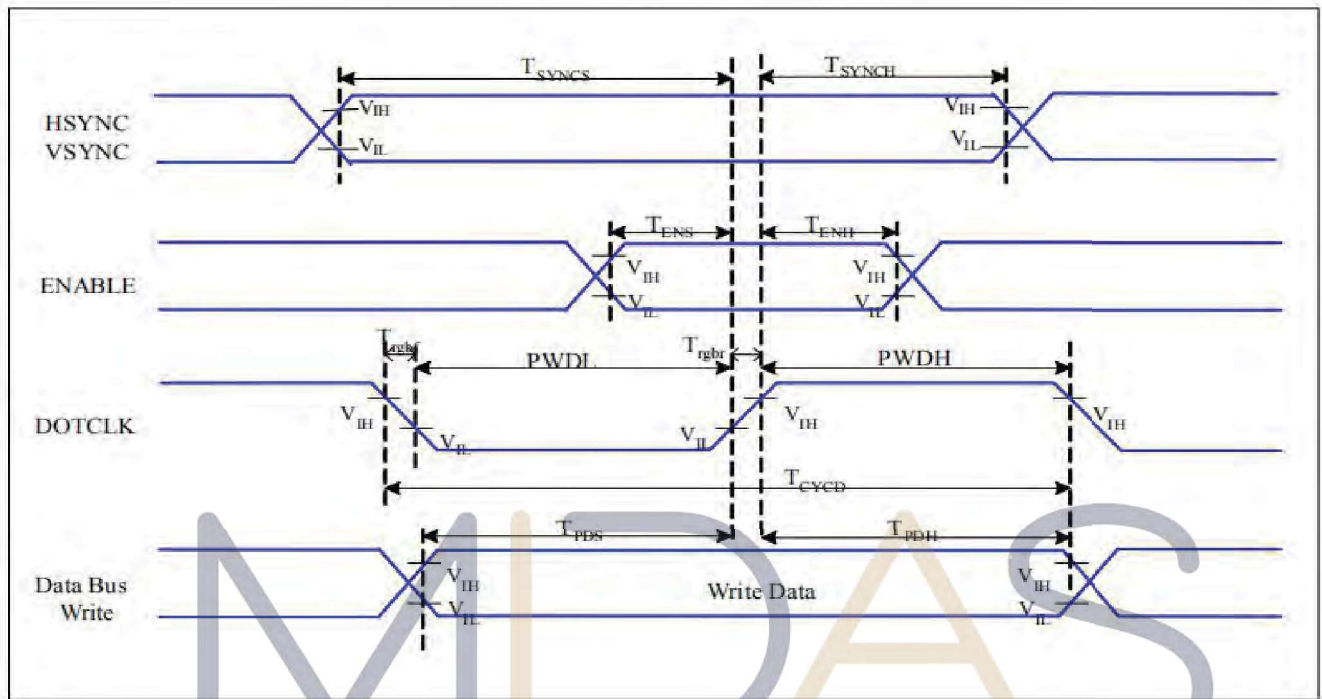

## RGB Interface Timing Characteristics

Signal	Symbol	Parameter	MIN	MAX	Unit	Description
HSYNC, VSYNC	T <sub>SYNCS</sub>	VSYNC, HSYNC Setup Time	5	-	ns	
ENABLE	T <sub>ENS</sub>	Enable Setup Time	5	-	ns	
	T <sub>ENH</sub>	Enable Hold Time	5	-	ns	
DOTCLK	PWDH	DOTCLK High-level Pulse Width	15	-	ns	
	PWDL	DOTCLK Low-level Pulse Width	15	-	ns	
	T <sub>CycD</sub>	DOTCLK Cycle Time	33	-	ns	
	Trghr, Trghf	DOTCLK Rise/Fall time	-	15	ns	
DB	T <sub>PDS</sub>	PD Data Setup Time	5	-	ns	
	T <sub>PDH</sub>	PD Data Hold Time	5	-	ns	





The timing chart of RGB interface DE mode is shown as follows.

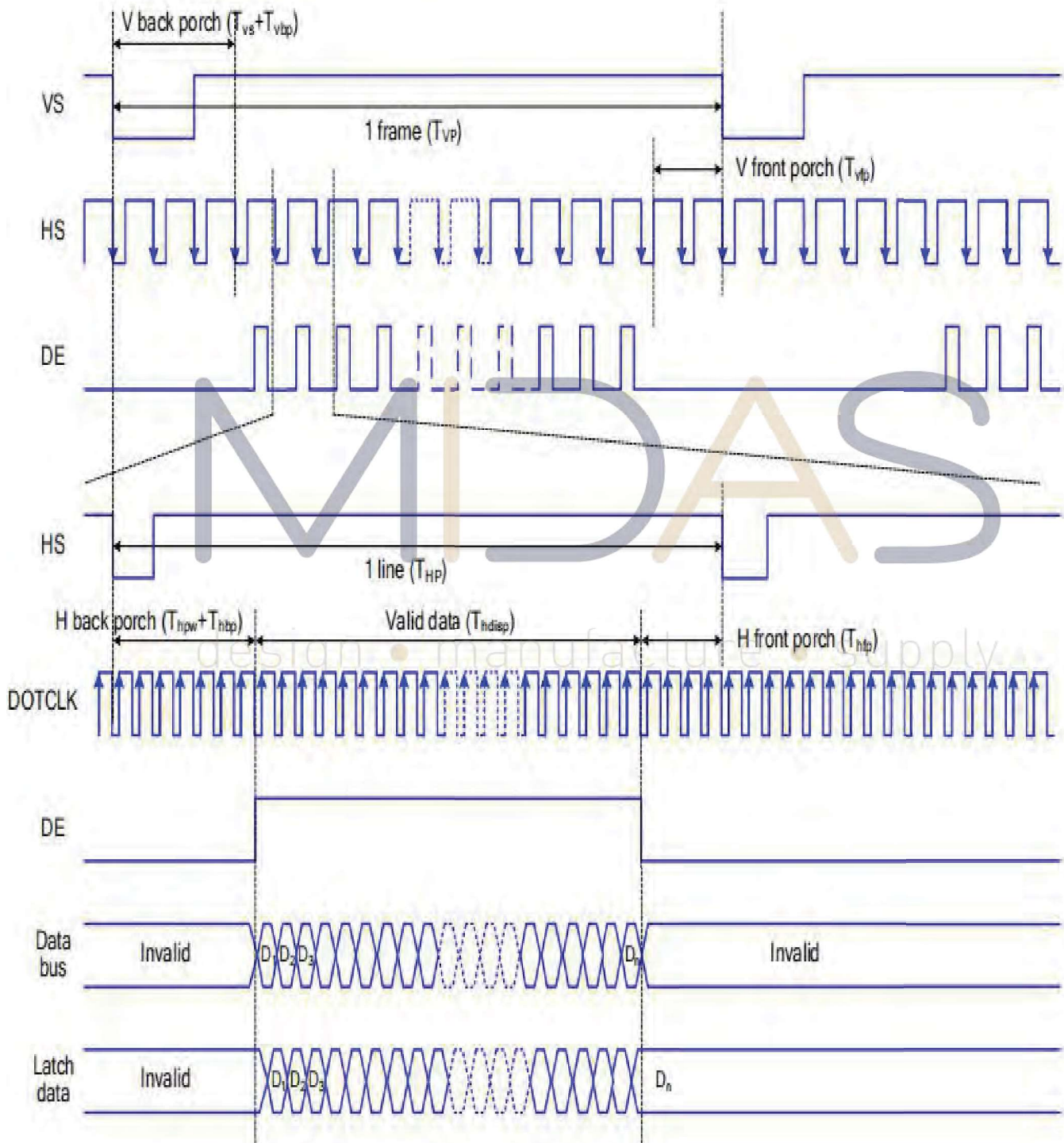

The timing chart of RGB interface HV mode is shown as follows

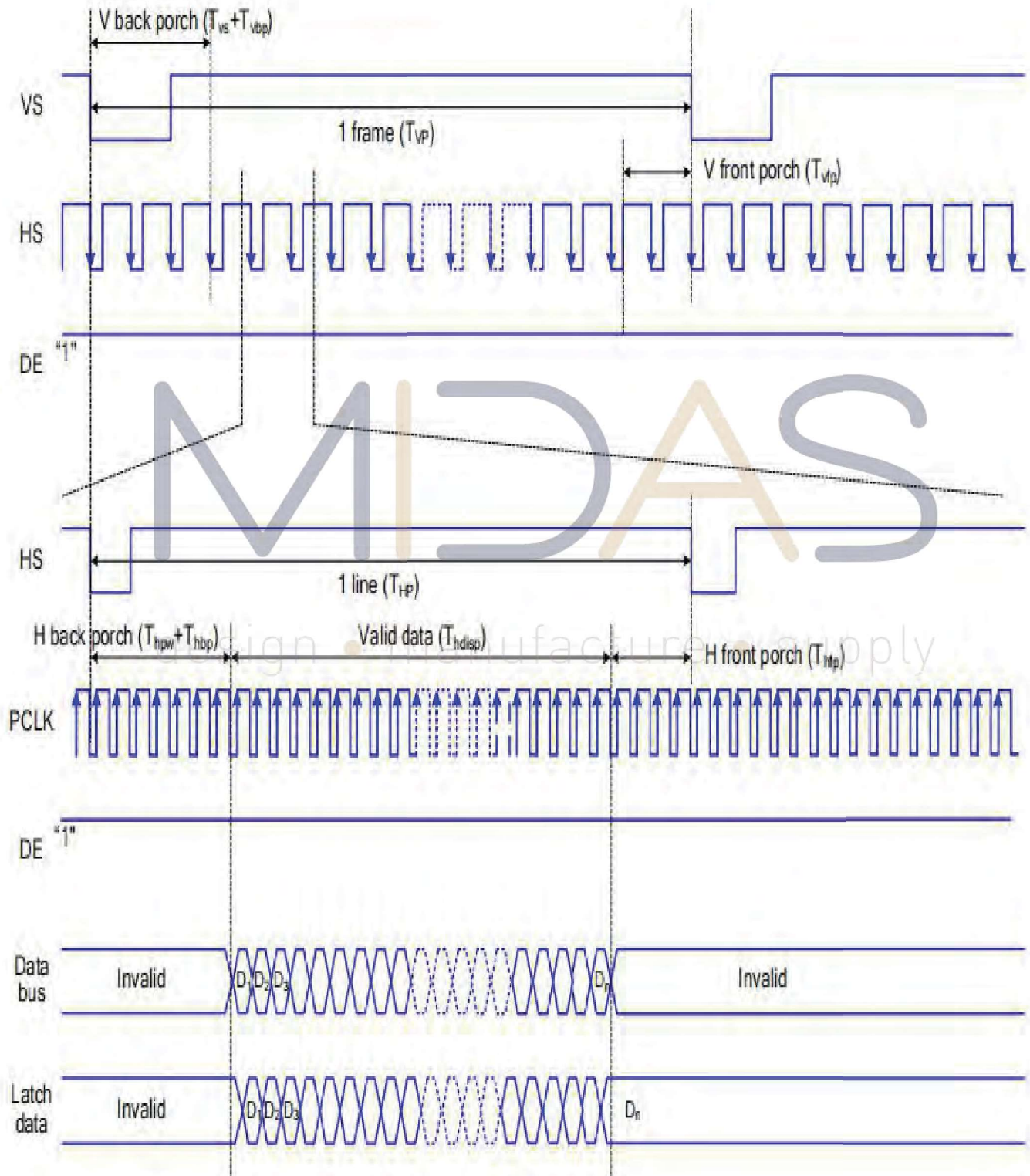

## Optical Characteristics

Items	Symbol	Condition	Min.	Typ.	Max.	Unit	Remark	Note
Response time	Tr+Tf	-	-	25	35	ms	FIG.1	Note4
Contrast Ratio	CR		500	700	-	-	FIG.2	Note1
Surface luminance	LV	$\theta = 0^\circ$	-	350	-	cd/m2	FIG.2	Note2
Luminance uniformity	Yu	$\theta = 0^\circ$	55	60	-	%	FIG.2	Note3
NTSC	-	$\theta = 0^\circ$	-	50	-	%	FIG.2	Note5
Viewing angle	$\theta_T$	Center CR $\geq$ 10	-	80	-	deg	FIG.3	Note6
	$\theta_B$		-	80	-	deg	FIG.3	
	$\theta_L$		-	80	-	deg	FIG.3	
	$\theta_R$		-	80	-	deg	FIG.3	
Chromaticity	Red	$R_X$	0.5784	0.6284	0.6784	-	FIG.2 CIE1931	Note5
		$R_Y$	0.3046	0.3546	0.4046	-		
	Green	$G_X$	0.2914	0.3414	0.3914	-		
		$G_Y$	0.5068	0.5568	0.6068	-		
	Blue	$B_X$	0.0952	0.1452	0.1952	-		
		$B_Y$	0.0297	0.0797	0.1298	-		
	White	$W_X$	0.2511	0.3011	0.3511	-		
		$W_Y$	0.2526	0.3026	0.3526	-		

design • manufacture • supply

### Note1. Definition of contrast ratio

Contrast ratio(Cr) is defined mathematically by the following formula. For more information see FIG.2.

$$\text{Contrast ratio} = \frac{\text{Luminance measured when LCD on the "White" state}}{\text{Luminance measured when LCD on the "Black" state}}$$

For contrast ratio, Surface Luminance, Luminance uniformity and CIE, the testing data is based on TOPCON's BM-5 or BM-7 photo detector or compatible.

### Note2. Definition of surface luminance.

Surface luminance is the luminance with all pixels displaying white. For more information see FIG.2.

Lv = Average Surface Luminance with all white pixels (P1, P2, P3, ....., Pn)

### Note3. Definition of luminance uniformity

The luminance uniformity in surface luminance is determined by measuring luminance at each test position 1 through n, and then dividing the maximum luminance of n points luminance by minimum luminance of n points luminance. For more information see FIG.2.

$$YU = \frac{\text{Minimum surface luminance with all white pixels (P1, P2, P3, ....., Pn)}}{\text{Maximum surface luminance with all white pixels (P1, P2, P3, ....., Pn)}}$$



**Note4. Definition of response time**

The response time is defined as the LCD optical switching time interval between “White” state and “Black”state. Rise time ( $T_r$ ) is the time between photo detector output intensity changed from 90% to 10%. And fall time ( $T_f$ ) is the time between photo detector output intensity changed from 10% to 90%.

For additional information see FIG1.

**Note5. Definition of color chromaticity (CIE1931)**

CIE (x,y) chromaticity, The x,y value is determined by screen active area center position P5. For more information see FIG.2.

**Note6. Definition of viewing angle**

Viewing angle is the angle at which the contrast ratio is greater than 10. Angles are determined for the horizontal or x axis and the vertical or y axis with respect to the z axis which is normal to the LCD surface. For more information see FIG.3.

For viewing angle and response time testing, the testing data is base on Autronic-Melchers’ s ConoScope or DMS series Instruments or compatible.

**FIG.1. The definition of response Time**

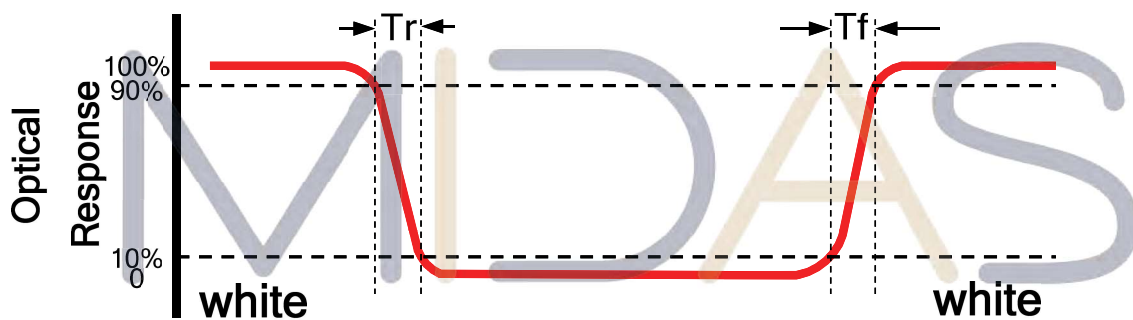

**FIG.2. Measuring method for contrast ratio, surface luminance,**

**luminance uniformity, CIE (x,y) chromaticity**

Size :  $S \leq 5"$  (see Figure a) A : 5 mm B : 5 mm

H,V : Active area

Light spot size  $\varnothing = 5\text{mm}$  (BM-5) or  $\varnothing = 7.7\text{mm}$  (BM-7) 50cm distance or compatible distance from the LCD surface to detector lens.

test spot position : see Figure a.

measurement instrument : TOPCON's luminance meter BM-5 or BM-7 or compatible (see Figure c).

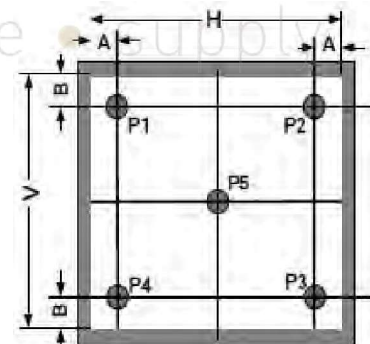

Figure a





Size :  $5'' < S \leq 12.3''$  (see Figure b) H,V : Active area

Light spot size  $\varnothing=5\text{mm}$  (BM-5) or  $\varnothing=7.7\text{mm}$  (BM-7) 50cm distance or compatible distance from the LCD surface to detector lens.

test spot position : see Figure b.

measurement instrument : TOPCON's luminance meter BM-5 or BM-7 or compatible (see Figure c).

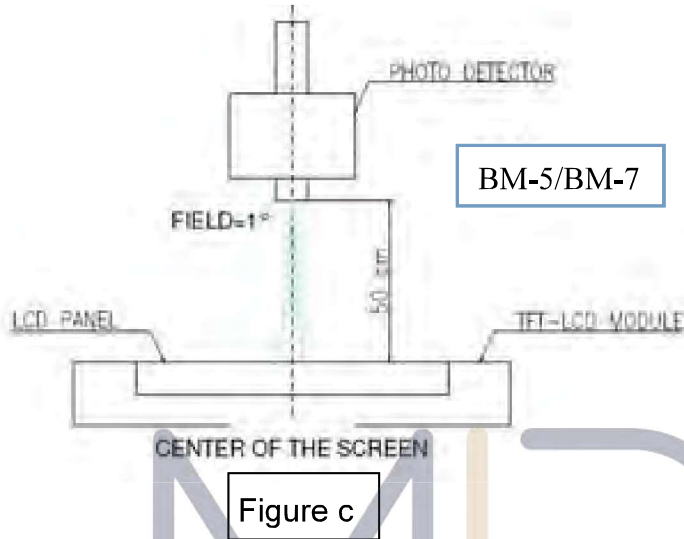
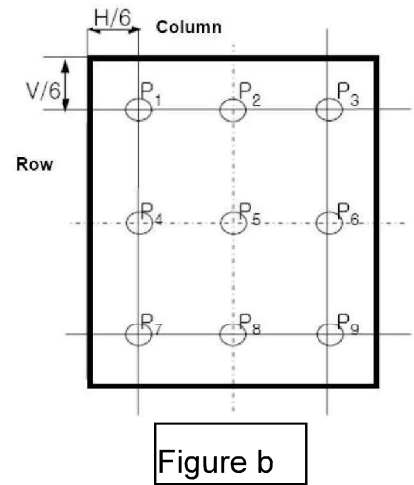
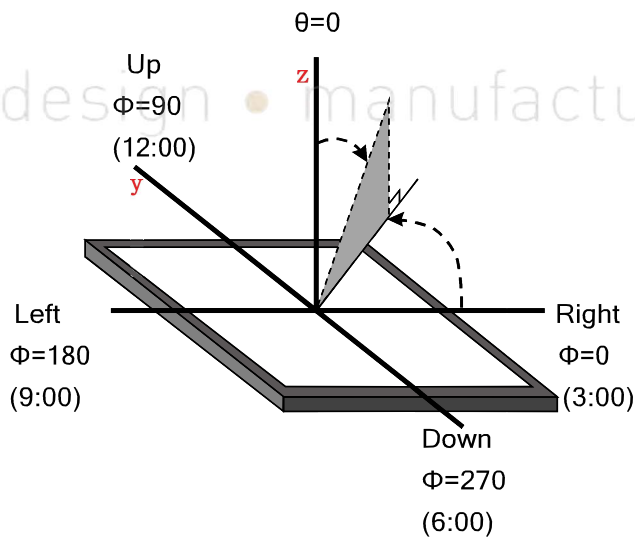

FIG.3. The definition of viewing angle



## Environmental / Reliability Tests

No	Test Item	Condition	Remarks
1	High Temperature Operation	Ts= +70°C, 96hrs	Note 1 IEC60068-2-2, GB2423. 2-89
2	Low Temperature Operation	Ta= -20°C, 96hrs	Note 2 IEC60068-2-1 GB2423.1-89
3	High Temperature Storage	Ta= +80°C, 96hrs	IEC60068-2-2 GB2423. 2-89
4	Low Temperature Storage	Ta= -30°C, 96hrs	IEC60068-2-1 GB/T2423.1-89
5	High Temperature & Humidity Storage	Ta= +70°C, 90% RH max,96 hours	IEC60068-2-3 GB/T2423.3-2006
6	Thermal Shock (Non-operation)	-20°C 30 min ~ +70°C 30 min Change time: 5min, 30 Cycle	Start with cold temperature, end with high temperature IEC60068-2-14, GB2423.22-87
7	Electro Static Discharge (Operation)	C=150pF, R=330 Ω, 5 points/panel Air:±8KV, 5 times; Contact: ±4KV, 5 times; (Environment: 15°C ~ 35°C, 30% ~ 60%, 86Kpa ~ 106Kpa)	IEC61000-4-2 GB/T17626.2-1998
8	Vibration (Non-operation)	Frequency range: 10~55Hz, Stroke: 1.mm Sweep: 10Hz~55Hz~10Hz 2 hours for each direction of X .Y. Z. (package condition)	IEC60068-2-6 GB/T2423.5-1995
9	Shock (Non-operation)	60G 6ms, ± X, ±Y , ± Z 3 times for each direction	IEC60068-2-27 GB/T2423.5-1995
10	Package Drop Test	Height: 80 cm, 1 corner, 3 edges, 6 surfaces	IEC60068-2-32 GB/T2423.8-1995

- Note: 1. Ts is the temperature of panel's surface.  
2. Ta is the ambient temperature of sample.  
3. The size of sample is 5pcs.



# Mechanical Drawing

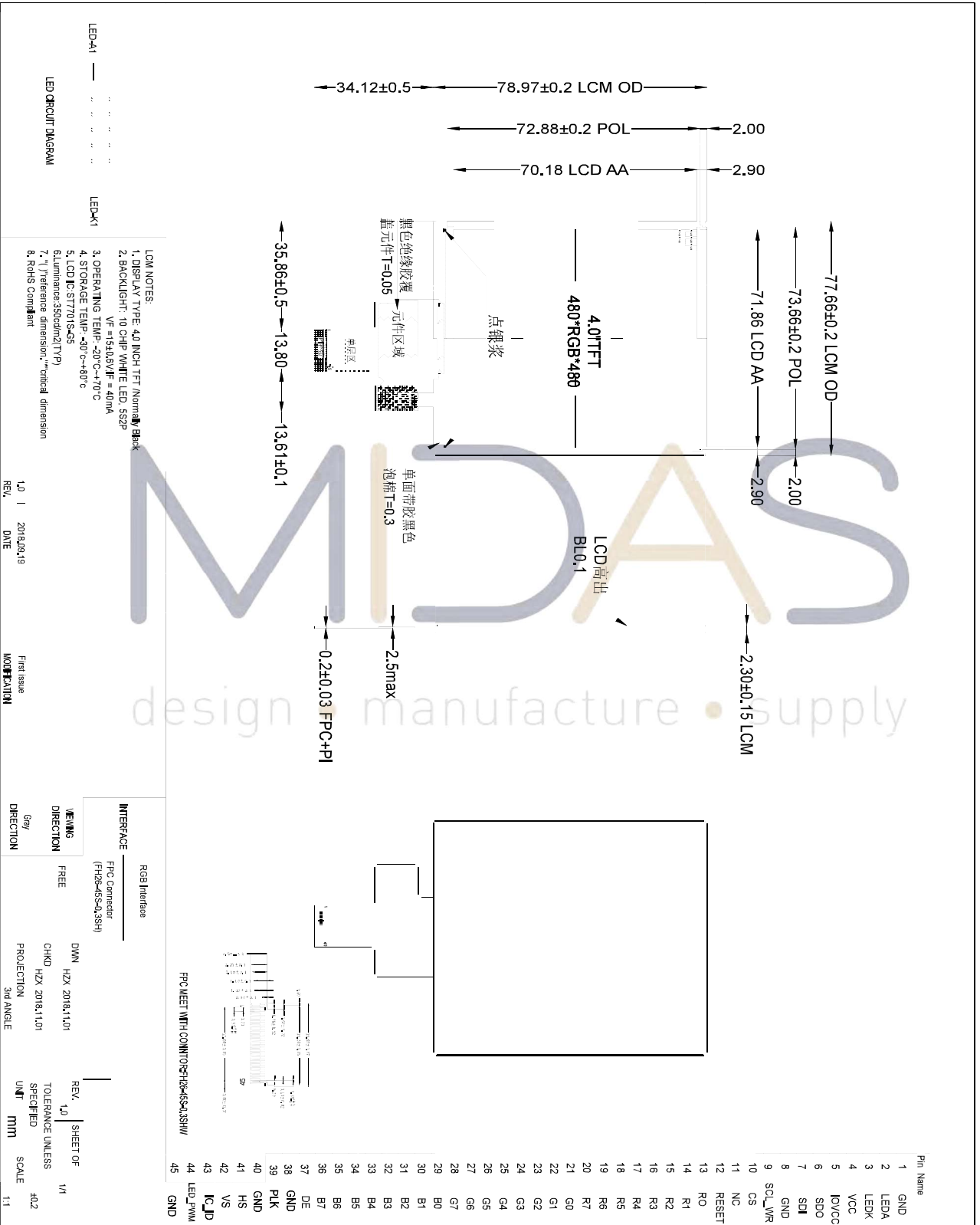

# TFT-LCD Module Inspection Criteria

## Scope

The incoming inspection standards shall be applied to TFT - LCD Modules (hereinafter Called "Modules") that supplied by Midas Displays.

## Incoming Inspection

The customer shall inspect the modules within twenty calendar days of the delivery date (the "inspection period") at its own cost. The result of the inspection (acceptance or rejection) shall be recorded in writing, and a copy of this writing will be promptly sent to The seller, If the results of the inspecting from buyer does not send to the seller within twenty Calendar days of the delivery date. The modules shall be regards as acceptance. Should the customer fail to notify the seller within the inspection period, the buyers Right to reject the modules shall be lapsed and the modules shall be deemed to have Been accepted by the buyer

## Inspection Sampling

- 3.1. Lot size: Quantity per shipment lot per model
- 3.2. Sampling type: Normal inspection, Single sampling
- 3.3. Inspection level: II
- 3.4. Sampling table: MIL-STD-105E
- 3.5. Acceptable quality level (AQL )  
Major defect: AQL=0.65 Minor defect: AQL=1.00

## Inspection Conditions

### 4.1 Ambient conditions:

- a. Temperature: Room temperature  $25 \pm 5^{\circ}\text{C}$
- b. Humidity:  $(60 \pm 10) \% \text{RH}$
- c. Illumination: Single fluorescent lamp non-directive (300 to 700 Lux)

### 4.2 Viewing distance

The distance between the LCD and the inspector's eyes shall be at least  $35 \pm 5$  cm.

### 4.3 Viewing Angle

U/D:  $45^{\circ} / 45^{\circ}$  , L/R:  $45^{\circ} / 45^{\circ}$



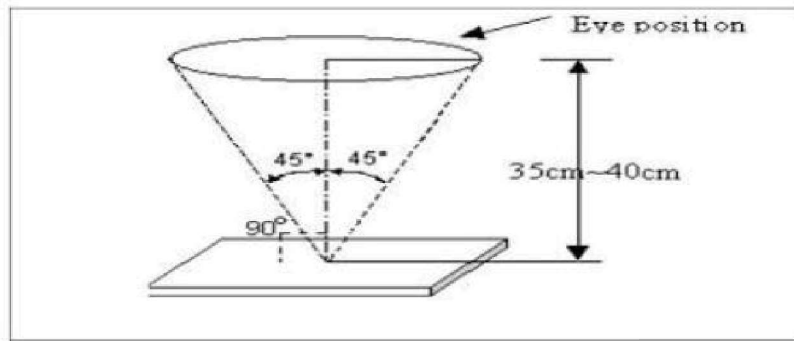

## Inspection Criteria

Defects are classified as major defects and minor defects according to the degree of Defectiveness defined herein.



### Major defect

Item No	Items to be inspected	Inspection Standard
5.1.1	All functional defects	1) No display 2) Display abnormally 3) Short circuit 4) line defect
5.1.2	Missing	Missing function component
5.1.3	Crack	Glass Crack

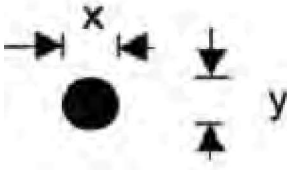
### Minor defect

Item No	Items to be inspected	Inspection standard	
5.2.1	Spot Defect Including Black spot White spot Pinhole Foreign particle Polarizer dirt	For dark/white spot is defined $\varphi = (x+y) / 2$ 	
		Size $\varphi$ (mm)	Acceptable Quantity
		$\varphi \leq 0.2$	Ignore
		$0.2 < \varphi \leq 0.5$	3
		$0.5 < \varphi$	Not allowed

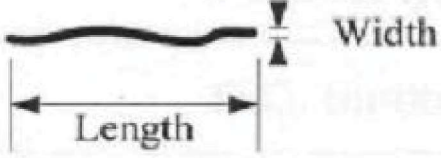

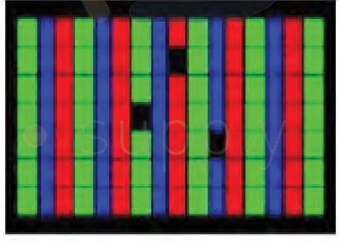
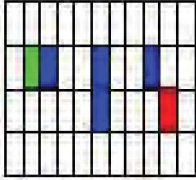
5.2.2	Line Defect Including Black line White line Scratch	Define:			
					
		Width(mm) Length(mm)		Acceptable Quantity	
		$W \leq 0.05$		Ignore	
		$0.05 < W \leq 0.1$ $L \leq 2.5$		3	
$0.1 < W$ , or $L > 2.5$		Not allowed			
5.2.3	Polarizer Dent/Bubble	Size $\phi$ (mm)		Acceptable Quantity	
		$\phi \leq 0.2$		Ignore	
		$0.2 < \phi \leq 0.3$		2	
		$0.3 < \phi \leq 0.5$		1	
		$0.5 < \phi$		Not allowed	
		Total QTY		3	
5.2.4	Electrical Dot Defect	Bright and Black dot define:			
					
		and			
					
		Two Adjacent Dot			
Inspection pattern: Full white, Full black, Red, green and blue screens					
Item			Acceptable Quantity		
			I	O	Note
Black dot defect			2		$\phi \leq 0.15$ (5mm $\leq$ Distance)
Bright dot defect			1		
Total Dot			1		

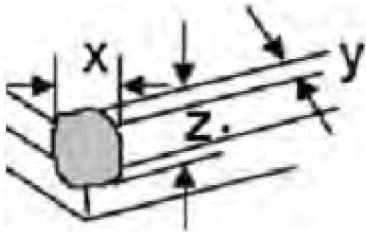
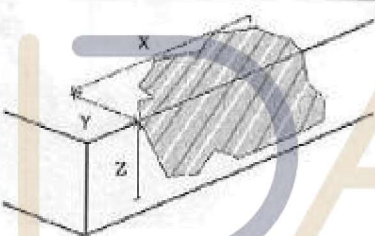

5.2.5	Glass defect	 <p><b>1. Corner Fragment:</b></p>	
		<b>Size(mm)</b>	<b>Acceptable Quantity</b>
		$X \leq 3\text{mm}$ $Y \leq 1\text{mm}$ $Z \leq T$	Ignore <b>T:</b> Glass thickness <b>X:</b> Length <b>Y:</b> Width <b>Z:</b> thickness
		<p><b>2. Side Fragment:</b></p> 	
		<b>Size(mm)</b>	<b>Acceptable Quantity</b>
$X \leq 5.0\text{mm}$ $Y \leq 1\text{mm}$ $Z \leq T$	<b>T:</b> Glass thickness <b>X:</b> Length <b>Y:</b> Width <b>Z:</b> thickness		

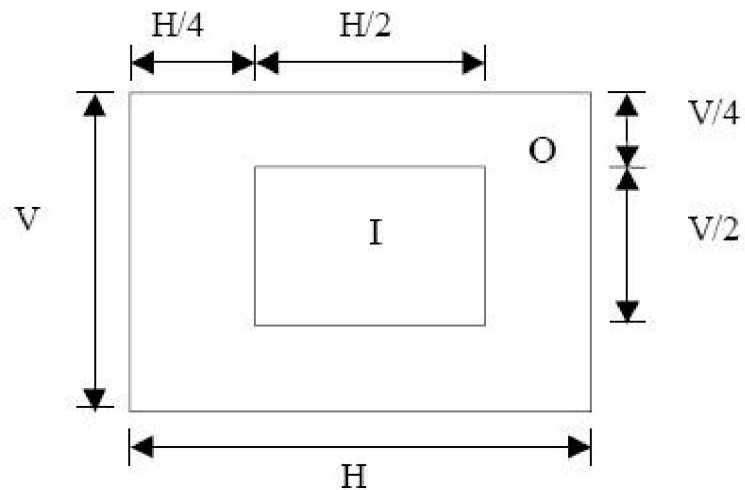

## I area & O area

- Note:
- 1). Dot defect is defined as the defective area of the dot area is larger than 50% of the dot area.
  - 2). The distance between two bright dot defects (red, green, blue, and white) should be larger than 15mm.
  - 3). The distance between black dot defects or black and bright dot defects should be more than 5mm apart.
  - 4). Polarizer bubble is defined as the bubble appears on active display area. The defect of polarizer bubble shall be ignored if the polarizer bubble appears on the outside of active display area.

### Mechanics specification

As for the outside dimension, weight of the modules, please refer to product specification  
For more details



## Precautions for Use of LCD modules

### Handling Precautions

- 1.1. The display panel is made of glass. Do not subject it to a mechanical shock by dropping it from a high place, etc.
- 1.2. If the display panel is damaged and the liquid crystal substance inside it leaks out, be sure not to get any in your mouth, if the substance comes into contact with your skin or clothes, promptly wash it off using soap and water.
- 1.3. Do not apply excessive force to the display surface or the adjoining areas since this may cause the color tone to vary.
- 1.4. The polarizer covering the display surface of the LCD module is soft and easily scratched. Handle this polarizer carefully.
- 1.5. If the display surface is contaminated, breathe on the surface and gently wipe it with a soft dry cloth. If still not completely clear, moisten cloth with one of the following solvents:
  - Isopropyl alcohol
  - Ethyl alcohol





Solvents other than those mentioned above may damage the polarizer. Especially, do not use the following:

- Water
- Ketene
- Aromatic solvents

1.6. Do not attempt to disassemble the LCD Module.

1.7. If the logic circuit power is off, do not apply the input signals.

1.8. To prevent destruction of the elements by static electricity, be careful to maintain an optimum work environment.

1.8.1. Be sure to ground the body when handling the LCD Modules.

1.8.2. Tools required for assembly, such as soldering irons, must be properly ground.

1.8.3. To reduce the amount of static electricity generated, do not conduct assembly and other work under dry conditions.

1.8.4. The LCD Module is coated with a film to protect the display surface. Be care when peeling off this protective film since static electricity may be generated.

### **Storage Precautions**

2.1. When storing the LCD modules, avoid exposure to direct sunlight or to the light of fluorescent lamps.

2.2. The LCD modules should be stored under the storage temperature range. If the LCD modules will be stored for a long time, the recommend condition is:

Temperature : 0°C ~ 40°C Relatively humidity: ≤80%

2.3. The LCD modules should be stored in the room without acid, alkali and harmful gas.

### **Transportation Precautions**

The LCD modules should be no falling and violent shocking during transportation, and also should avoid excessive press, water, damp and sunshine.

