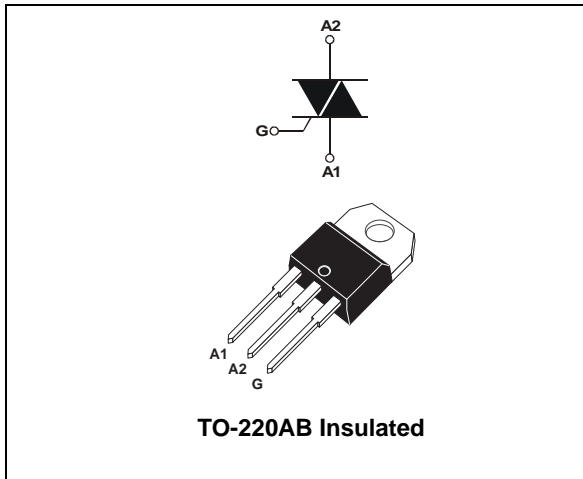

**20 A Snubberless™ Triacs**

Datasheet - production data

**Features**

- $I_{T(RMS)} = 20 \text{ A}$
- $V_{DRM}, V_{RRM} = 600 \text{ and } 700 \text{ V}$
- $I_{GT(Q1)} (\text{max}) = 35 \text{ and } 50 \text{ mA}$

**Description**

The BTA20 Triacs use high performance glass passivated chip technology. The Snubberless concept offers suppression of the RC network and is suitable for applications such as phase control and static switching on inductive or resistive load.

Thanks to their clip assembly technique, the BTA20 Triacs provide a superior performance in surge current handling capabilities.

By using an internal ceramic pad, the BTA series provides voltage insulated tab (rated at 2500 V rms) complying with UL standards (File ref.: E81734).

TM: Snubberless is a trademark of STMicroelectronics.

# 1 Characteristics

**Table 1. Absolute maximum ratings**

Symbol	Parameter		Value	Unit	
$I_{T(RMS)}$	On-state rms current (full sine wave)		$T_c = 70\text{ °C}$	20	A
$I_{TSM}$	Non repetitive surge peak on-state current (full cycle, $T_j$ initial = 25°C)	F = 50 Hz	t = 10 ms	210	A
		F = 60 Hz	t = 8.3 ms	200	
$I^2t$	$I^2t$ Value for fusing	$t_p = 10\text{ ms}$		200	A <sup>2</sup> s
dI/dt	Critical rate of rise of on-state current $I_G = 2 \times I_{GT}$ , $t_r \leq 100\text{ ns}$	Repetitive F = 50 Hz	$T_j = 125\text{ °C}$	50	A/μs
		Non repetitive		100	
$V_{DSM}$ , $V_{RSM}$	Non repetitive peak off-state voltage	$t_p = 10\text{ ms}$	$T_j = 25\text{ °C}$	$V_{DRM}/V_{RRM}$ 100	V
$I_{GM}$	Peak gate current	$t_p = 20\text{ μs}$	$T_j = 125\text{ °C}$	4	A
$V_{GM}$	Peak positive gate voltage	$t_p = 20\text{ μs}$		16	V
$P_{G(AV)}$	Average gate power dissipation		$T_j = 125\text{ °C}$	1	W
$T_{stg}$	Storage junction temperature range			- 40 to + 150	°C
$T_j$	Operating junction temperature range			- 40 to + 125	

**Table 2. Electrical characteristics ( $T_j = 25\text{ °C}$ , unless otherwise specified)**

Symbol	Test conditions	Quadrant		BTA20		Unit
				BW	CW	
$I_{GT}^{(1)}$	$V_D = 12\text{ V}$ , $R_L = 33\text{ Ω}$	ALL	Min.	2	1	mA
			Max.	50	35	
$V_{GT}$		ALL	Max.	1.5		V
$V_{GD}$	$V_D = V_{DRM}$ , $R_L = 3.3\text{ kΩ}$ , $T_j = 125\text{ °C}$	ALL	Min.	0.2		V
$I_H^{(2)}$	$I_T = 500\text{ mA}$ , gate open		Max.	75	50	mA
$I_L$	$I_G = 1.2 I_{GT}$	I - III	Typ.	50	-	mA
		II		90	-	
		I - II - III	Max.	-	80	
dV/dt <sup>(2)</sup>	$V_D = 67\% V_{DRM}$ , gate open	$T_j = 125\text{ °C}$	Typ.	750	500	V/μs
			Min.	500	250	
(dV/dt) <sub>C</sub> <sup>(2)</sup>	(dI/dt) <sub>C</sub> = 20 A/ms	$T_j = 125\text{ °C}$	Typ.	36	22	V/μs
			Min.	18	11	

1. Minimum  $I_{GT}$  is guaranteed at 5% of  $I_{GT}$  max.

2. For both polarities of A2 referenced to A1.

Table 3. Static characteristics

Symbol	Parameter			Value	Unit
$V_{TM}^{(1)}$	$I_{TM} = 28\text{ A}$ , $t_p = 380\ \mu\text{s}$	$T_j = 125\ ^\circ\text{C}$	Max.	1.70	V
$I_{DRM}$	$V_{DRM} = V_{RRM}$	$T_j = 125\ ^\circ\text{C}$	Max.	10	$\mu\text{A}$
$I_{RRM}$		$T_j = 125\ ^\circ\text{C}$		3	mA

1. For both polarities of A2 referenced to A1.

Table 4. Thermal resistances

Symbol	Parameter	Value	Unit
$R_{th(j-c)}$	Junction to case for AC	2.1	$^\circ\text{C/W}$
$R_{th(j-c)}$	Junction to case for DC	2.8	
$R_{th(j-a)}$	Junction to ambient	60	

Figure 1. Maximum power dissipation versus on-state rms current (full cycle)

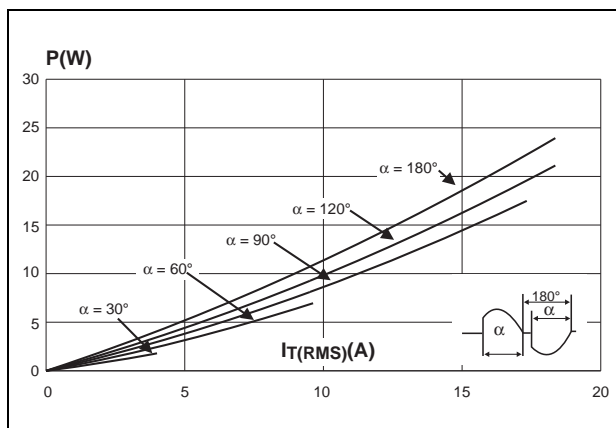

Figure 2. Correlation between maximum rms power dissipation and maximum allowable temperatures

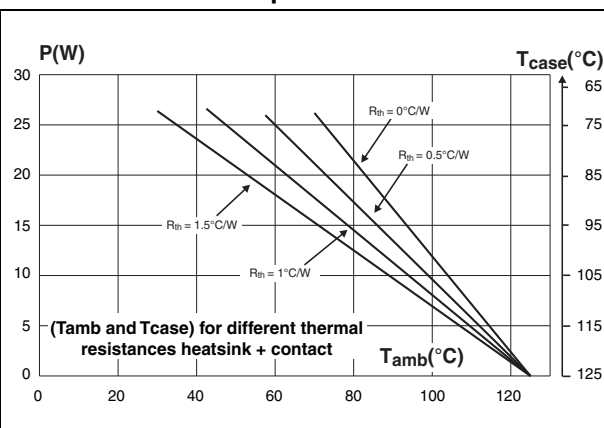

Figure 3. On-state rms current versus case temperature (full cycle)

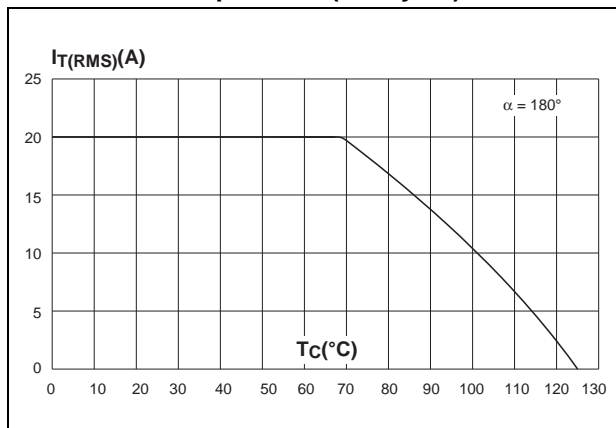

Figure 4. Relative variation of thermal impedance versus pulse duration

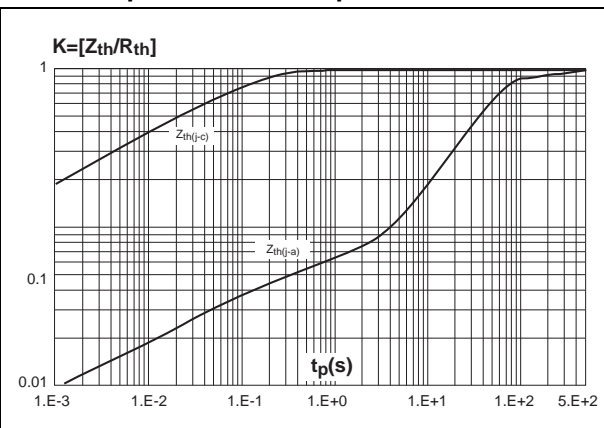

Figure 5. On-state characteristics (maximum values)

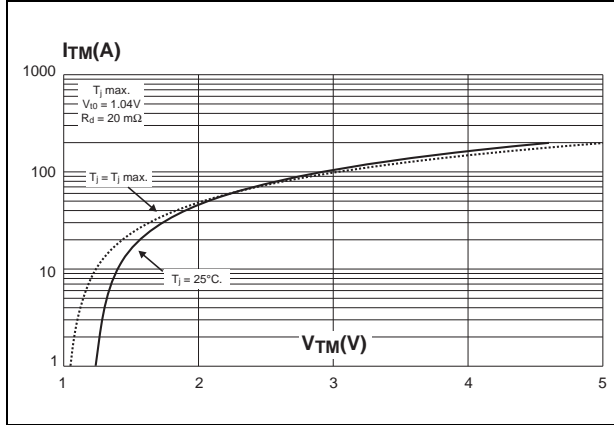

Figure 6. Non repetitive surge peak on-state current versus number of cycles

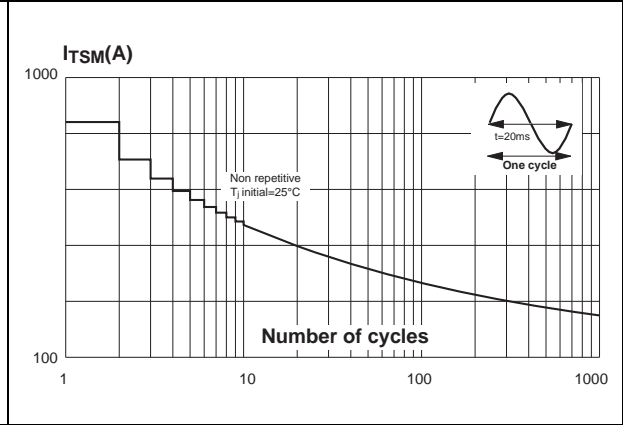

Figure 7. Non repetitive surge peak on-state current for a sinusoidal pulse and corresponding value of  $I^2t$

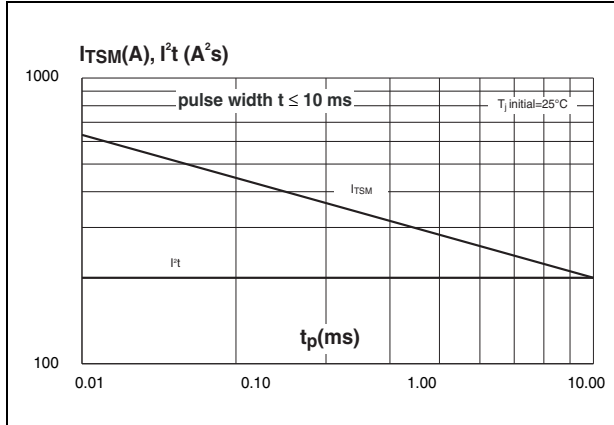
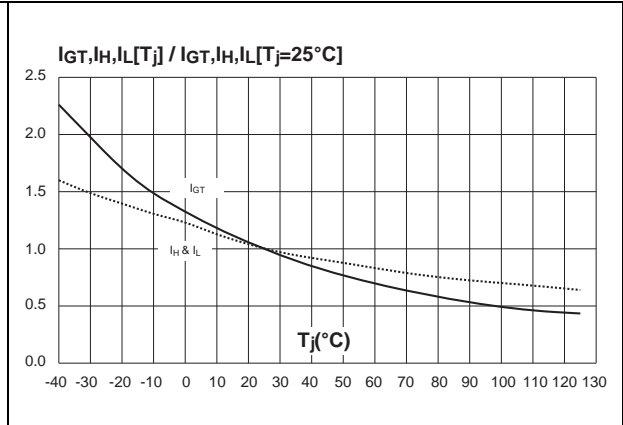

Figure 8. Relative variation of gate trigger current and holding current versus junction temperature



## 2 Package information

- Epoxy meets UL94, V0
- Lead-free package

In order to meet environmental requirements, ST offers these devices in different grades of ECOPACK<sup>®</sup> packages, depending on their level of environmental compliance. ECOPACK<sup>®</sup> specifications, grade definitions and product status are available at: [www.st.com](http://www.st.com). ECOPACK<sup>®</sup> is an ST trademark.

Figure 9. TO-220AB package dimensions (definitions)

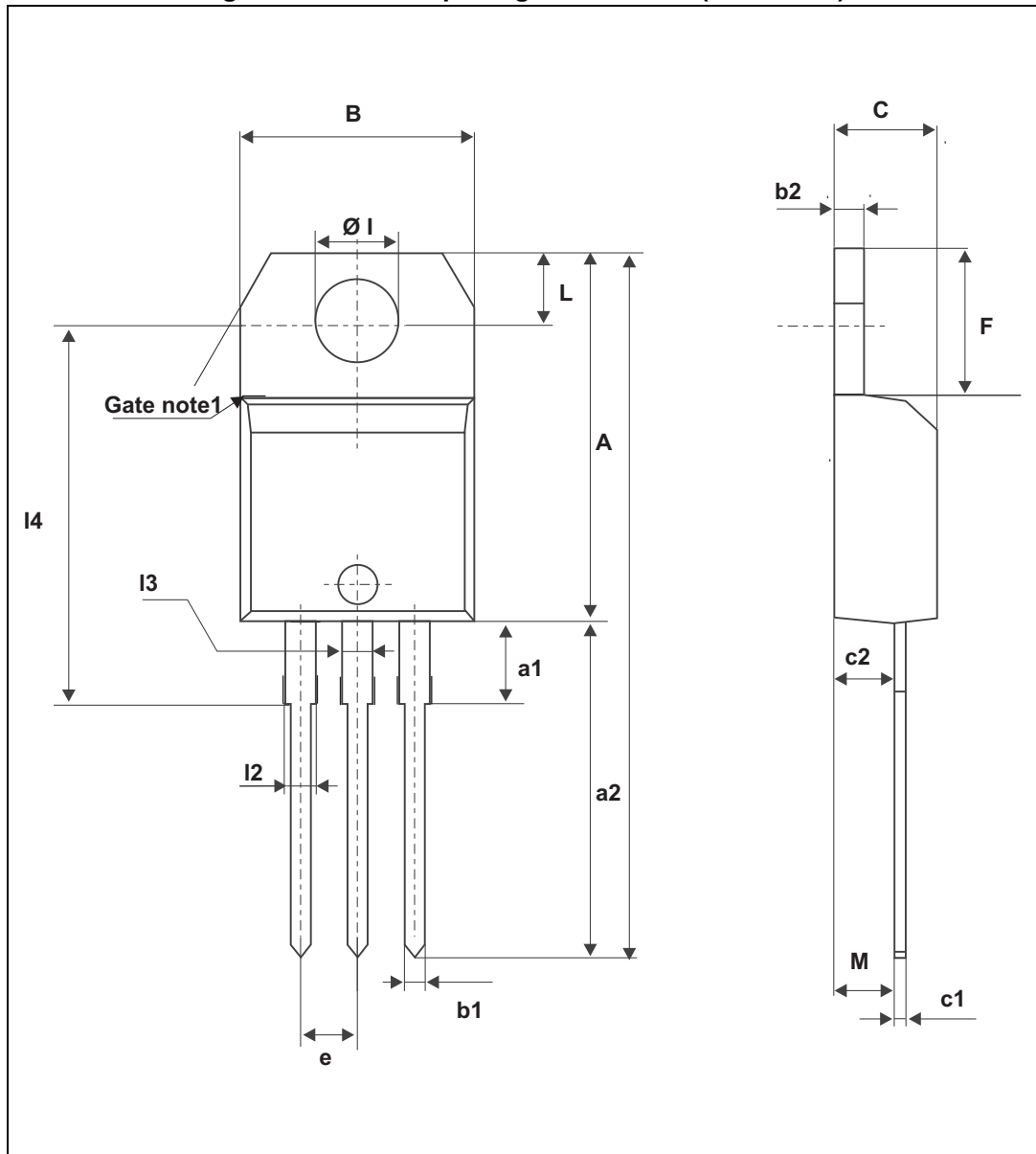

Table 5. TO-220AB package dimension values

Ref.	Dimensions					
	Millimeters			Inches		
	Min.	Typ.	Max.	Min.	Typ.	Max.
A	15.20		15.90	0.598		0.625
a1		3.75			0.147	
a2	13.00		14.00	0.511		0.551
B	10.00		10.40	0.393		0.409
b1	0.61		0.88	0.024		0.034
b2	1.23		1.32	0.048		0.051
C	4.40		4.60	0.173		0.181
c1	0.49		0.70	0.019		0.027
c2	2.40		2.72	0.094		0.107
e	2.40		2.70	0.094		0.106
F	6.20		6.60	0.244		0.259
I	3.75		3.85	0.147		0.151
I4	15.80	16.40	16.80	0.622	0.646	0.661
L	2.65		2.95	0.104		0.116
I2	1.14		1.70	0.044		0.066
I3	1.14		1.70	0.044		0.066
M		2.60			0.102	

### 3 Ordering information

Figure 10. Ordering information scheme

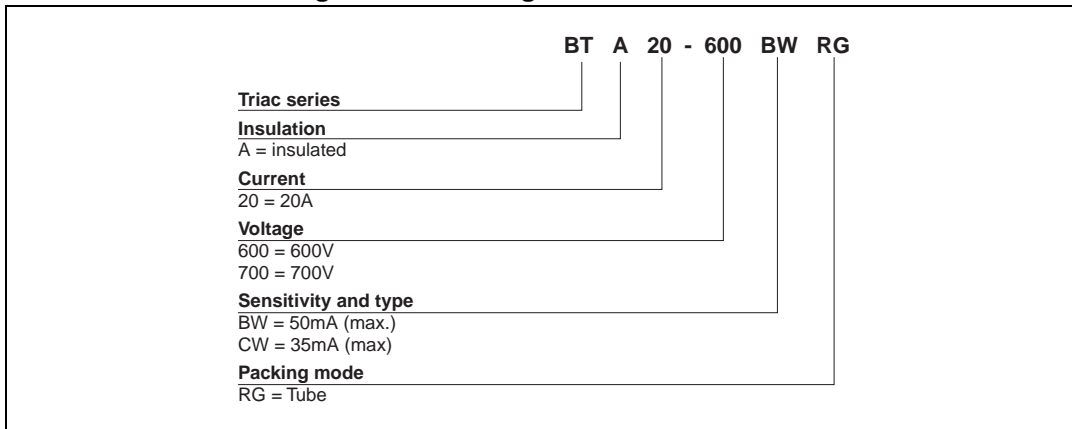

Table 6. Product selector

Order code	Voltage		Sensitivity	Type	Package
	600 V	700 V			
BTA20-600CWRG	X		35 mA	Snubberless	TO-220AB Ins.
BTA20-700BWRG		X	50 mA		
BTA20-700CWRG		X	35 mA		

Table 7. Ordering information

Ordering type	Marking	Package	Weight	Base qty	Delivery mode
BTA20-600CWRG	BTA20-600CW	TO-220AB Ins.	2.3 g	50	Tube
BTA20-700BWRG	BTA20-700BW				
BTA20-700CWRG	BTA20-700CW				

### 4 Revision history

Table 8. Document revision history

Date	Revision	Changes
Sep-2001	1A	Initial release.
08-Feb-2006	2	TO-220AB Ins. delivery mode changed from bulk to tube.
09-Jul-2012	3	Updated di/dt repetitive value in <a href="#">Table 1</a> .
01-Sep-2014	4	Updated V <sub>DRM</sub> /V <sub>RPM</sub> value in <a href="#">Table 1</a> .

**IMPORTANT NOTICE – PLEASE READ CAREFULLY**

STMicroelectronics NV and its subsidiaries ("ST") reserve the right to make changes, corrections, enhancements, modifications, and improvements to ST products and/or to this document at any time without notice. Purchasers should obtain the latest relevant information on ST products before placing orders. ST products are sold pursuant to ST's terms and conditions of sale in place at the time of order acknowledgement.

Purchasers are solely responsible for the choice, selection, and use of ST products and ST assumes no liability for application assistance or the design of Purchasers' products.

No license, express or implied, to any intellectual property right is granted by ST herein.

Resale of ST products with provisions different from the information set forth herein shall void any warranty granted by ST for such product.

ST and the ST logo are trademarks of ST. All other product or service names are the property of their respective owners.

Information in this document supersedes and replaces information previously supplied in any prior versions of this document.

© 2014 STMicroelectronics – All rights reserved