

# SMC

## 1.27 mm Connectors

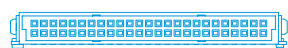

Full-scale SMC 50 Pins

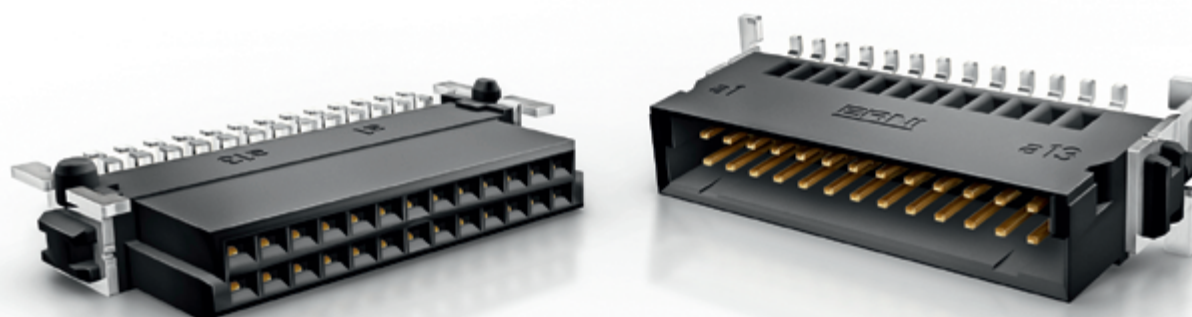

# SMC - 1.27 mm Connectors

## DUAL ROW CONNECTOR

### GENERAL

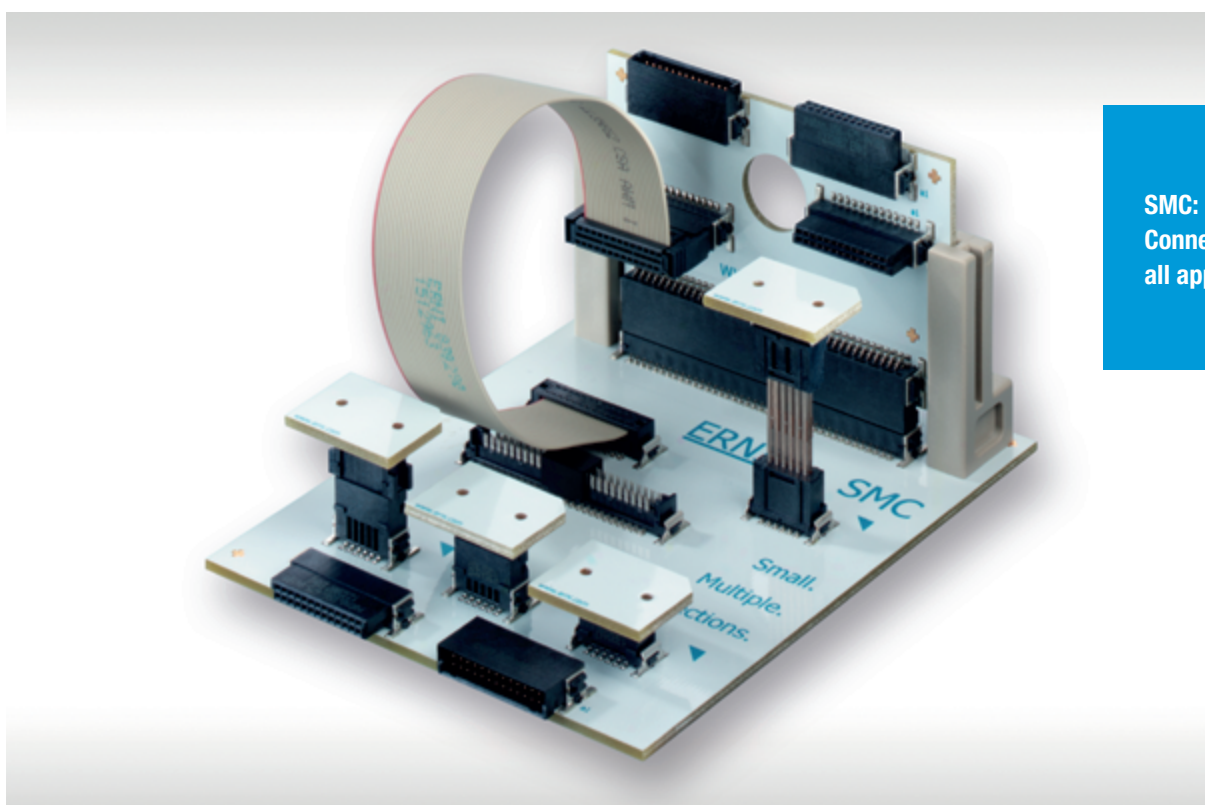

**SMC:**  
Connectors for  
all applications

### Small Grid, Big Possibilities

Limited space and high performance demands are characteristics of many modern electronic systems, all of which the connectors must accommodate. There is a corresponding demand for compact, secure, and reliable connectors, with high signal integrity and a relatively high current-carrying capacity.

The comprehensive SMC range helps meet these requirements. The high-performance SMT connectors come in a number of different designs, heights, and contact densities in a 1.27 mm grid.

The basic design criteria for the SMC series include double-sided spring contacts for top-rate contact properties and maximum contact reliability, a

high-temperature resistant insulator with polarization and insertion chamfers, and a very high mating reliability.

The perfect contact design exhibits a virtually continuous impedance profile and enables secure data transmission rates of up to 3 Gbit/s (differential) if the system is suitably designed.

# SMC - 1.27 mm Connectors

## CONCEPT —

### FEATURES

<b>Pitch</b>	1.27 mm
<b>No. of Pins</b>	12, 16, 20, 26, 32, 40, 50, 68, 80
<b>Termination technology</b>	SMT, individual variants in Pressfit technology
<b>Applications</b>	<p>Data rate up to 3 Gbit/s            Current rating up to 1.7 A per contact            Board-to-board connections:</p> <ul style="list-style-type: none"> <li>- stacked (Mezzanine)</li> <li>- orthogonal</li> <li>- coplanar</li> </ul> <p>Wire-to-Board connections (ribbon cable):</p> <ul style="list-style-type: none"> <li>- pluggable</li> <li>- permanent</li> </ul>
<b>Connectors</b>	<p>Male connectors, vertical and right angle            Female connectors, vertical and right angle            Board-to-Board adapter            Board-on IDC            Cable assembly:</p> <ul style="list-style-type: none"> <li>- Female connectors IDC, right angle</li> </ul>
<b>Special versions</b>	<p>Lockable connectors            Pressfit male connectors            Reduced locating pegs / without pegs            First mate/early break contacts</p>

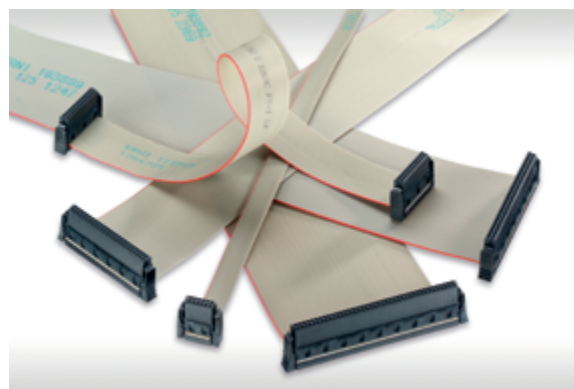
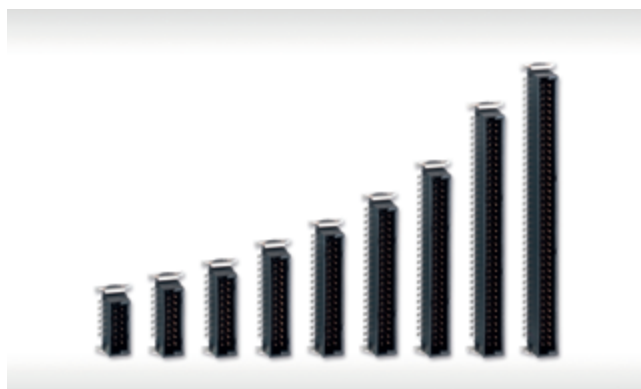

# SMC - 1.27 mm Connectors

## CONCEPT —

### CAPABILITIES

Stacked boards  
(Mezzanine)

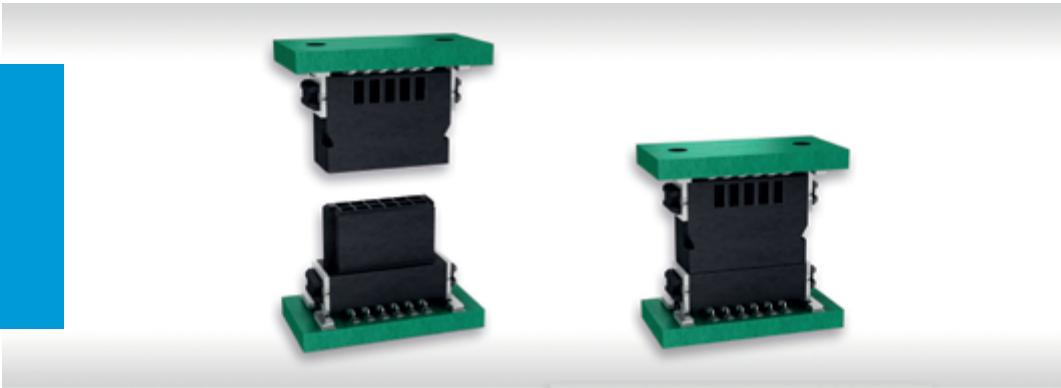

Board-to-board  
adapter: enhanced  
board-to-board  
heights

Extender card  
(coplanar)

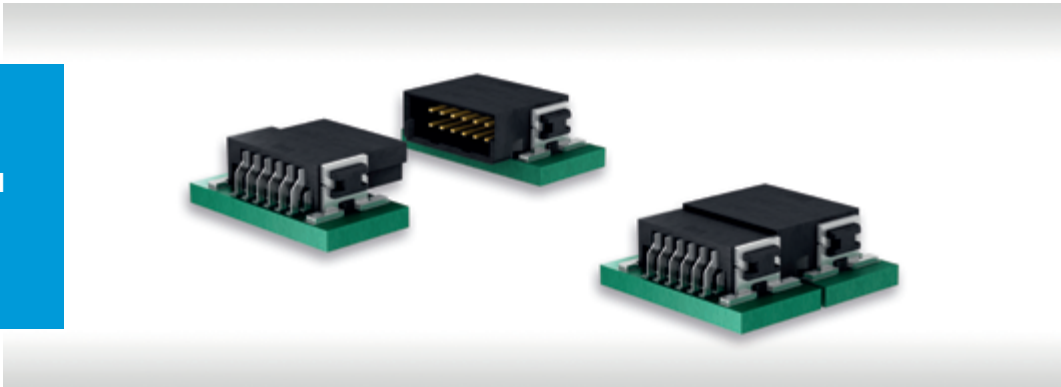

# SMC - 1.27 mm Connectors

## CONCEPT —

### CAPABILITIES

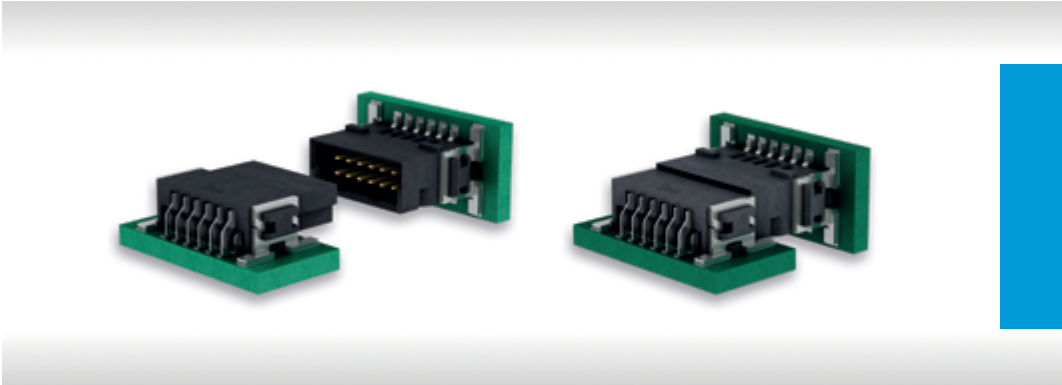

Orthogonal boards

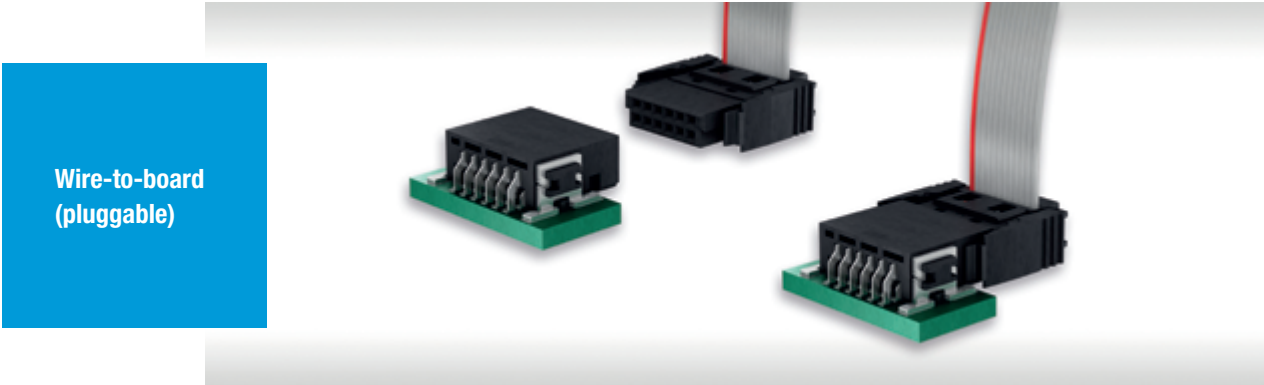

Wire-to-board (pluggable)

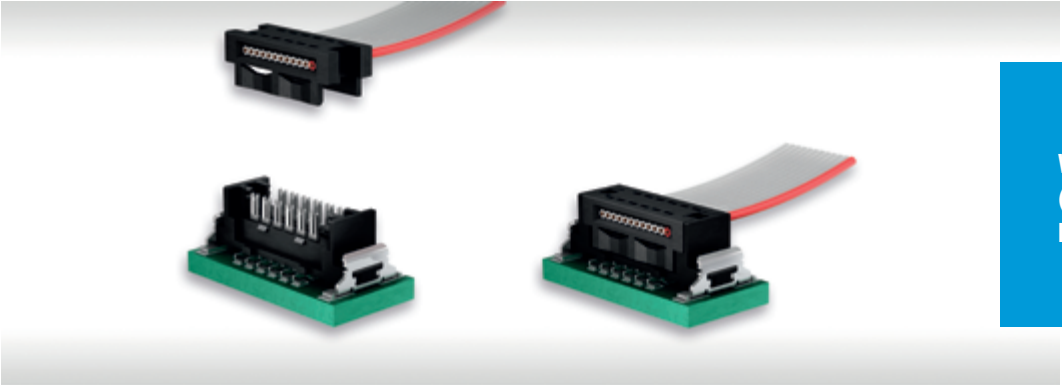

Wire-to-board (permanent):  
Board-on IDC

# SMC - 1.27 mm Connectors

## ADVANTAGES —

### ■ HIGH RELIABLE CONTACT DESIGN



- ultra-reliable, dual-beam female contact
- twisted contact tulip (90°)
- rolled, homogeneous surface, guarantees secure contact mating
- wide contact surfaces between the mated pairs
- extremely low surface roughness minimizes abrasion
- low contact resistance

### ■ POLARIZATION / MATING FACE

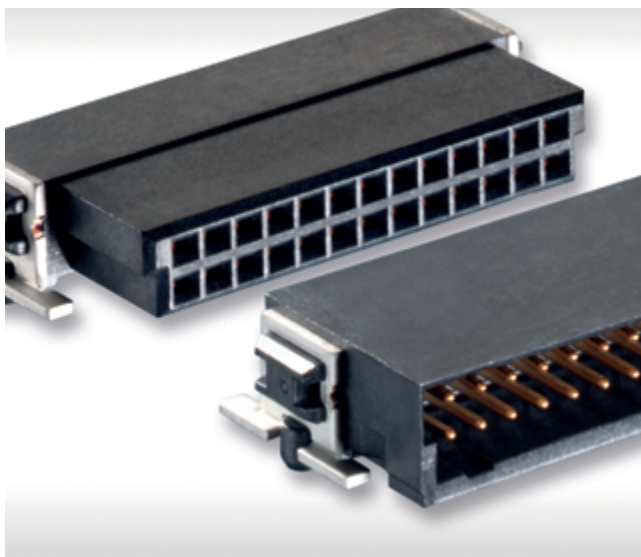

- mating face polarization prevents mismating and incorrect connection
- insertion chamfers in the capture range ensure secure mating
- distinctive guide elements for precise insertion

# SMC - 1.27 mm Connectors

## ADVANTAGES

### ROBUST SOLDER CLIPS

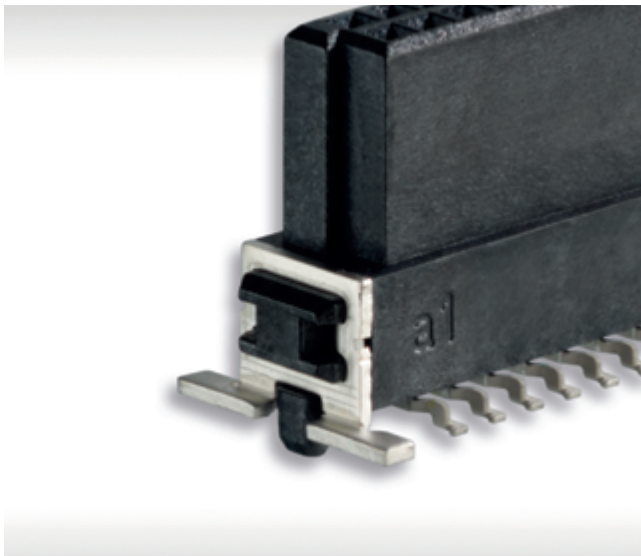

- outstanding retention forces on the circuit board
- soldering brackets absorb mechanical stress and are able to withstand high shock and vibration loads
- documented shear and tear-off forces build trust in surface-mounted connectors (e.g., shear force: min. 1000 N; tear-off force: min. 100 N)

### INTERLOCKING SNAP-IN

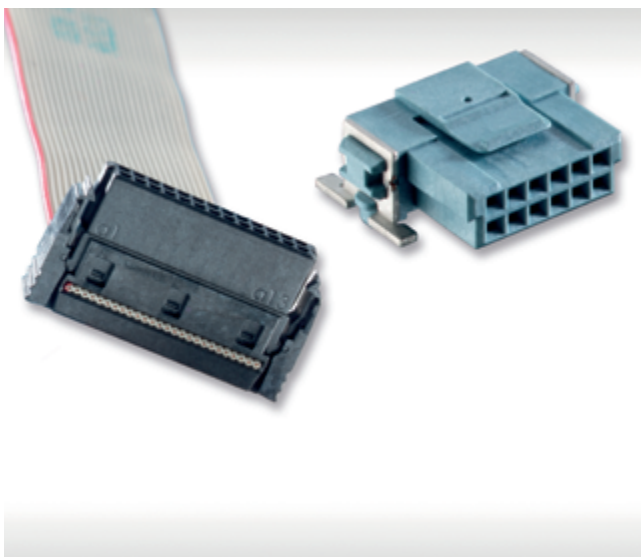

- lockable PCB and cable connectors
- secured against heavy vibration and shock loads
- snap-in: locking when mating; can only be released with tools
- cable connector: integrated locking lever; can be manually released without tools
- protection against accidental release of wire-to-board connections
- cable guide ensures strain relief

# SMC - 1.27 mm Connectors

## ADVANTAGES —

### ■ SNAP-IN B-TO-B ADAPTER

---



- single-sided locking of board-to-board adapters on low-profile female connectors
- enables the mating and release of two boards always on one specified side

### ■ LOCATING PEGS

---

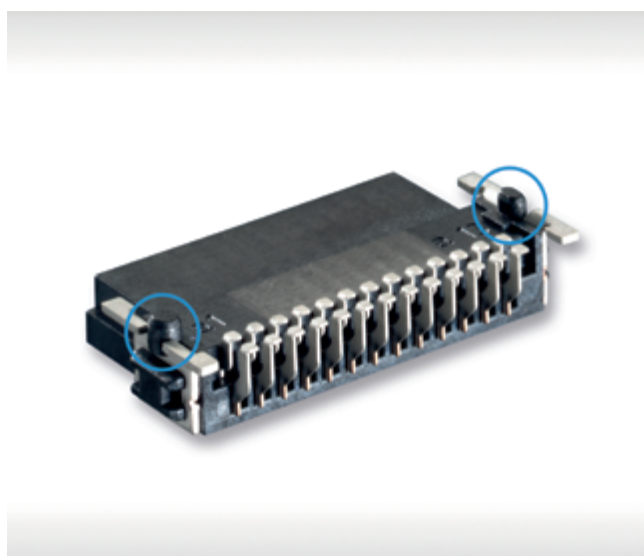

- geometrically heterogeneous locating pegs for precise positioning on the circuit board
- enables best possible compensation of PCB holes for both positive and negative tolerances



# SMC - 1.27 mm Connectors

## PROCESSING —

### TAPE AND REEL PACKAGING

---



transport safe packaging  
and fully automatic assembly

### FULLY AUTOMATIC ASSEMBLY AND REFLOW SOLDERING

---



for efficient processing on  
modern assembly lines

# SMC - 1.27 mm Connectors

## PROCESSING —



### BACKSIDE REFLOW SOLDERING

---

capable of two sided reflow soldering

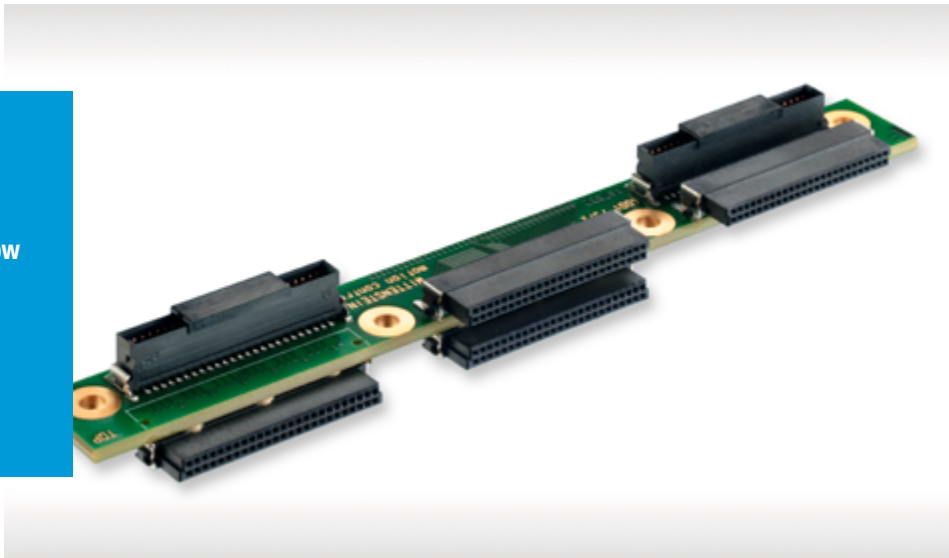

### PERMANENT WIRE-TO-BOARD CONNECTION (BOARD-ON IDC)

---

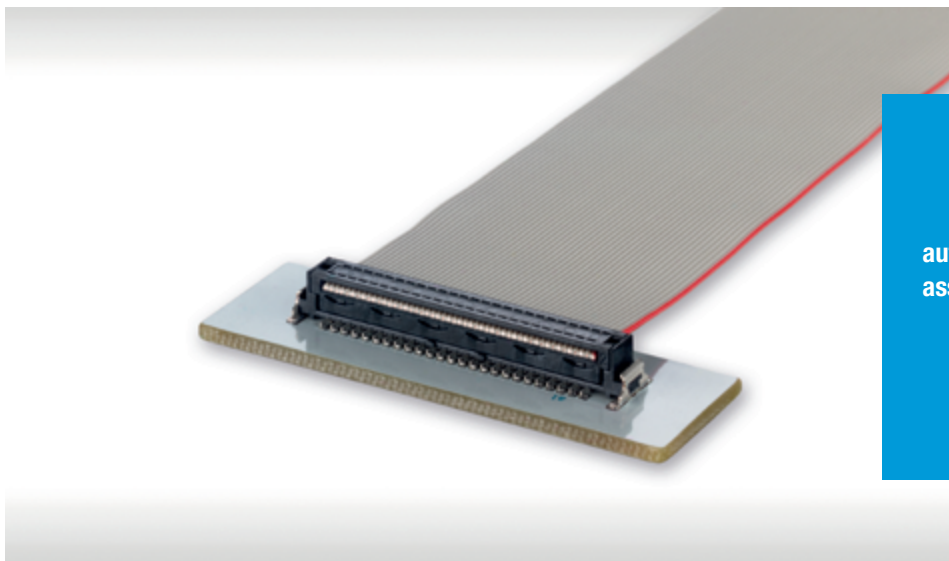

automated and cost-efficient assembly of ribbon cables

# SMC - 1.27 mm Connectors

## BOARD-ON IDC —

### PERMANENT WIRE-TO-BOARD CONNECTION

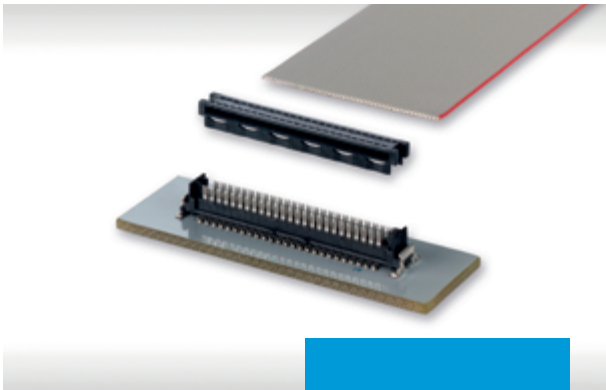

fully automated assembly

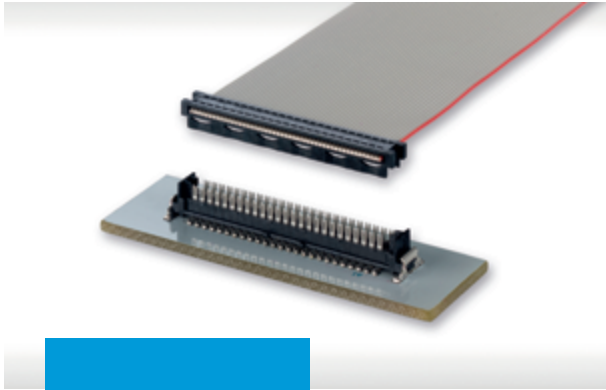

feeding of the ribbon cable and cable guide

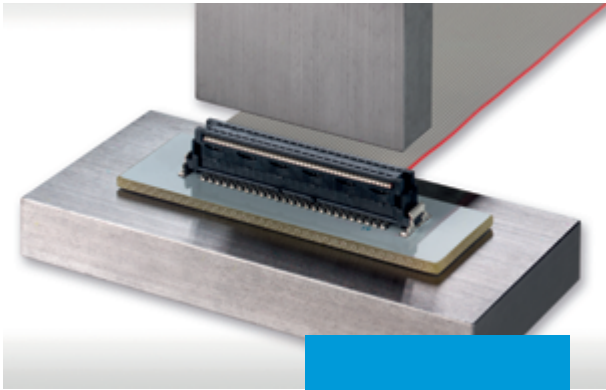

press-in without special tool

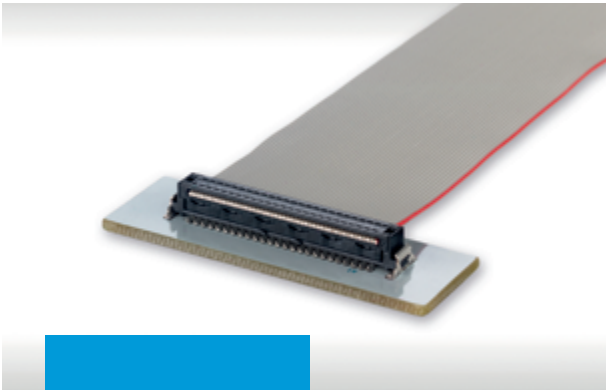

processed connection

# SMC - 1.27 mm Connectors

## MATING CONDITIONS

### ALLOWED INCLINATION FOR A SECURE SELF-CENTERING

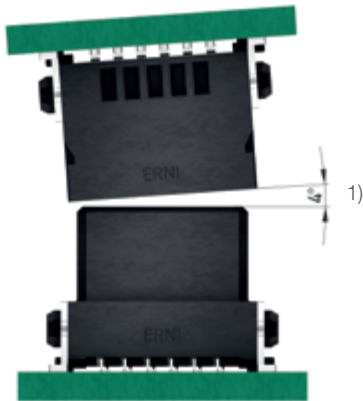

1) depends on No. of Pins and misalignment tolerance

### ALLOWED MISALIGNMENT TOLERANCES FOR A SECURE SELF-CENTERING

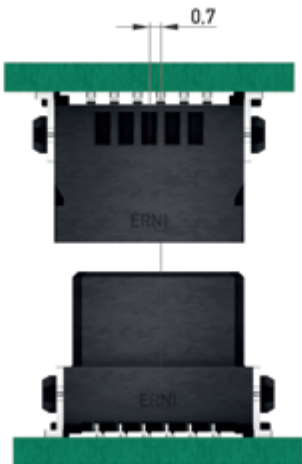

# SMC - 1.27 mm Connectors

## BOARD-TO-BOARD HEIGHT

### STACKED BOARDS / MEZZANINE

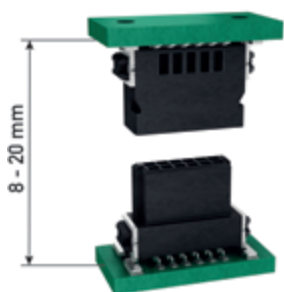

Board-to-Board Height	Male Stacking Height	Female Stacking Height
8.00 - 9.50 mm	1.75	6.25
9.50 - 11.0 mm	3.25	6.25
10.80 - 12.30 mm	1.75	9.05
12.30 - 13.80 mm	3.25	9.05
13.90 - 15.40 mm	4.85	9.05
15.40 - 16.90 mm	1.75	13.65
16.90 - 18.40 mm	3.25	13.65
18.50 - 20.00 mm	4.85	13.65

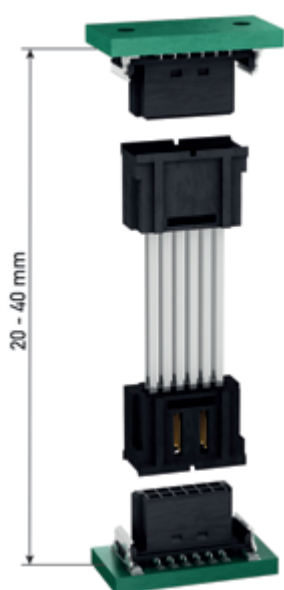

Board-to-Board Height	Board-to-Board Adapter	Female Stacking Height
20 mm	20	2 x 6.25
22 mm	22	2 x 6.25
24 mm	24	2 x 6.25
26 mm	26	2 x 6.25
28 mm	28	2 x 6.25
30 mm	30	2 x 6.25
32 mm	32	2 x 6.25
34 mm	34	2 x 6.25
36 mm	36	2 x 6.25
38 mm	38	2 x 6.25
40 mm	38 (reduced wipe length)	2 x 6.25

# SMC - 1.27 mm Connectors

## CHARACTERISTICS

### TECHNICAL DATA

Description	Standard	PCB Connectors, Cable Assemblies, B-to-B Adapter	Board-on IDC (Ribbon Cable AWG 30, 250 mm)
Climate category	DIN EN 60068-1 test b	55 / 150 / 56	55 / 125 / 56
Temperature range		-55 / 125 °C (PCB Connectors) -55 / 125 °C (TPE-S Cable)	-55 / 125 °C (TPE-S Cable)
Current rating per contact	IEC60512 test 5b	12-pin version at 20 °C ambient temperature: 1.7 A (up to 2.7 A with optimized layout)	
Air- and creepage distance		contact - contact min. 0.4 mm	
Operating voltage	IEC 60664	<p>The permissible operating voltages depend on the customer application and on the applicable or specified safety requirements. Insulation coordination according to IEC 60664-1 has to be regarded for the complete electrical device. Therefore, the maximum creepage and clearance distances of the mated connectors are specified for consideration as a part of the whole current path. In practice, reductions in creepage or clearance distances may occur due to the conductive pattern of the printed board or the wiring used, and have to be taken into account separately. As a result the creepage and clearance distances for the application may be reduced compared to those of the connector.</p>	
Dielectric strength	IEC 60512 test 4a	contact - contact 500 V <sub>rms</sub>	
Contact resistance	IEC 60512 test 2a	< 25 mΩ < 10 mΩ (cable assemblies)	< 10 mΩ
Insulation resistance	IEC 60512 test 3a	> 10 <sup>4</sup> MΩ	
Vibration, sine	IEC 60512 test 6d	10 – 2000 Hz 20 g	
Contact disturbance (while vibration test)	IEC 60512 test 2e	< 1 μs	
Shock halfsine	IEC 60512 test 6c	50 g 11 ms	
Contact disturbance (while shock test)	IEC 60512 test 2e	< 1 μs	

# SMC - 1.27 mm Connectors

## CHARACTERISTICS —

Description	Standard	PCB Connectors, Cable Assemblies, B-to-B Adapter	Board-on IDC (Ribbon Cable AWG 30, 250 mm)
Mechanical operation	IEC 60512 test 9a		500 mating cycles
Insertion and withdrawal force max.	IEC 60512 test 13b		0.5 N per contact
Gauge retention force	IEC 60512 test 16e		> 0.1 N
<b>Processing Conditions</b>			
Hand soldering temperature max.	IEC 60068-2-20		3.5 s at 350 °C
Dip soldering temperature max.	IEC 60068-2-20		10 s at 260 °C
Reflow soldering temperature max.	JEDEC J-STD-020		20 - 40 s at 260 °C
Coplanarity			< 0.1 mm
<b>Housing Material</b>			
Insulation body			LCP
CTI value	IEC 112		175
UL flame rating			UL 94 V-0
UL file plastic material			E83005
<b>Contact Material</b>			
Base material			Cu alloy
Mating area		gold plating	—
Termination area			Sn
<b>Environment Compatibility</b>			
Recycling		no flame-retardent additives, no toxic additives allow easy recycling	
<b>Product Approval</b>			
UL/CSA			E84703

# SMC - 1.27 mm Connectors

## CABLE CHARACTERISTICS

### TECHNICAL DATA FLAT RIBBON CABLES

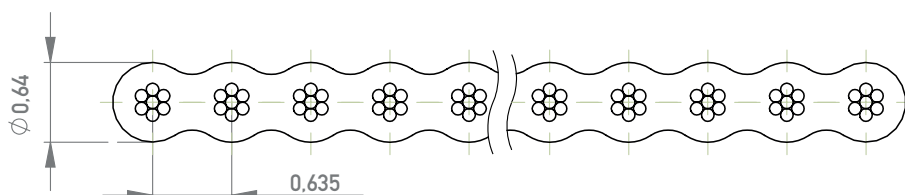

Description	Standard cable (PVC)	High Temperature Cable (TPE-S)	Halogen-free Cable (Polyolefin TPE-O)
Cross section	AWG-30/ 7/ 0.06 mm <sup>2</sup>		
Conductor	stranded Cu wire, tinned, 7x0.102 / 0.06 mm <sup>2</sup>		
Coded wire	available		
Insulation	PVC gray (similar to RAL 78032)	TPE-S gray (similar to RAL 78032)	TPE-O gray (similar to RAL 78032)
Insulation thickness	min. 0.1mm		
Shore hardness	94 ±2 (Shore A)	52 ±3 (Shore D)	94 ±2 (Shore A); 50 ±3 (Shore D)
<b>Technical Data</b>			
Temperature range	-20/105 °C (fixed) -10/105 °C (mobile)	-60/125 °C (fixed) -40/125 °C (mobile)	-40/105 °C (fixed) -20/105 °C (mobile)
Dielectric strength	1500 V <sub>rms</sub>	1000 V <sub>rms</sub>	1200 V <sub>rms</sub>
Conductor resistance	≤ 350 Ω/km at 20 °C		
Insulation resistance	≥ 20 MΩ x km at 20 °C		
Impedance	125 Ω (wire-wire) 80 Ω (Ground-Signal-Ground)	136 Ω (wire-wire)	110 Ω (wire-wire) 75 Ω (Ground-Signal-Ground)
Bending cycles (typical)	min. 1 million at 20 x cable diameter		
RoHS	compliant		
Flame rating	UL 94 VW-1	IEC 60332-1-2	UL 1581 (Horizontal Flame Test)



# SMC - 1.27 mm Connectors

## HIGH FREQUENCY CHARACTERISTICS

### HIGH-SPEED DATA TRANSMISSION

SMC connectors as solution for unshielded high-speed applications. The practically continuous impedance profile allows for secure data transmission rates of up to 3 Gbit/s (differential) if the system is suitably designed.

- De-embedded measurement results for the micro backplane/daughter card application
- 50-pin SMC, angled female connector, straight male connector (low profile)
- Differential signal transmission

### INSERTION LOSS

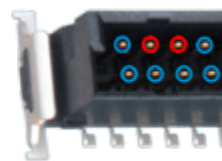
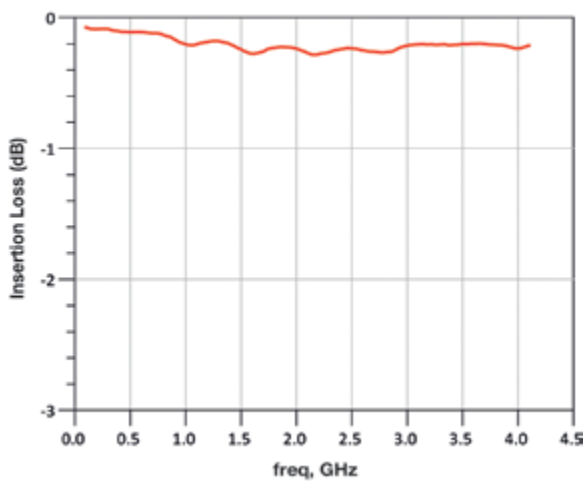

- Ground
- Signal

### NEAR END CROSSTALK (NEXT)

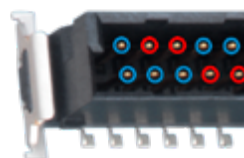
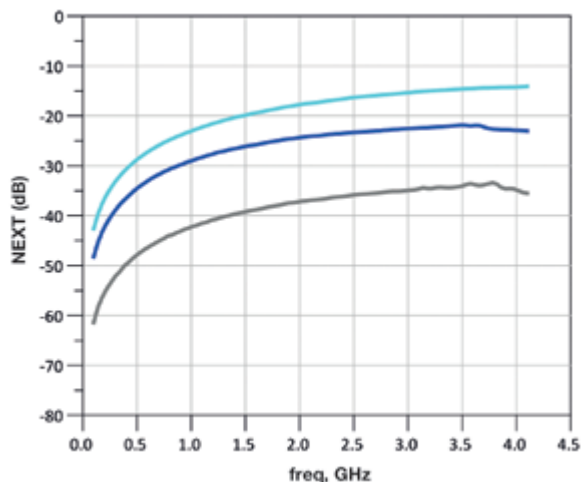

- Ground
- Signal

- Agressor / Victim
- A2\_3 / B2\_3
  - A2\_3 / A4\_5
  - A2\_3 / B4\_5 (shown above)

# SMC - 1.27 mm Connectors

## RIGHT ANGLE MALE

### PRODUCT SPECIFICATION



- SMT termination
- dual row connector
- data rates up to 3 Gbit/s
- location pegs for exact board placement
- black insulation body for fast and reliable visual recognition
- fully automated board assembly

### DIMENSIONAL DRAWINGS

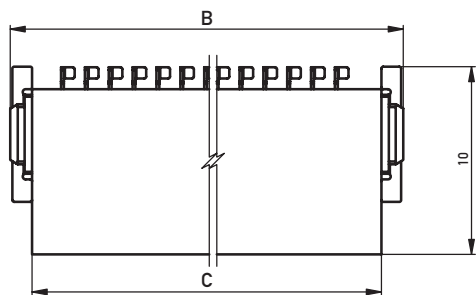
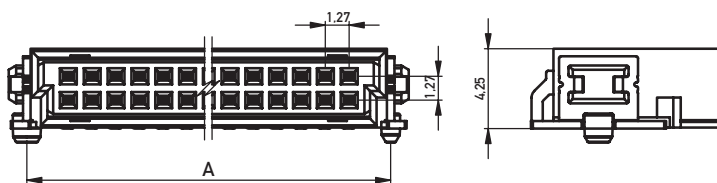

12	10.77	12.70	10.35
16	13.31	15.24	12.91
20	15.85	17.78	15.45
26	19.66	21.59	19.26
32	23.47	25.40	23.07
40	28.55	30.48	28.15
50	34.90	36.83	34.50
68	46.33	48.26	45.93
80	53.95	55.88	53.55
No. of contacts	A	B	C

#### Recommended Layout

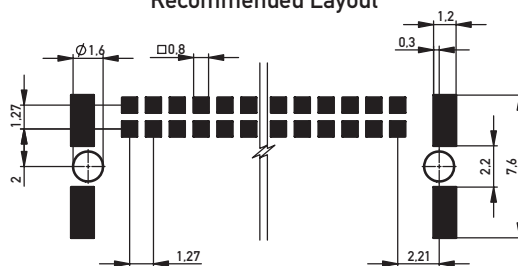

# SMC - 1.27 mm Connectors

## RIGHT ANGLE MALE —

### ORDERING INFORMATION

No. of Pins	Packaging	Part Number
12	Tape and reel	154763
16	Tape and reel	354094
20	Tape and reel	354095
26	Tape and reel	154764
32	Tape and reel	354096
40	Tape and reel	354097
50	Tape and reel	154765
68	Tape and reel	154766
80	Tape and reel	154767

# SMC - 1.27 mm Connectors

## RIGHT ANGLE FEMALE

### PRODUCT SPECIFICATION



- SMT termination
- dual row connector
- data rates up to 3 Gbit/s
- location pegs for exact board placement
- black insulation body for fast and reliable visual recognition
- fully automated board assembly

### DIMENSIONAL DRAWINGS

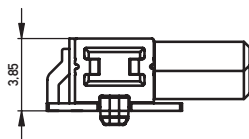
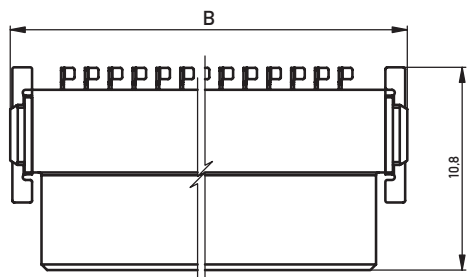
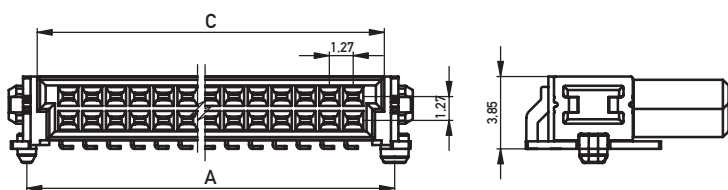

Recommended Layout

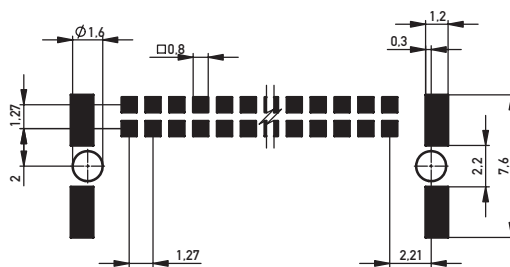

12	10.77	12.70	9.37
16	13.31	15.24	11.91
20	15.85	17.78	14.45
26	19.66	21.59	18.26
32	23.47	25.40	22.07
40	28.55	30.48	27.15
50	34.90	36.83	33.50
68	46.33	48.26	44.93
80	53.95	55.88	52.55
No. of contacts	A	B	C

# SMC - 1.27 mm Connectors

## RIGHT ANGLE FEMALE

### ORDERING INFORMATION

No. of Pins	Packaging	Part Number
12	Tape and reel	154740
16	Tape and reel	354078
20	Tape and reel	354079
26	Tape and reel	154741
32	Tape and reel	354080
40	Tape and reel	354081
50	Tape and reel	154742
68	Tape and reel	154743
80	Tape and reel	154744

# SMC - 1.27 mm Connectors

## VERTICAL MALE

### PRODUCT SPECIFICATION

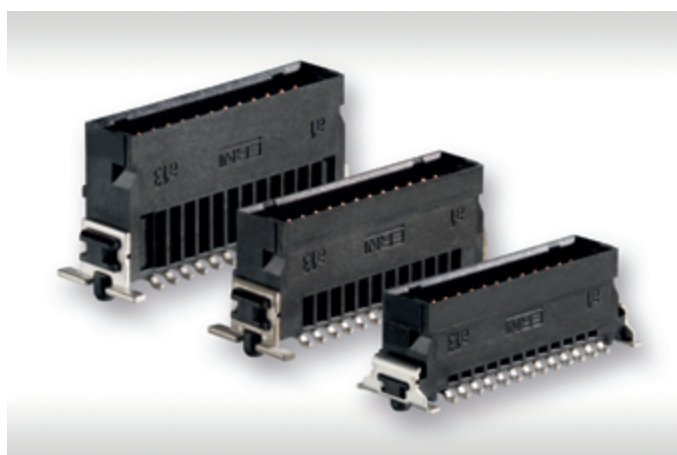

- SMT termination
- dual row connector
- data rate up to 3 Gbit/s
- location pegs for exact board placement
- black insulation body for fast and reliable visual recognition
- fully automated board assembly
- 3 stacking heights (1.75, 3.25, 4.85 mm)

### DIMENSIONAL DRAWINGS

#### Unmated Stacking Height 3.25 mm

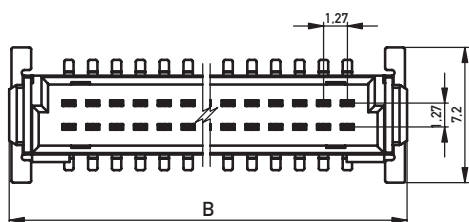
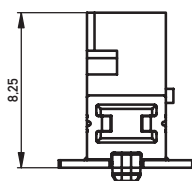
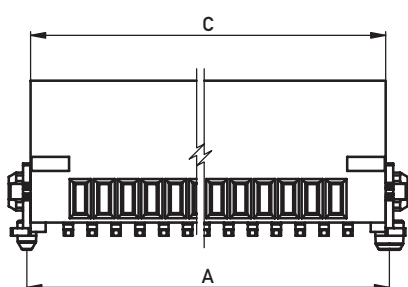

12	10.77	12.70	10.37
16	13.31	15.24	12.91
20	15.85	17.78	15.45
26	19.66	21.59	19.26
32	23.47	25.40	23.07
40	28.55	30.48	28.15
50	34.90	36.83	34.50
68	46.33	48.26	45.93
80	53.95	55.88	53.55
No. of contacts	A	B	C

#### Recommended Layout

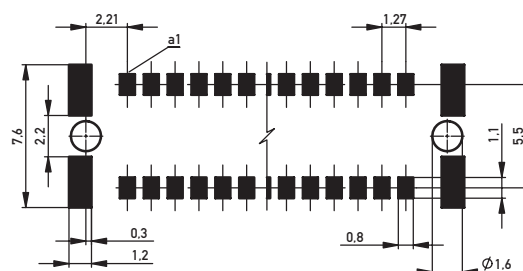

# SMC - 1.27 mm Connectors

## VERTICAL MALE

### ORDERING INFORMATION

No. of Pins	Unmated Stacking Height	Packaging	Part Number
12	1.75	Tape and reel	244836
16	1.75	Tape and reel	254587
20	1.75	Tape and reel	254588
26	1.75	Tape and reel	244837
32	1.75	Tape and reel	254589
40	1.75	Tape and reel	254590
50	1.75	Tape and reel	244838
68	1.75	Tape and reel	244839
80	1.75	Tape and reel	244840
12	3.25	Tape and reel	244854
16	3.25	Tape and reel	254536
20	3.25	Tape and reel	254537
26	3.25	Tape and reel	244855
32	3.25	Tape and reel	254538
40	3.25	Tape and reel	254539
50	3.25	Tape and reel	244856
68	3.25	Tape and reel	244857
80	3.25	Tape and reel	244858

# SMC - 1.27 mm Connectors

## VERTICAL MALE —

No. of Pins	Unmated Stacking Height	Packaging	Part Number
12	4.85	Tape and reel	234206
16	4.85	Tape and reel	254414
20	4.85	Tape and reel	254415
26	4.85	Tape and reel	234207
32	4.85	Tape and reel	254416
40	4.85	Tape and reel	254417
50	4.85	Tape and reel	234208
68	4.85	Tape and reel	234209
80	4.85	Tape and reel	234210



# SMC - 1.27 mm Connectors

## VERTICAL MALE PRESSFIT

### PRODUCT SPECIFICATION

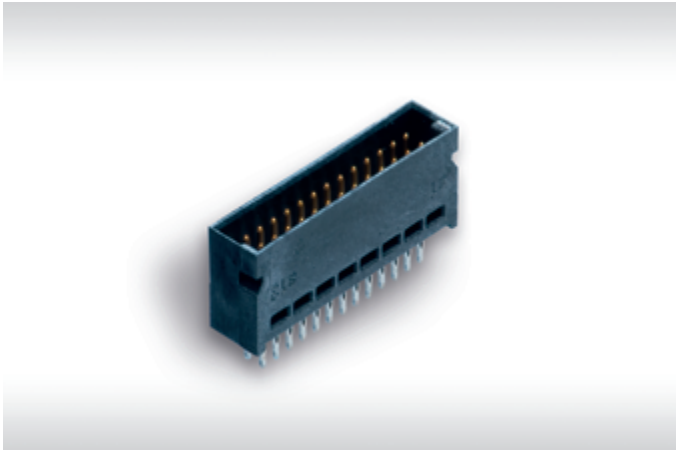

- pressfit termination
- dual row connector
- data rates up to 3 Gbit/s
- black insulation body for fast and reliable visual recognition
- fully automated board assembly
- stacking height 3.25 mm

### DIMENSIONAL DRAWINGS

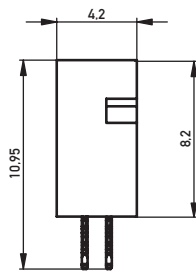
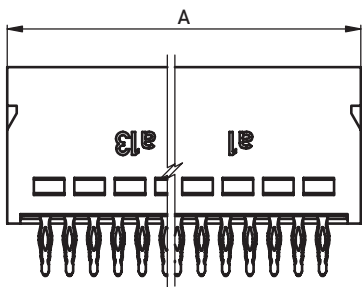

Recommended Layout

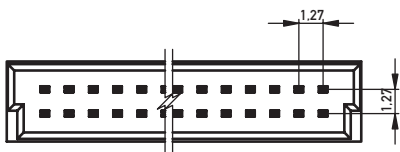
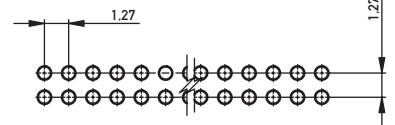

12	10.35
26	19.24
50	34.48
68	45.91
80	53.53
No. of contacts	A

Hole Design

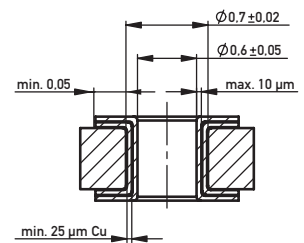

# SMC - 1.27 mm Connectors

## VERTICAL MALE PRESSFIT

### ORDERING INFORMATION

No. of Pins	Unmated Stacking Height	Packaging	Part Number
12	3.25	Tube	064002
26	3.25	Tube	064003
50	3.25	Tube	064004
68	3.25	Tube	144183
80	3.25	Tube	144185

# SMC - 1.27 mm Connectors

## VERTICAL FEMALE

### PRODUCT SPECIFICATION

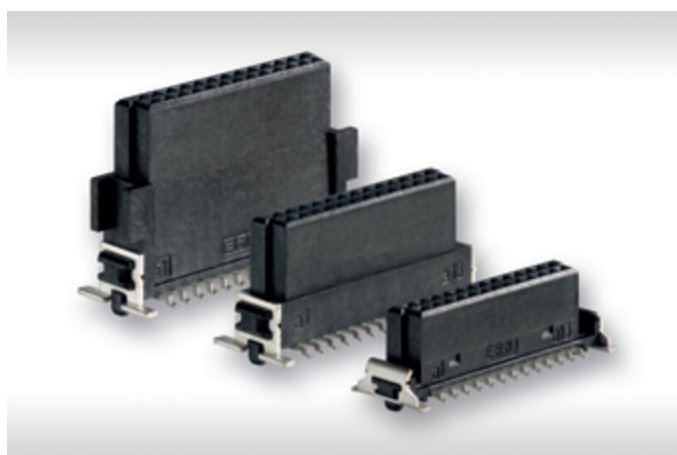

- SMT termination
- dual row connector
- data rates up to 3 Gbit/s
- location pegs for exact board placement
- black insulation body for fast and reliable visual recognition
- fully automated board assembly
- 3 stacking heights (6.25, 9.05, 13.65 mm)

### DIMENSIONAL DRAWINGS

Unmated Stacking Height 9.05 mm

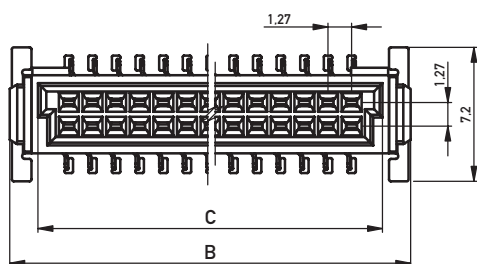
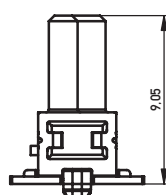
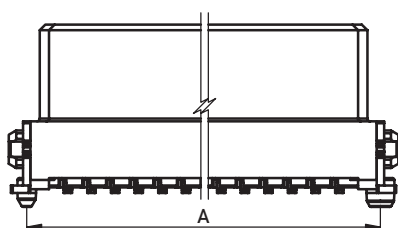

12	10.77	12.70	9.37
16	13.31	15.24	11.91
20	15.85	17.78	14.45
26	19.66	21.60	18.26
32	23.47	25.40	22.07
40	28.55	30.48	27.15
50	34.90	36.80	33.50
68	46.33	48.20	44.93
80	53.95	55.80	52.55
No. of contacts	A	B	C

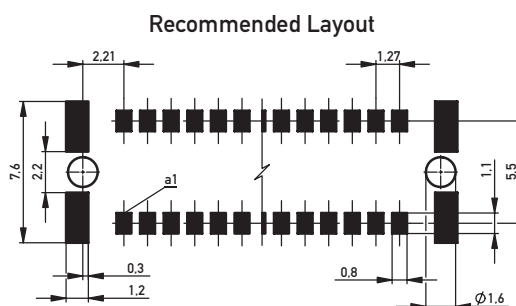

# SMC - 1.27 mm Connectors

## VERTICAL FEMALE

### ORDERING INFORMATION

No. of Pins	Unmated Stacking Height	Packaging	Part Number
12	6.25	Tape and reel	154805
16	6.25	Tape and reel	354055
20	6.25	Tape and reel	354056
26	6.25	Tape and reel	154806
32	6.25	Tape and reel	354057
40	6.25	Tape and reel	204632
50	6.25	Tape and reel	154807
68	6.25	Tape and reel	154808
80	6.25	Tape and reel	154809
12	9.05	Tape and reel	154717
16	9.05	Tape and reel	354062
20	9.05	Tape and reel	354063
26	9.05	Tape and reel	154718
32	9.05	Tape and reel	354064
40	9.05	Tape and reel	354065
50	9.05	Tape and reel	154719
68	9.05	Tape and reel	154720
80	9.05	Tape and reel	154721

# SMC - 1.27 mm Connectors

## VERTICAL FEMALE —

No. of Pins	Unmated Stacking Height	Packaging	Part Number
12	13.65	Tape and reel	234198
16	13.65	Tape and reel	354070
20	13.65	Tape and reel	354071
26	13.65	Tape and reel	204763
32	13.65	Tape and reel	354072
40	13.65	Tape and reel	354073
50	13.65	Tape and reel	234199
68	13.65	Tape and reel	234200
80	13.65	Tape and reel	234201

# SMC - 1.27 mm Connectors

## RIGHT ANGLE MALE WITH LOCKING SYSTEM

### PRODUCT SPECIFICATION

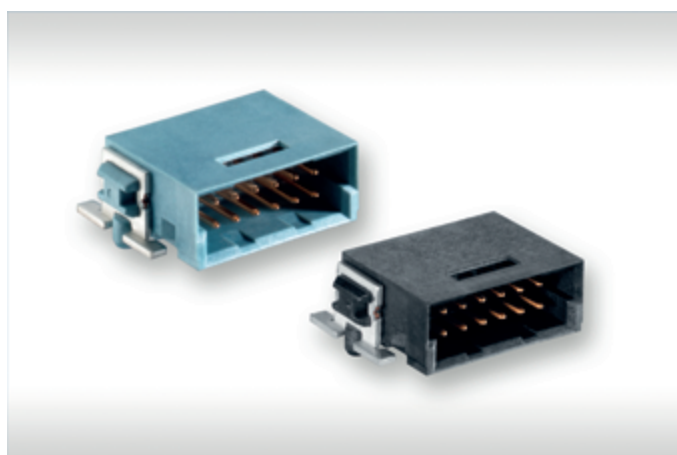

- two types of interlocking:
  - positive lock (blue colored): unlockable i.e. by tool, tip of pen
  - friction lock (black colored): unlockable without any tool
- SMT termination
- data rates up to 3 Gbit/s
- location pegs for exact board placement
- fully automated board assembly

### DIMENSIONAL DRAWINGS

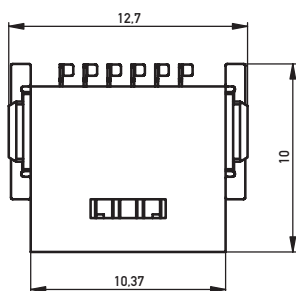
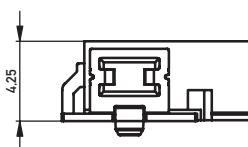
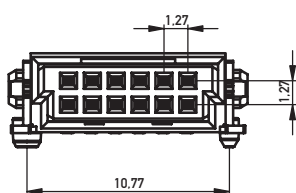

#### Recommended Layout

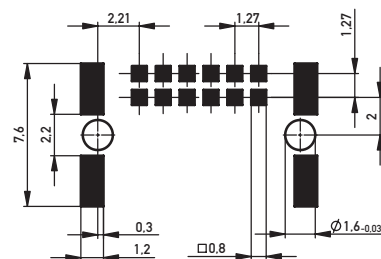

# SMC - 1.27 mm Connectors

## RIGHT ANGLE MALE WITH LOCKING SYSTEM

### ORDERING INFORMATION

No. of Pins	Interlocking	Color	Packaging	Part Number
12	unlockable with tool	blue	Tape and reel	254273
12	unlockable without tool	black	Tape and reel	354949

Description	Part Number
Unlocking tool	484816

# SMC - 1.27 mm Connectors

## RIGHT ANGLE FEMALE WITH LOCKING SYSTEM

### PRODUCT SPECIFICATION

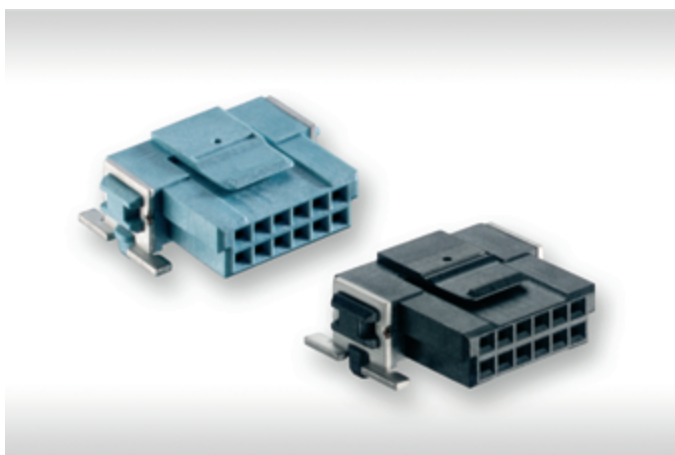

- two types of interlocking:
  - positive lock (blue colored): unlockable i.e. by tool, tip of pen
  - friction lock (black colored): unlockable without any tool
- SMT termination
- data rates up to 3 Gbit/s
- location pegs for exact board placement
- fully automated board assembly

### DIMENSIONAL DRAWINGS

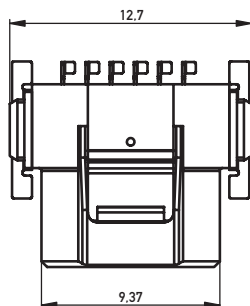
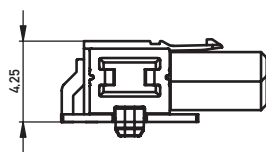
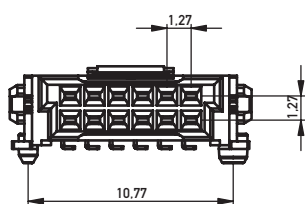

Recommended Layout

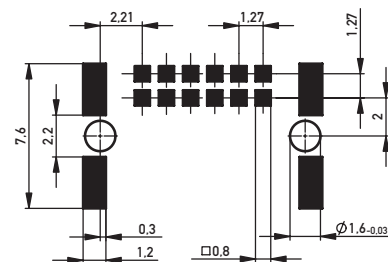



# SMC - 1.27 mm Connectors

## RIGHT ANGLE FEMALE WITH LOCKING SYSTEM



### ORDERING INFORMATION

No. of Pins	Interlocking	Color	Packaging	Part Number
12	unlockable with tool	blue	Tape and reel	254262
12	unlockable without tool	black	Tape and reel	354939

Description	Part Number
Unlocking tool	484816

# SMC - 1.27 mm Connectors

## BOARD-TO-BOARD ADAPTER

### PRODUCT SPECIFICATION



- Board-to-board Adapter for parallel PCB distances of 20-40 mm
- moulded (hotmelt) versions for improved environmental resistance and finger safe protection
- single-sided locking of board-to-board adapters on low-profile female connectors
- enables the mating and release of two boards always on one specified side

### DIMENSIONAL DRAWINGS

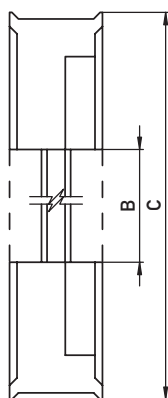
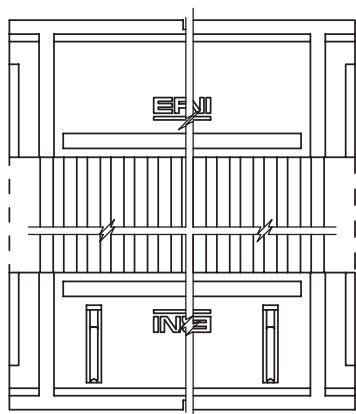
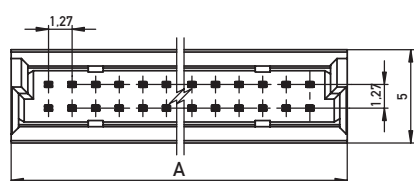

12	10.37
26	19.26
50	34.5
68	45.93
80	53.55
No. of contacts	A

20	3.5	18.2
22	5.5	20.2
24	7.5	22.2
26	9.5	24.2
28	11.5	26.2
30	13.5	28.2
32	15.5	30.2
34	17.5	32.2
36	19.5	34.2
38	21.5	36.2
B-to-B Adapter (Board Distance)	B	C

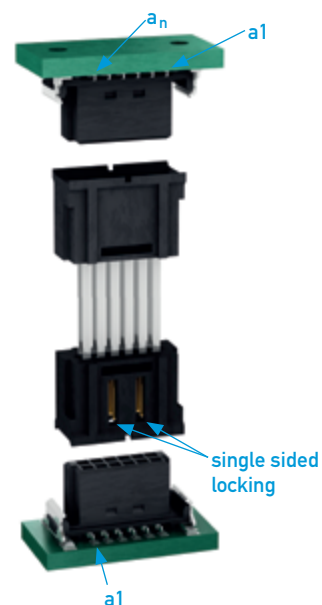

# SMC - 1.27 mm Connectors

## BOARD-TO-BOARD ADAPTER

### ORDERING INFORMATION

No. of Pins	Board Distance	Packaging	Part Number
12	20	Tray	364094
12	22	Tray	364095
12	24	Tray	364096
12	26	Tray	364097
12	28	Tray	364098
12	30	Tray	364099
12	32	Tray	364100
12	34	Tray	364101
12	36	Tray	364102
12	38	Tray	364103
26	20	Tray	364084
26	22	Tray	364085
26	24	Tray	364086
26	26	Tray	364087
26	28	Tray	364088
26	30	Tray	364089
26	32	Tray	364090
26	34	Tray	364091

Board-to-board distance 40 mm: Board-to-board Adapter 38 with reduced wipe length, on request

# SMC - 1.27 mm Connectors

## BOARD-TO-BOARD ADAPTER —

No. of Pins	Board Distance	Packaging	Part Number
26	36	Tray	364092
26	38	Tray	364093
50	20	Tray	354307
50	22	Tray	354308
50	24	Tray	354309
50	26	Tray	354310
50	28	Tray	354311
50	30	Tray	354312
50	32	Tray	354313
50	34	Tray	354314
50	36	Tray	354315
50	38	Tray	354316
68	20	Tray	364715
68	22	Tray	354029
68	24	Tray	364717
68	26	Tray	364718
68	28	Tray	364719
68	30	Tray	364720
68	32	Tray	364721
68	34	Tray	364722

Board-to-board distance 40 mm: Board-to-board Adapter 38 with reduced wipe length, on request

# SMC - 1.27 mm Connectors

## BOARD-TO-BOARD ADAPTER

No. of Pins	Board Distance	Packaging	Part Number
68	36	Tray	364723
68	38	Tray	364724
80	20	Tray	364725
80	22	Tray	364726
80	24	Tray	364727
80	26	Tray	364728
80	28	Tray	364729
80	30	Tray	364730
80	32	Tray	364731
80	34	Tray	364732
80	36	Tray	364733
80	38	Tray	354030

Board-to-board distance 40 mm: Board-to-board Adapter 38 with reduced wipe length, on request

### Moulded Versions

No. of Pins	Board Distance	Packaging	Part Number
26	24	Tray	474589
50	22	Tray	474588

# SMC - 1.27 mm Connectors

## BOARD-ON IDC

### PRODUCT SPECIFICATION



- permanent wire-to-board connection
- SMT and IDC termination
- dual row connector
- data rates up to 3 Gbit/s
- location pegs for exact board placement
- black insulation body for fast and reliable visual recognition
- flat ribbon cables AWG 30
- easy assembly with standard toggle press

### DIMENSIONAL DRAWINGS

#### Board-on Connectors

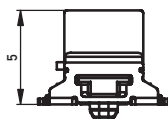
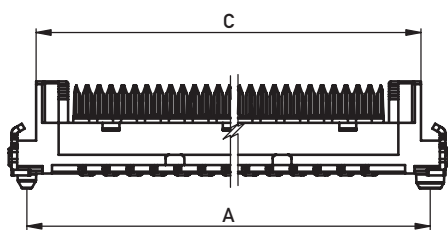

#### Recommended Layout

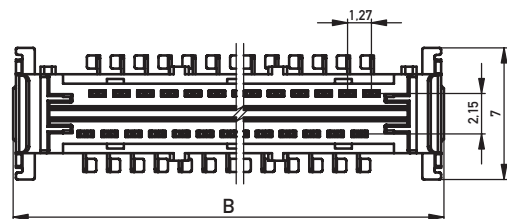
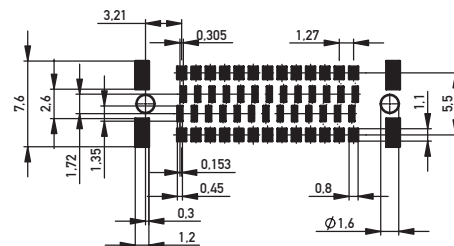

12	12.77	14.70	11.78
26	21.66	23.59	20.67
50	36.90	38.83	35.91
No. of contacts	A	B	C

# SMC - 1.27 mm Connectors

## BOARD-ON IDC

### Board-on Cable Guide

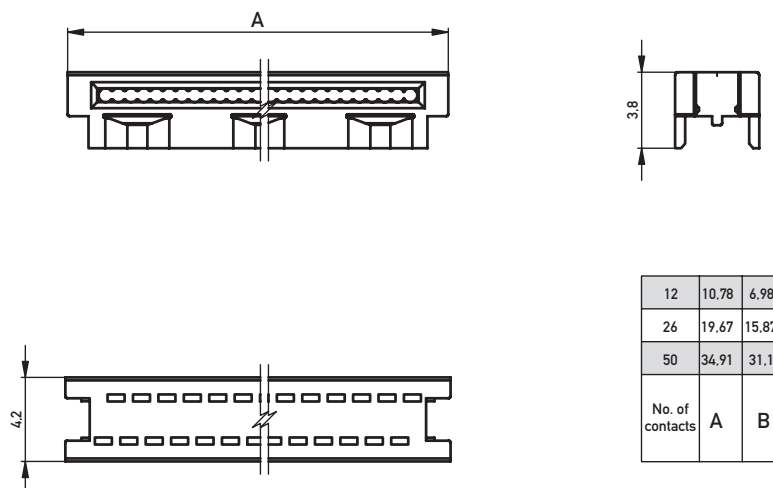

### ORDERING INFORMATION

No. of Pins	Configuration	Packaging	Part Number
12	Connector	Tape and reel	244628
12	Cable guide	Poly bag	244631
26	Connector	Tape and reel	244629
26	Cable guide	Poly bag	244632
50	Connector	Tape and reel	244630
50	Cable guide	Poly bag	244633

Please order cable guide separately.

# SMC - 1.27 mm Connectors

## CABLE ASSEMBLIES

### PRODUCT SPECIFICATION

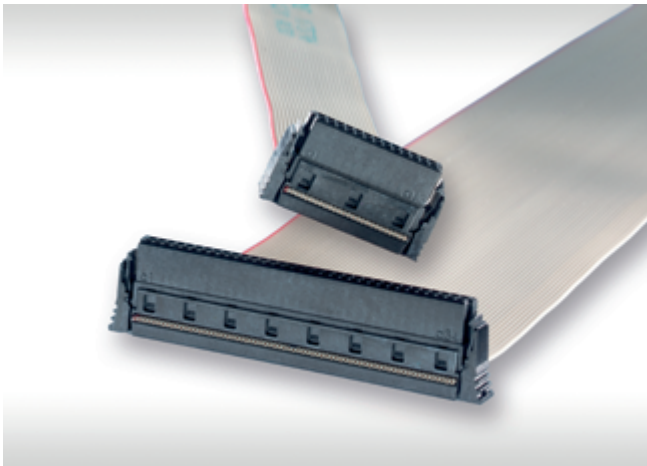

- cable assemblies with IDC female connectors
- ribbon cable AWG 30/7
- three different cable types
- assemblies with single wire or shielded wires are possible (on request)

### DIMENSIONAL DRAWINGS

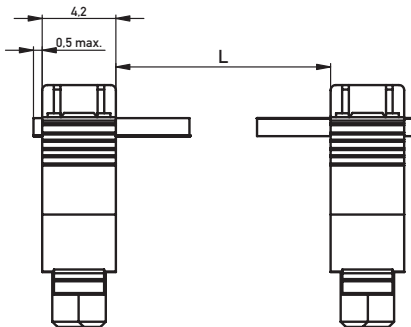
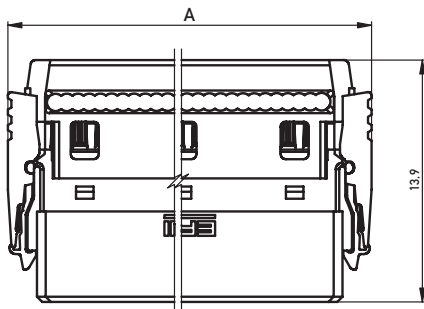
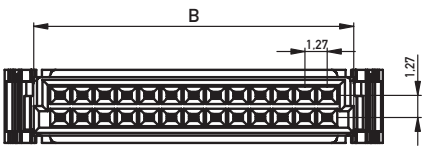

12	12.69	9.37
16	15.23	11.91
20	17.77	14.45
26	21.58	18.26
32	25.39	22.07
40	32.53	27.15
50	38.88	33.50
68	50.31	44.93
80	57.93	52.55
No. of contacts	A	B



# SMC - 1.27 mm Connectors

## CABLE ASSEMBLIES

### CONFIGURATIONS

#### Standard

Connector #1

Connector #2

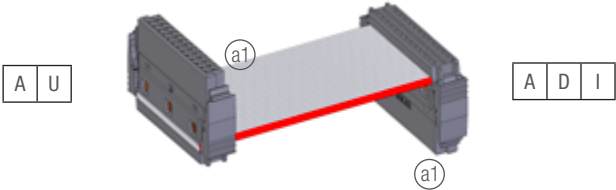
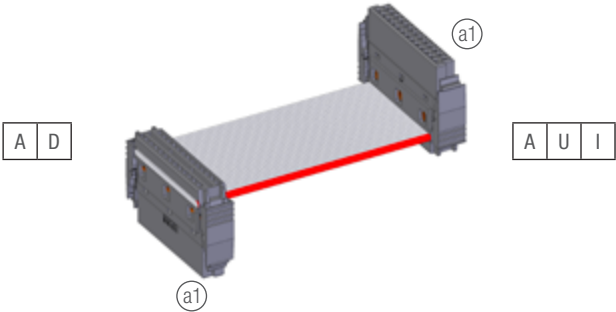
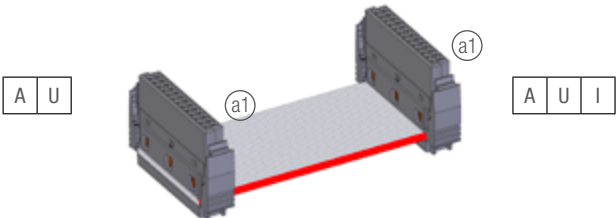

#### Crossed

Connector #2

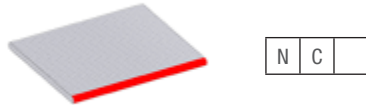
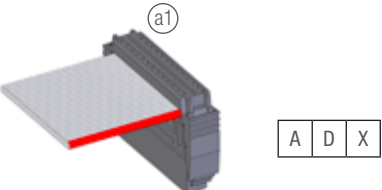
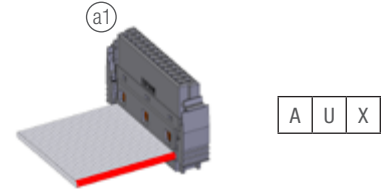

# SMC - 1.27 mm Connectors

## CABLE ASSEMBLIES



### CABLE TYPES

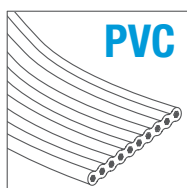
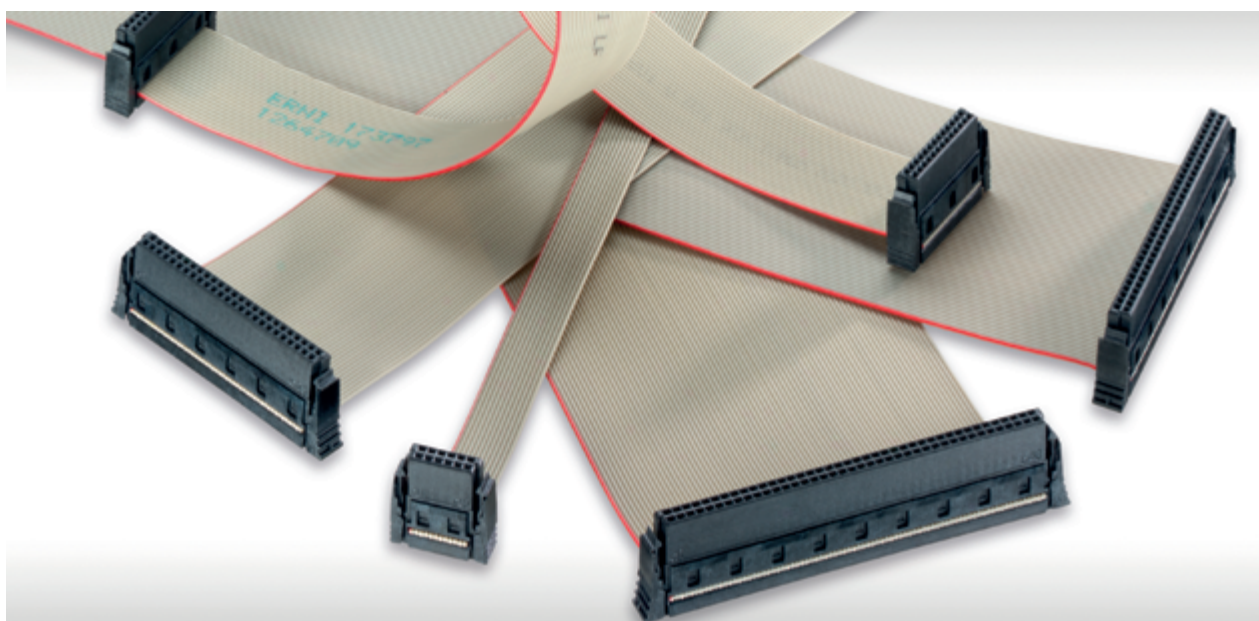

**PVC**

**Standard**

- Standard ribbon cable with PVC insulation
- AWG 30/7
- excellent abrasion and cut resistance
- temperature range: -20 °C to +105 °C (fixed)

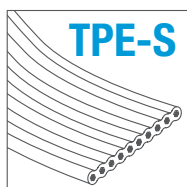

**TPE-S**

**High Temperature**

- High temperature resistant ribbon cable with TPE-S insulation
- AWG 30/7
- excellent abrasion and cut resistance
- flexible at low temperatures up to -50 °C
- temperature range: -60 °C to +125 °C (fixed)

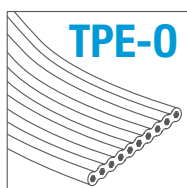

**TPE-O**

**Halogen-free**

- Halogen-free ribbon cable with TPE-O insulation
- AWG 30/7
- excellent abrasion and cut resistance
- Oil-resistant (ASTM 2)
- temperature range: -40 °C to +105 °C (fixed)

# SMC - 1.27 mm Connectors

## CABLE ASSEMBLIES

### ORDERING INFORMATION STANDARD CABLE ASSEMBLIES

IDCCS \_ SMC \_ 1.27 \_ □□ \_ □□ \_ □□□ \_ □□□□□ \_ □□

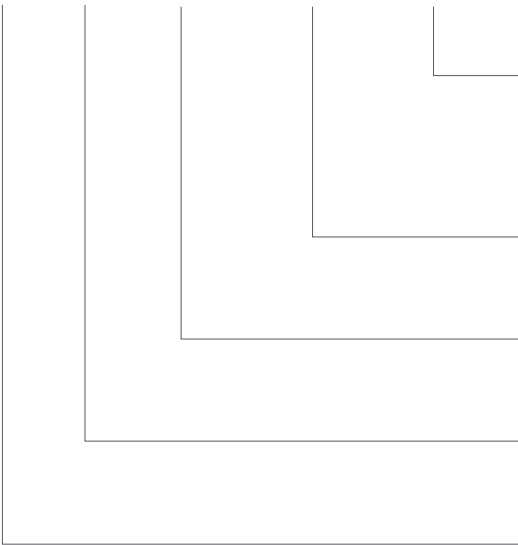

- Cable type**  
 PV: Standard (PVC)  
 HT: High temperature (TPE-S)  
 HF: Halogen-free (TPE-O)
- Length**  
 in mm
- Connector #2**  
 e.g.: AUI or AUX
- Connector #1**  
 e.g.: AU
- No. of Contacts**  
 12, 16, 20, 26, 32, 40, 50, 68, 80

**Example for a standard configuration:**

**IDCCS\_SMC\_1.27\_12\_AU\_AUI\_01000\_PV**

SMC cable assembly, 12-pin, assembled on both sides with equal connector orientation, length 1000 mm, pin assignment 1:1

# SMC - 1.27 mm Connectors

## PART NUMBER INDEX —

Part Number	Page
064002	26
064003	26
064004	26
144183	26
144185	26
154717	28
154718	28
154719	28
154720	28
154721	28
154740	21
154741	21
154742	21
154743	21
154744	21
154763	19
154764	19
154765	19
154766	19
154767	19
154805	28
154806	28
154807	28
154808	28
154809	28
204632	28

Part Number	Page
204763	29
234198	29
234199	29
234200	29
234201	29
234206	24
234207	24
234208	24
234209	24
234210	24
244628	39
244629	39
244630	39
244631	39
244632	39
244633	39
244836	23
244837	23
244838	23
244839	23
244840	23
244854	23
244855	23
244856	23
244857	23
244858	23

# SMC - 1.27 mm Connectors

## PART NUMBER INDEX —

Part Number	Page
254262	33
254273	31
254414	24
254415	24
254416	24
254417	24
254536	23
254537	23
254538	23
254539	23
254587	23
254588	23
254589	23
254590	23
354030	23
354055	28
354056	28
354057	28
354062	28
354063	28
354064	28
354065	28
354070	29
354071	29
354072	29
354073	29

Part Number	Page
354078	21
354079	21
354080	21
354081	21
354094	19
354095	19
354096	19
354097	19
354307	36
354308	36
354309	36
354310	36
354311	36
354312	36
354313	36
354314	36
354315	36
354316	36
354939	33
354939	31
364084	35
364085	35
364086	35
364087	35
364088	35
364089	35

# SMC - 1.27 mm Connectors

## PART NUMBER INDEX —

Part Number	Page
364090	35
364091	35
364092	36
364093	36
364094	35
364095	35
364096	35
364097	35
364098	35
364099	35
364100	35
364101	35
364102	35
364103	35
364715	36
354029	36
364717	36
364718	36

Part Number	Page
364719	36
364720	36
364721	36
364722	36
364723	37
364724	37
364725	37
364726	37
364727	37
364728	37
364729	37
364730	37
364731	37
364732	37
364733	37
474588	37
474589	37
484816	31, 33



**ERNI Electronics GmbH & Co. KG**

Seestrasse 9  
73099 Adelberg  
Germany  
Tel +49 7166 50-0  
Fax +49 7166 50-282  
info@erni.com  
www.erni.com

**Europe South America Africa****ERNI Electronics Inc.**

2201 Westwood Ave  
Richmond, VA 23230/USA  
Tel +1 804 228-4100  
Fax +1 804 228-4099  
info@erni.us

**North America Canada Mexico****ERNI Asia Holding Pte Ltd.**

23A Serangoon North Avenue 5  
# 04-11  
Singapore 554369  
Tel +65 6 555 5885  
Fax +65 6 555 5995  
info.eah@erni.com

**Asia Australia New Zealand****ERNI Electronics AG**

Zürichstrasse 72  
8306 Brütisellen - Zürich  
Switzerland  
Tel +41 44 835 33 83  
info@erni-electronics.ch

**Switzerland**