

0976 PFC 151

Einbausteckverbinder, M12-Kupplung für die Frontmontage, 5-polig, B-codiert, justierbar, konfektioniert mit Schaltlitze, Leiteranschlussbereich vergossen, einbauseitig M16 x 1,5-Verschraubung – besonders geeignet für Profibus –

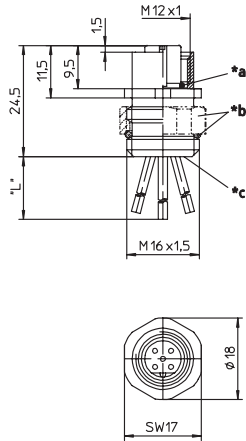

Receptacle connector, M12 female connector for front mounting, 5 poles, B coding, adjustable, assembled stranded wire, solder contacts potted with epoxy, chassis side thread M16 x 1.5 – especially suitable for Profibus –



0936 DFC 351

Einbausteckverbinder, M12-Kupplung für die Frontmontage, 5-polig, justierbar, konfektioniert mit Schaltlitze, Leiteranschlussbereich vergossen, einbauseitig M16 x 1,5-Verschraubung – besonders geeignet für DeviceNet und CANopen –



Receptacle connector, M12 female connector for front mounting, 5 poles, adjustable, assembled stranded wire, solder contacts potted with epoxy, chassis side thread M16 x 1.5 – especially suitable for DeviceNet and CANopen –

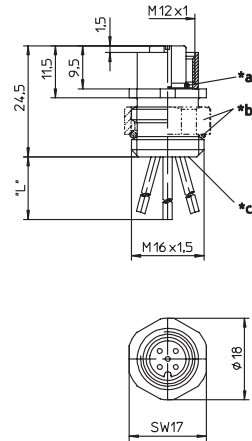

0986 EFC 151 A

Einbausteckverbinder, M12-Kupplung für die Frontmontage, 4-polig, D-codiert, justierbar, konfektioniert mit Schaltlitze, Leiteranschlussbereich vergossen, einbauseitig M16 x 1,5-Verschraubung – besonders geeignet für Industrial Ethernet –



Receptacle connector, M12 female connector for front mounting, 4 poles, D coding, adjustable, assembled stranded wire, solder contacts potted with epoxy, chassis side thread M16 x 1.5 – especially suitable for Industrial Ethernet –

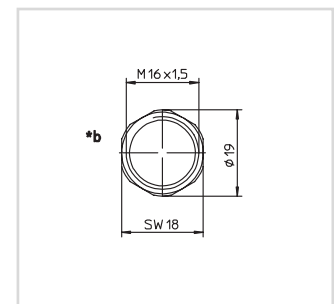
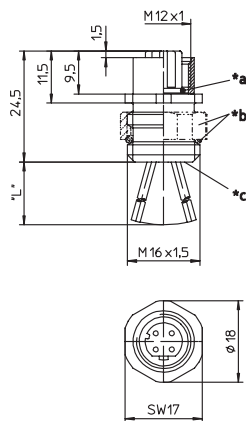

*a O-Ring
O-ring

*b Justiermutter und O-Ring lose beigestellt
adjustable nut and o-ring enclosed separately

*c Leiteranschlussbereich vergossen
solder contacts potted with epoxy
"L" 0,5 m

Pinbelegung Pin assignment

4-polig D-codiert 4 poles D coding



- 1 = gelb / yellow
- 2 = weiß / white
- 3 = orange / orange
- 4 = blau / blue

5-polig B-codiert 5 poles B coding



- 1 = braun / brown
- 2 = grün / green
- 3 = blau / blue
- 4 = rot / red
- 5 = grün/gelb / green/yellow



5-polig 5 poles



- 1 = grün / green
- 2 = rot / red
- 3 = schwarz / black
- 4 = weiß / white
- 5 = blau / blue

Technische Daten	
Umgebungstemperatur	-25°C / +80°C
Werkstoffe	
Gehäuse / Griffkörper	CuZn, vernickelt
Kontaktträger	TPU, selbstverlöschend
Kontakt	0976 PFC 151 / 0936 DFC 351: CuZn, unternickelt und 0,8 µm vergoldet 0986 EFC 151 A: CuSn, unternickelt und 0,3 µm vergoldet
O-Ring	FKM
Justiermutter	CuZn, vernickelt
Mechanische Daten	
Schutzart	IP 67 Nur im verschraubten Zustand mit den dazugehörigen Gegen- stücken.
Elektrische Daten	
Durchgangswiderstand	≤ 5 mΩ
Nennstrom bei 40°C	4 A
Nennspannung	0976 PFC 151 / 0936 DFC 351: 60 V 0986 EFC 151 A: 240 V
Prüfspannung	0976 PFC 151 / 0936 DFC 351: 1,5 kV eff. / 60 s 0986 EFC 151 A: 2,0 kV eff. / 60 s
Isolationswiderstand	> 10 ⁹ Ω
Verschmutzungsgrad	3

Technical data	
Operating temperature range	-25°C / +80°C
Materials	
Housing / Molded body	CuZn, nickel-plated
Insert	TPU, self-extinguishing
Contact	0976 PFC 151 / 0936 DFC 351: CuZn, pre-nickel and 0.8 microns gold-plated 0986 EFC 151 A: CuSn, pre-nickel and 0.3 microns gold-plated
O-ring	FKM
Adjustable nut	CuZn, nickel-plated
Mechanical data	
Degree of protection	IP 67 Only in locked position with its proper counterparts.
Electrical data	
Contact resistance	≤ 5 mΩ
Nominal current at 40°C	4 A
Nominal voltage	0976 PFC 151 / 0936 DFC 351: 60 V 0986 EFC 151 A: 240 V
Test voltage	0976 PFC 151 / 0936 DFC 351: 1.5 kV eff. / 60 s 0986 EFC 151 A: 2.0 kV eff. / 60 s
Insulation resistance	> 10 ⁹ Ω
Pollution degree	3

Bestellbezeichnung Designation	Polzahl Poles	Leiter (mm ²) Lead (mm ²)	
0986 EFC 151 A	4D	AWG 22	
0976 PFC 151	5B	1 x 0.5 / 4 x AWG 22	 
0936 DFC 351	5	0.22	