

EBT007

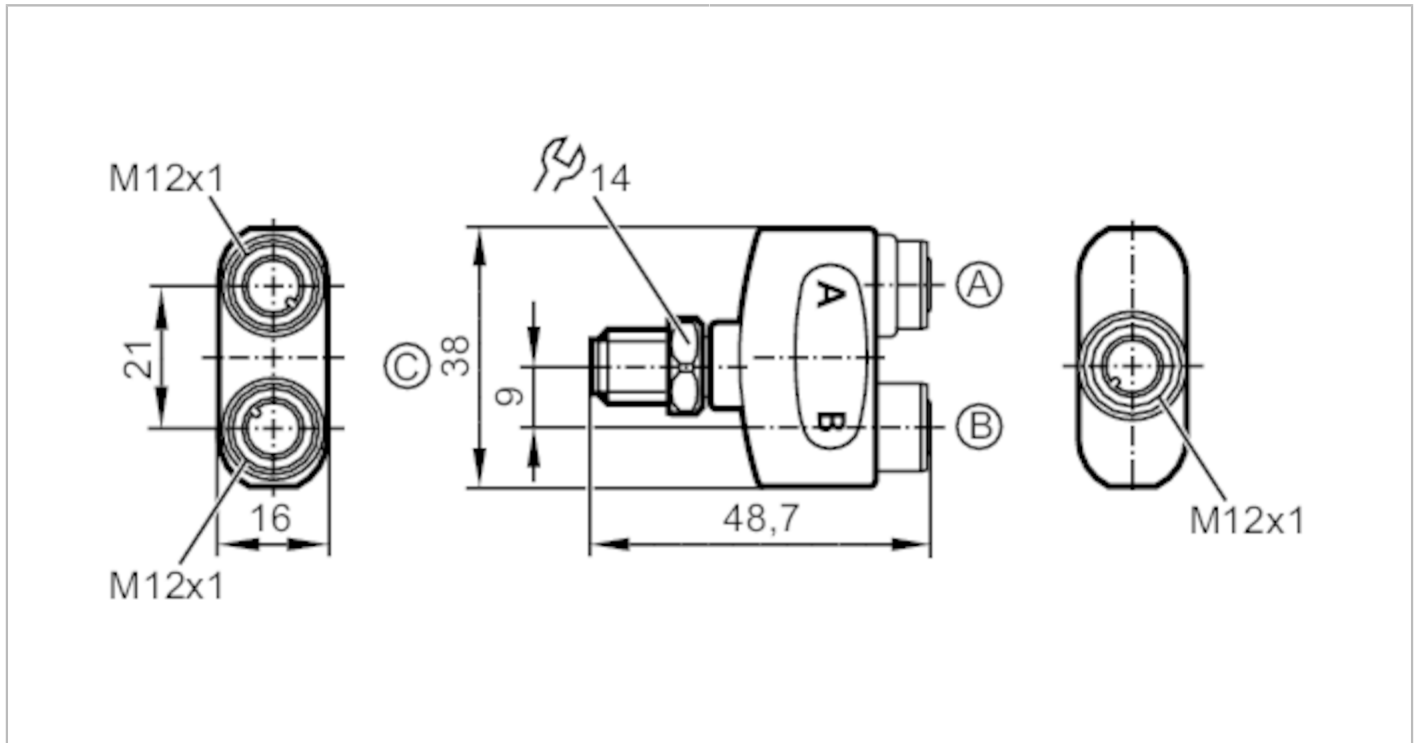

Y-splitter

ZDO2H050VAS0000-00STGH050VAS



Application	
Special feature	Free from silicone; Gold-plated contacts
Free from silicone	yes
Electrical data	
Operating voltage [V]	< 60 AC/DC
Protection class	II
Max. current load per module/slot [A]	4
Max. current load total [A]	4
Operating conditions	
Ambient temperature [°C]	-25...100
Protection	IP 65; IP 67; IP 68; IP 69K
Mechanical data	
Weight [g]	35.6
Materials	housing: PA orange; Sealing: EPDM
Material nut	stainless steel (1.4404 / 316L) / stainless steel (1.4404 / 316L)
Remarks	
Pack quantity	1 pcs.
Electrical connection - plug	
Connector: 1 x M12; Locking: stainless steel (1.4404 / 316L); Contacts: gold-plated; Tightening torque: 0.6...1.5 Nm	

EBT007



Y-splitter

ZDO2H050VAS0000-00STGH050VAS

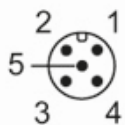

Connection

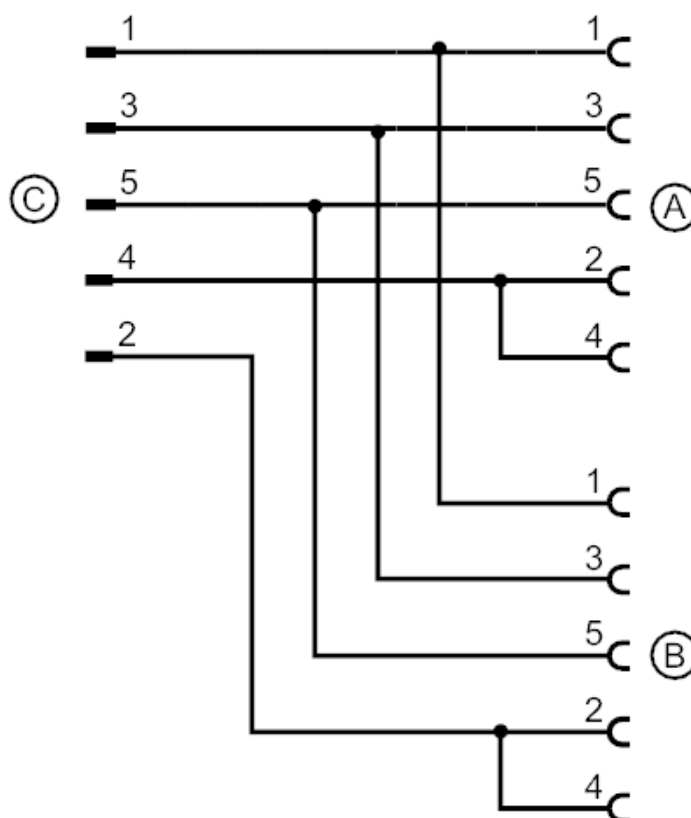

connection to IEC 61076-2-101

Electrical connection - socket

Connector: 2 x M12; Locking: stainless steel (1.4404 / 316L); Contacts: gold-plated; Tightening torque: 0.6...1.5 Nm

