

M8 MALE 90° , SHIELDED

PVC 3X0.34 shielded GRAY, UL,CSA 5m

M8

Male 90°

3-pole, shielded

Plastic housings with good resistance against chemicals and oils. The resistance to aggressive media should be individually tested for your application. Further details on request.

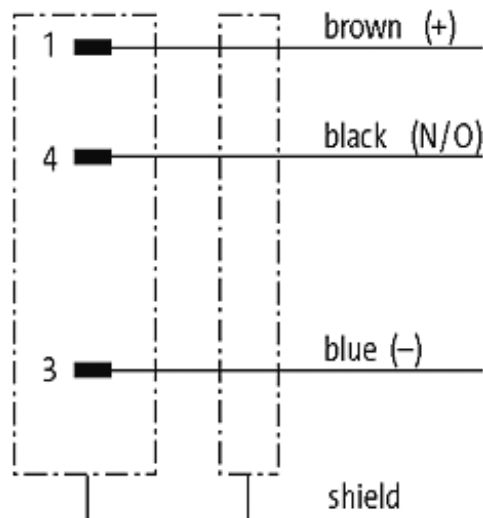
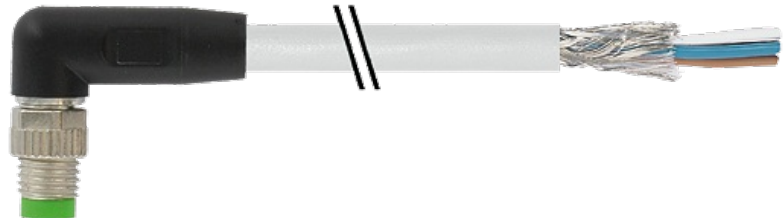
[Link to Product](#)**Illustration**

Male

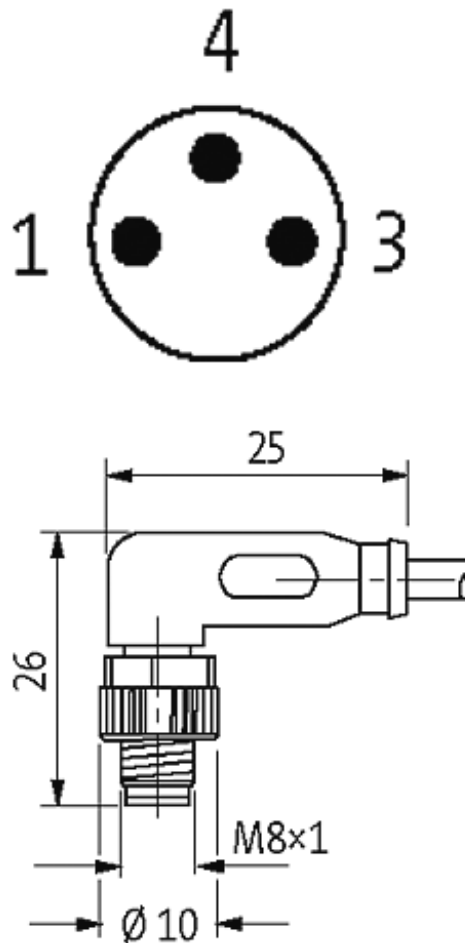

Product may differ from Image

Approvals



Form

08721

Technical Data

Operating voltage	max. 60 V AC/DC
Operating current per contact	max. 4 A
Locking of ports	Screw thread M8 × 1 mm (recommended torque 0.4 Nm) self-securing
Protection	IP67 inserted and tightened (EN 60529)

Cables

Cable number	200
--------------	-----

No./diameter of wires	3 × 0.34 mm ²
Wire isolation	PVC (br, bl, bk)
Jacket Color	gray
Shore hardness outer jacket	85 ± 5A
Material (jacket)	PVC (UL/CSA)
Outer diameter	approx. 5.0 mm
Bend radius (fixed)	10 × outer Ø
Bend radius (moving)	10 × outer Ø
Temperature range (fixed)	-30...+80 °C
Temperature range (mobile)	-5...+80 °C
Shielded	yes

General data

Temperature range	-25...+85 °C, depending on cable quality
-------------------	--

Commercial data

country of origin	DE
customs tariff number	85444290
minimum order quantity	1