

M12 male 0° / M12 female 90° DeviceNet

PUR AWG24+AWG22 shielded vt UL/CSA+drag ch. 0,6m

DeviceNet, CANopen

Male straight to female 90°

M12 - M12

5-pole, shielded

Plastic housings with good resistance against chemicals and oils. The resistance to aggressive media should be individually tested for your application. Further details on request. Further cable lengths on request.

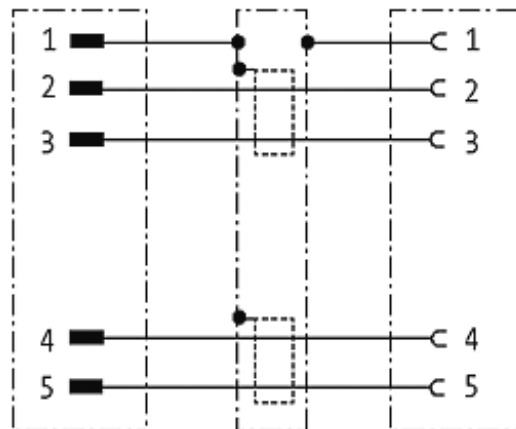
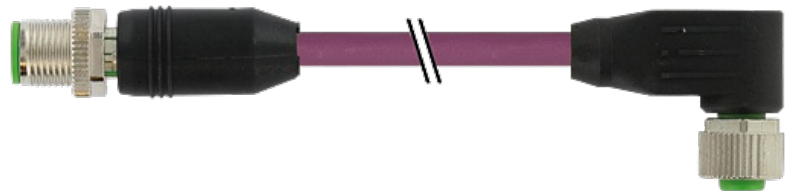
[Link to Product](#)**Illustration**

Male

Female

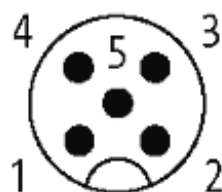

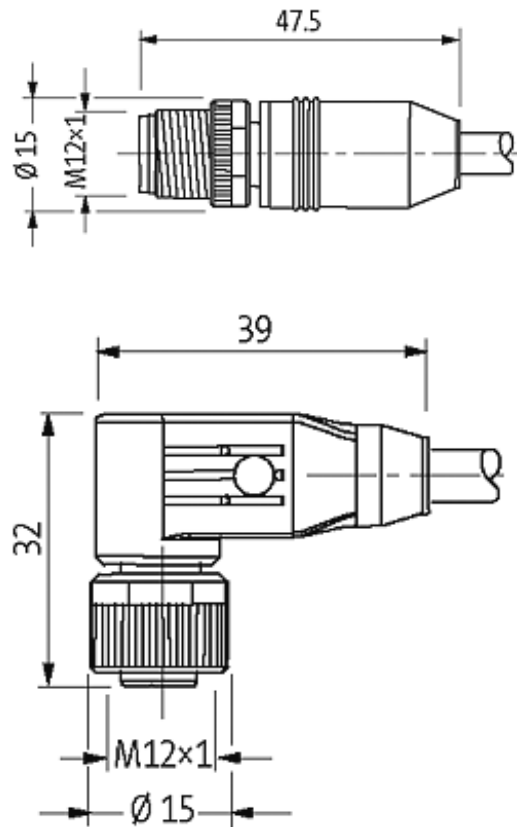

Product may differ from Image