

7/8" male 90° / 7/8" female 90°

PUR 5x1.0 gy 5m

Male 90° to female 90°

7/8" - 7/8"

Power cable

5-pole

Further cable lengths on request. Plastic housings with good resistance against chemicals and oils. The resistance to aggressive media should be individually tested for your application. Further details on request.

[Link to Product](#)

Illustration

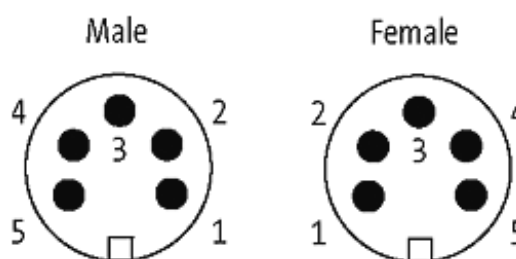
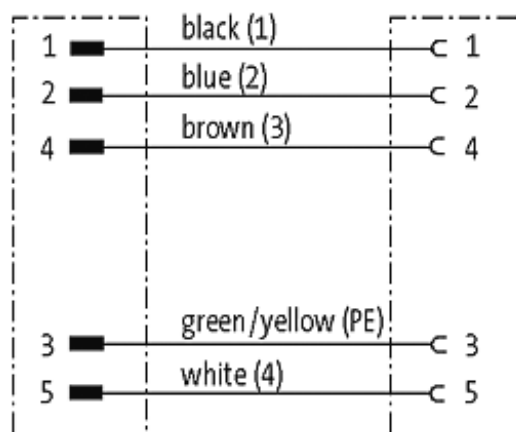
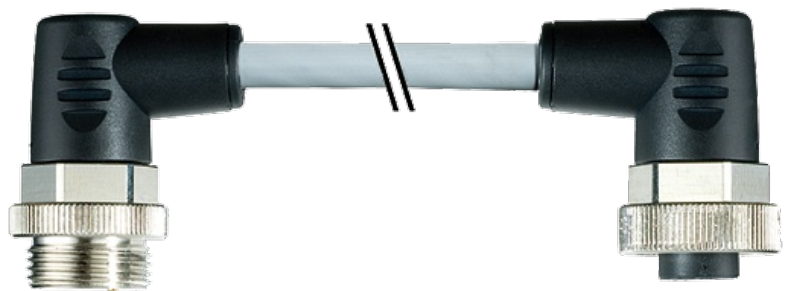

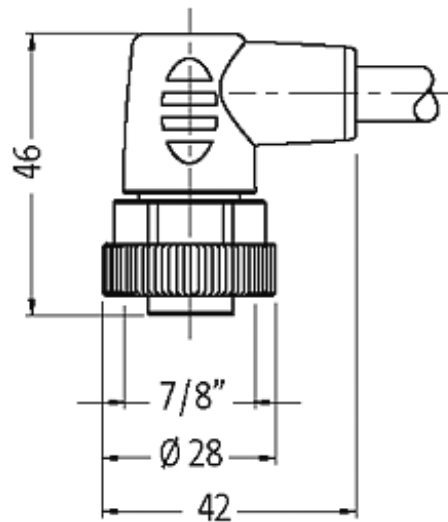
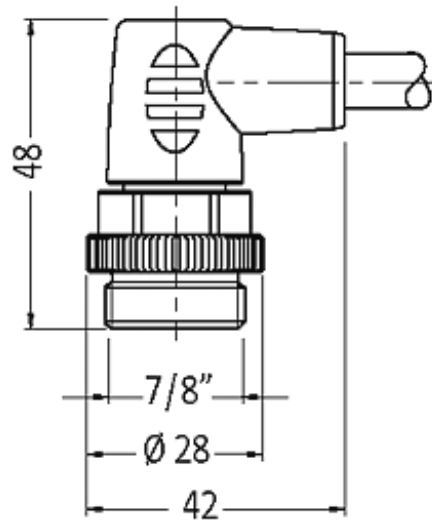

Product may differ from Image

Approvals



Form

50051

Technical Data

Operating voltage	max. 230/400 V AC/DC
Operating current per contact	max. 12 A
Locking of ports	Screw thread 7/8" (recommended torque 1.5 Nm) self-securing
Protection	IP67 inserted and tightened (EN 60529)

Cables

Cable number	965
No./diameter of wires	5 × 1.0 mm ²

The information in this brochure has been compiled with the utmost care.

Liability for the correctness completeness and topicality of the information is restricted to gross negligence. Version: 05/15

Murrelektronik GmbH | Falkenstraße 3, 71570 Oppenweiler | Fon +49 (71 91) 47-0, Fax +49 (71 91) 47-491000 | shop@murrelektronik.de | shop.murrelektronik.de

Wire isolation	PVC (br, wh, bl, bk, gnye)
Jacket Color	gray
Shore hardness outer jacket	90 ± 5A
Material (jacket)	PUR/PVC
Outer diameter	approx. 7.2 mm
Bend radius (fixed)	7.5 × outer Ø
Bend radius (moving)	10 × outer Ø
Temperature range (fixed)	-30...+70 °C
Temperature range (mobile)	-5...+70 °C

Commercial data

country of origin	CZ
customs tariff number	85444290
minimum order quantity	1