

# SANMOTION

STEPPING SYSTEMS

# STEPPING MOTOR WITH ENCODER



SANYO DENKI

Ver.2

STEPPING SYSTEMS

# STEPPING MOTOR WITH ENCODER



Standard Models



Quick Customization Service

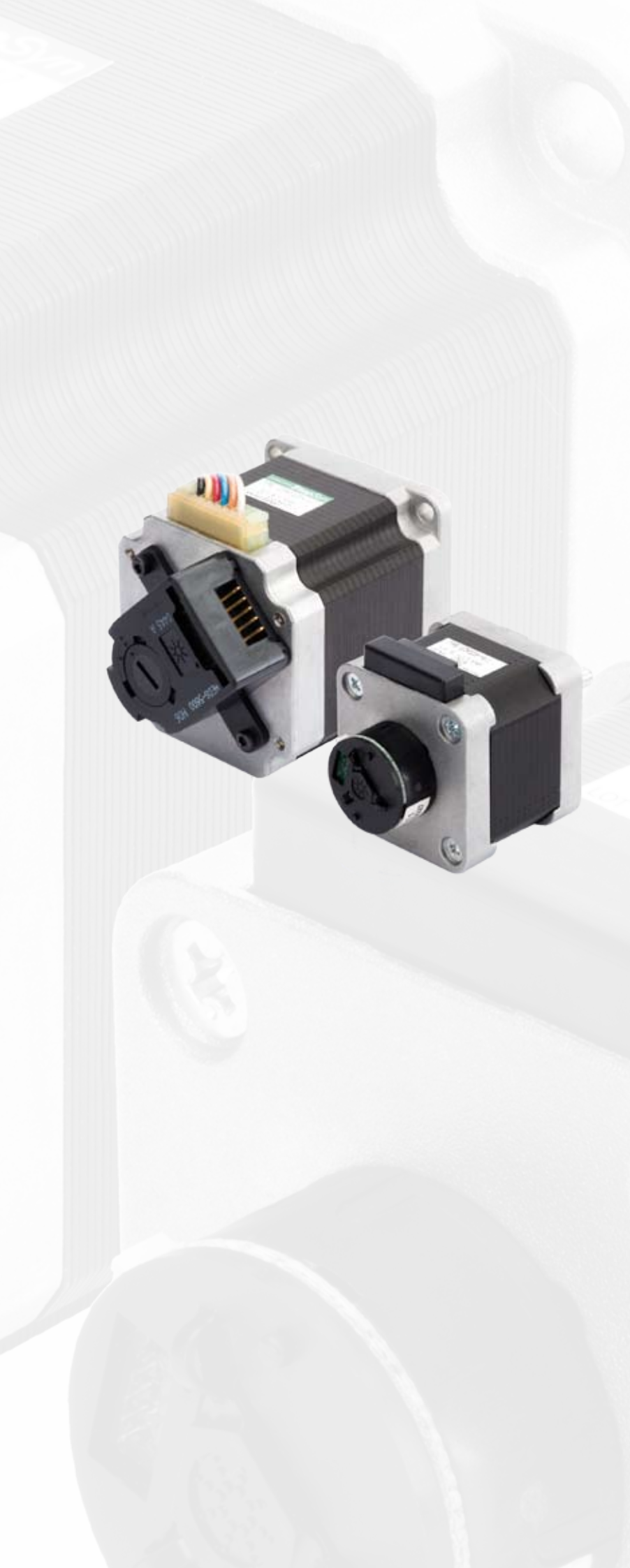

## Contents

|                                |      |
|--------------------------------|------|
| Features .....                 | p. 4 |
| Application examples .....     | p. 5 |
| Stepping motors lineup .....   | p. 5 |
| Encoder selection guide .....  | p. 5 |
| How to read part numbers ..... | p. 6 |
| Part numbers available .....   | p. 7 |

## Standard Models

|                                     |       |
|-------------------------------------|-------|
| 35mm. sq models .....               | p. 8  |
| 42mm. sq models .....               | p. 10 |
| 56mm. sq models .....               | p. 13 |
| 60mm. sq models .....               | p. 16 |
| 86mm. sq models .....               | p. 18 |
| Encoder specifications .....        | p. 20 |
| Type R .....                        | p. 20 |
| Type S .....                        | p. 21 |
| Type M.....                         | p. 22 |
| Type L .....                        | p. 23 |
| General specifications .....        | p. 24 |
| Wiring and rotation direction ..... | p. 25 |

## Quick Customization Service

|                              |       |
|------------------------------|-------|
| Easy customization .....     | p. 26 |
| Quick customization .....    | p. 27 |
| Customization examples ..... | p. 27 |
| Inquiry Check Sheet .....    | p. 28 |

# STEPPING MOTOR WITH ENCODER

## When open-loop control is not enough

Stepping systems provide precise positioning with easy control. By adding an encoder to a stepping motor, the controller can monitor the actual position directly, closing the feedback loop and improving the safety and reliability.

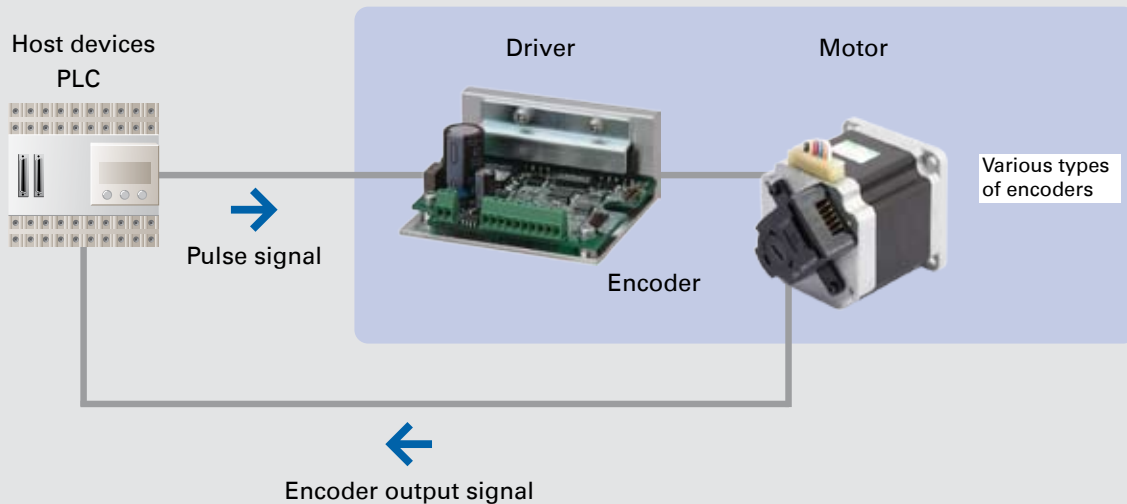

## Stepping Motor with Encoder: Features

### Safety: Position verification

Adding an encoder is an ideal and easy solution for safety-sensitive applications, requiring position verification and position maintenance, such as medical instrumentation.

### Close-loop control with stepper benefit

High-end close loop control can be achieved while keeping the advantages of stepping motors: stable stop without hunting, higher torque than DC servo motor at low speed over the same size, eliminating the need of gearboxes.

### Reliability: Stall Detection

Device reliability is improved with possible detection and reporting of stalls.

### Accurate Homing

Encoder with index pulse option can be used to achieve precise homing.



We also provide quick customization service to meet your particular need. Contact our sales office for information.

Quick Customization Service ▶ p. 26  
Inquiry Check Sheet ▶ p. 28

# Application Examples



Blood Analyser

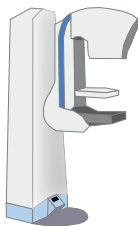

Mammograph

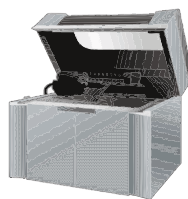







3D Printing







Industrial machine

## Stepping Motors: Lineup RoHS

| Basic step angle | Motor size |   | Holding torque [Nm min.]<br>Model number | Page  |
|------------------|------------|---|--|-------|
| 1.8°             | 35 mm sq.  |    | 0.195 to 0.23<br>2H35□                   | p. 8  |
| 0.9°             | 42 mm sq.  |    | 0.23<br>2P42□                            | p. 10 |
| 1.8°             | 42 mm sq.  |   | 0.26 to 0.42<br>2H42□                    | p. 10 |
| 1.8°             | 56 mm sq.  |  | 0.83 to 2<br>2H56□                       | p. 13 |
| 1.8°             | 60 mm sq.  |  | 0.88 to 2.7<br>2H60□                     | p. 16 |
| 1.8°             | 86 mm sq.  |  | 3.3 to 9<br>2H86□                        | p. 18 |

## Encoder Selection Guide RoHS

4 types of encoder can be selected. They are two and three channels optical incremental encoders and emphasize high reliability and high resolution.

| Encoder type             |  | Counts Per Revolution [CPR] |     |      |      | Pulse index option | Single ended | Differential line driver | Key points   |
|--------------------------|---|-----------------------------|-----|------|------|--------------------|--------------|--------------------------|--|
|                          |   | 200                         | 400 | 1000 | 1024 |                    |              |                          |  |
| <b>R</b> <sub>type</sub> |  | ■                           |     |      |      |                    | ■            |                          | Compact size<br>Simple interface<br>Cost effective                 |
| <b>S</b> <sub>type</sub> |  |                             | ■   |      |      | ■                  | ■            |                          | Medium resolution<br>Pulse index option<br>Simple interface        |
| <b>M</b> <sub>type</sub> |  |                             |     | ■    | ■    | ■                  | ■            |                          | High resolution<br>Pulse index option<br>Simple interface          |
| <b>L</b> <sub>type</sub> |  |                             | ■   |      |      |                    |              | ■                        | Noise immunity<br>Transmitting encoder signal over a long distance |

Encoder specifications ▶ p. 20 to 23  
Please consult us for higher resolution encoder

# How to Read Part Numbers

Note that not every combination of the following codes or characters is available. Check the part numbers available on the following or contact us.

Example: This is a standard model number for a stepping motor and encoder. The motor specifications are 2-phase stepping motor, motor size: 56mm sq., motor length: 54mm, bipolar winding, 2A/phase, S type encoder, 2 channels, 400 CPR.

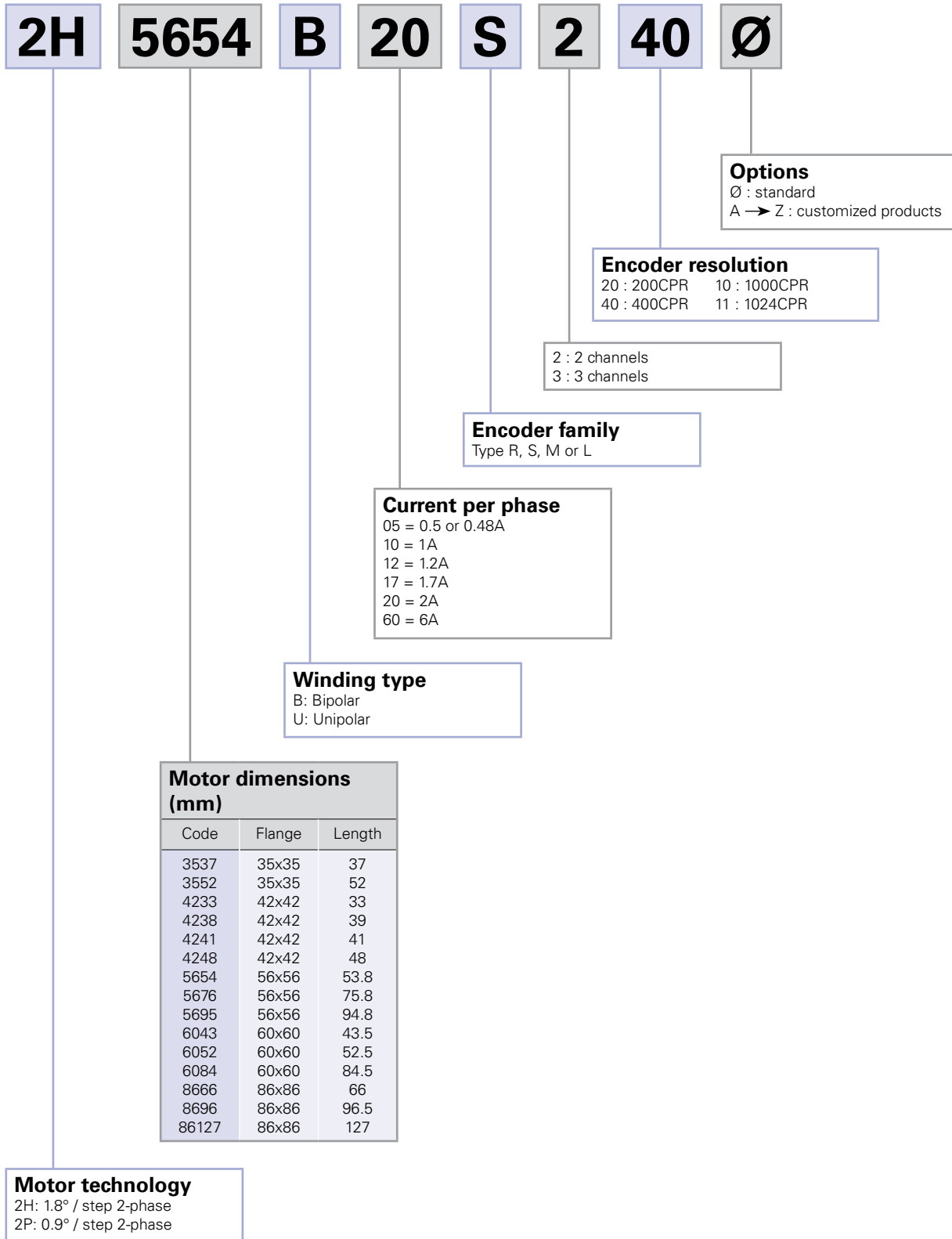

# Part Numbers Available

On above table are introduced available combinations between stepping motors and encoders.

■ : Valid combinations, available from stock

| Motor size | Based motor | Encoder type |            |            |            |         |            |            |        |
|------------|-------------|--------------|------------|------------|------------|---------|------------|------------|--------|
|            |             | R type       | S type     |            |            | M type  |            |            | L type |
|            |             | 2 channels   | 2 channels | 3 channels | 2 channels |         | 3 channels | 2 channels |        |
|            |             | 200CPR       | 400CPR     | 400CPR     | 1000CPR    | 1024CPR | 1000CPR    | 400CPR     |        |
|            |             | R220         | S240       | S340       | M210       | M211    | M310       | L240       |        |
| 35 mm sq.  | 2H3537B12   | ■            | ■          | ■          | ■          | ■       | ■          |            |        |
|            | 2H3552U12   | ■            | ■          | ■          | ■          | ■       | ■          |            |        |
| 42 mm sq.  | 2P4233B10   |              | ■          | ■          | ■          | ■       | ■          |            |        |
|            | 2H4233B05   | ■            | ■          | ■          | ■          | ■       | ■          |            |        |
|            | 2H4238B17   | ■            | ■          | ■          | ■          | ■       | ■          |            |        |
|            | 2H4241B05   |              | ■          | ■          | ■          | ■       | ■          |            |        |
|            | 2H4241U12   |              | ■          | ■          | ■          | ■       | ■          |            |        |
|            | 2H4248U12   | ■            | ■          | ■          | ■          | ■       | ■          |            |        |
| 56 mm sq.  | 2H5654U10   | ■            | ■          | ■          | ■          | ■       |            | ■          |        |
|            | 2H5654U20   | ■            | ■          | ■          | ■          | ■       |            | ■          |        |
|            | 2H5654B20   |              | ■          | ■          | ■          | ■       |            | ■          |        |
|            | 2H5676B20   |              | ■          | ■          | ■          | ■       |            | ■          |        |
|            | 2H5695B20   | ■            | ■          | ■          | ■          | ■       |            | ■          |        |
| 60 mm sq.  | 2H6043B20   | ■            | ■          | ■          | ■          | ■       |            | ■          |        |
|            | 2H6052B20   | ■            | ■          | ■          | ■          | ■       |            | ■          |        |
|            | 2H6084B20   | ■            | ■          | ■          | ■          | ■       |            | ■          |        |
| 86 mm sq.  | 2H8666B60   | ■            | ■          | ■          | ■          | ■       |            | ■          |        |
|            | 2H8696B60   | ■            | ■          | ■          | ■          | ■       |            | ■          |        |
|            | 2H86127B60  | ■            | ■          | ■          | ■          | ■       |            | ■          |        |

## Optional Cables

### Motor cables

| Motor size | Based motor | Cable P/N |
|------------|-------------|-----------|
| 42 mm sq.  | 2H4233B05   | 4835728-1 |
|            | 2H4238B17   | 4835728-1 |
|            | 2H4241B05   | 4835728-1 |
|            | 2H4241U12   | 4835710-1 |
|            | 2H4248U12   | 4835710-1 |

### Encoder cables

| Encoder      | Motor type       | Cable P/N |
|--------------|------------------|-----------|
| R220         | 2H35, 2H42       | CRP12500  |
|              | 2H56, 2H60, 2H86 | CRS22500  |
| S240<br>M21x | all              | CS2500    |
| S340<br>M310 | all              | CS3500    |





**2H3552U12R220**

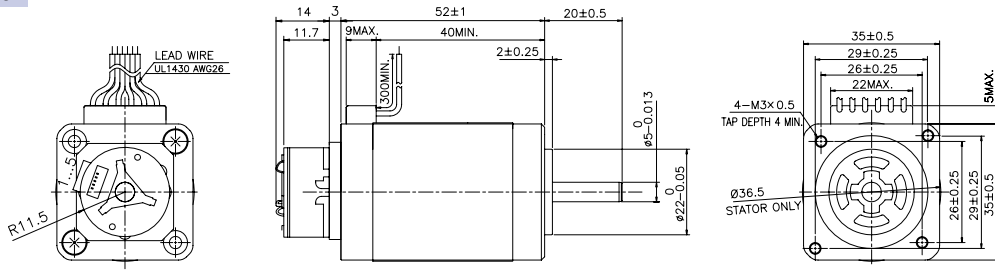

**2H3552U12Sxxx  
2H3552U12Mxxx**

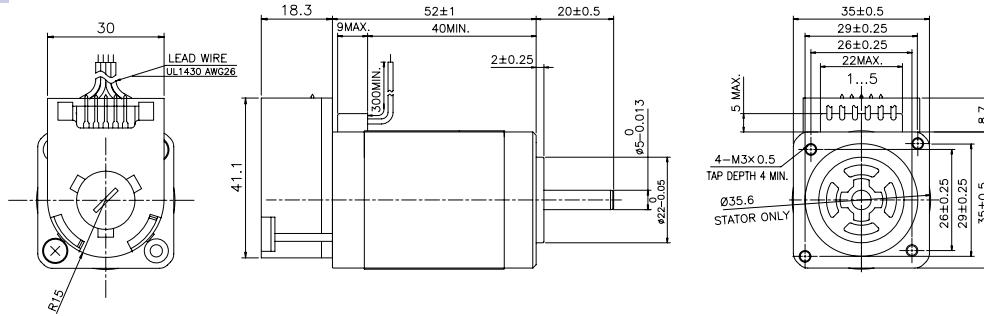

**Internal wiring**

Unipolar winding

Bipolar winding

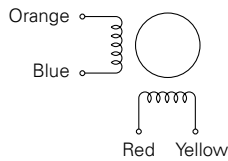
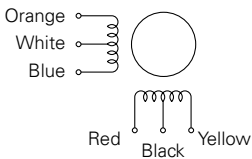

General Specification ▶ p. 24  
Rotation Direction ▶ p. 25

**Encoder cables**

R220 Encoder, Cable P/N: CRP12500

Manufacturer: MOLEX  
Housing: 51021-0500  
Terminal: 50079-8000 or 8100

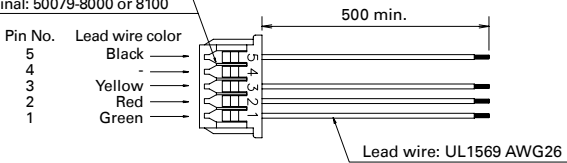

S240, M21x Encoder, Cable P/N: CS2500

Manufacturer: MOLEX  
Housing: 22-01-2055  
(locking ramp cut)

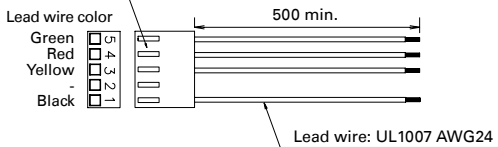

S340, M310 Encoder, Cable P/N: CS3500

Manufacturer: MOLEX  
Housing: 22-01-2055  
(locking ramp cut)

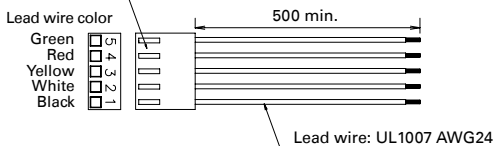

35mm sq.

42mm sq.

56mm sq.

60mm sq.

86mm sq.

Encoder Specifications

Customization Service

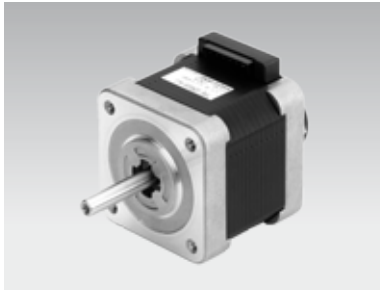

## 42 mm sq.

0.9° - 1.8° /step RoHS

Unipolar and Bipolar winding  
Lead wire and Connector type

| Based motor      | Holding torque at 2-phase energization | Step angle ° | Winding type | Rated current A/phase | Wiring resistance Ω /phase | Winding inductance mH/phase | Rotor Inertia [x 10 <sup>-4</sup> kg.m <sup>2</sup> ] | Weight kg | Optional motor cable |
|------------------|--|--------------|--------------|-----------------------|----------------------------|-----------------------------|---|-----------|----------------------|
|                  | [N.m min.]                             |              |              |                       |                            |                             |   |           |                      |
| <b>2P4233B10</b> | 0.23                                   | 0.9          | Bipolar      | 1                     | 3.3                        | 8.0                         | 0.044   | 0.24      | -                    |
| <b>2H4233B05</b> | 0.26                                   | 1.8          | Bipolar      | 0.48                  | 14                         | 27                          | 0.036   | 0.23      | 4835728-1            |
| <b>2H4238B17</b> | 0.39                                   | 1.8          | Bipolar      | 1.7                   | 1.3                        | 3.4                         | 0.056   | 0.29      | 4835728-1            |
| <b>2H4241B05</b> | 0.42                                   | 1.8          | Bipolar      | 0.5                   | 18                         | 42                          | 0.062   | 0.31      | 4835728-1            |
| <b>2H4241U12</b> | 0.32                                   | 1.8          | Unipolar     | 1.2                   | 3                          | 3.9                         | 0.062   | 0.31      | 4835710-1            |
| <b>2H4248U12</b> | 0.37                                   | 1.8          | Unipolar     | 1.2                   | 3.3                        | 3.4                         | 0.074   | 0.37      | 4835710-1            |

### Dynamic performances

#### 2P4233B10

Driver: Internal circuit  
Power supply: — 36V — 24V  
Current: 1A/phase bipolar  
Excitation mode: Full-step  
Load inertia JL = 0.94x10<sup>-4</sup>kg.m<sup>2</sup> (rubber coupling)

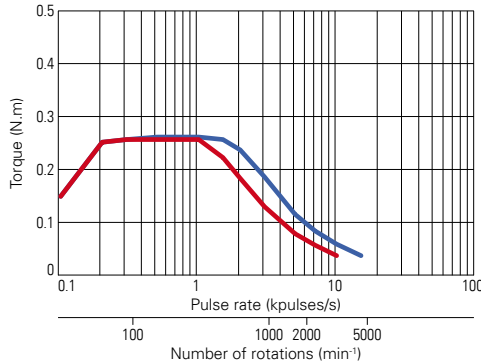

#### 2H4233B05

Driver: Internal circuit  
Power supply: — 36V — 24V  
Current: 0.48A/phase bipolar  
Excitation mode: Full-step  
Load inertia JL = 0.94x10<sup>-4</sup>kg.m<sup>2</sup> (rubber coupling)

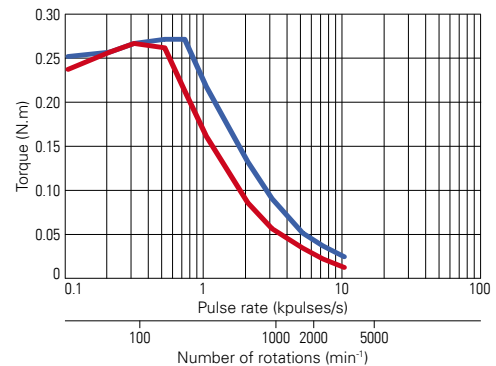

#### 2H4238B17

Driver: BS1D200P10  
Power supply: — 36VDC — 24VDC  
Current: 1.7A/phase bipolar  
Excitation mode: Full-step  
Load inertia JL = 0.94x10<sup>-4</sup>kg.m<sup>2</sup> (rubber coupling)

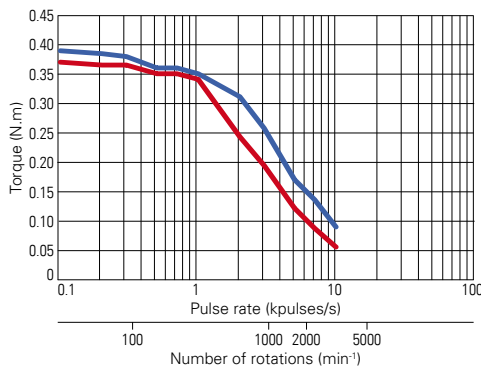

#### 2H4241B05

Driver: Internal circuit  
Power supply: — 36V — 24V  
Current: 0.5A/phase bipolar  
Excitation mode: Full-step  
Load inertia JL = 0.94x10<sup>-4</sup>kg.m<sup>2</sup> (rubber coupling)

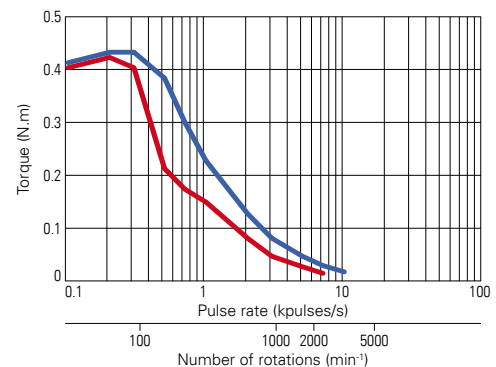

### 2H4241U12

Driver: US1D200P10  
 Power supply: — 36V — 24V  
 Current: 1.2A/phase unipolar  
 Excitation mode: Full-step  
 Load inertia JL = 0.94x10<sup>-4</sup>kg.m<sup>2</sup> (rubber coupling)

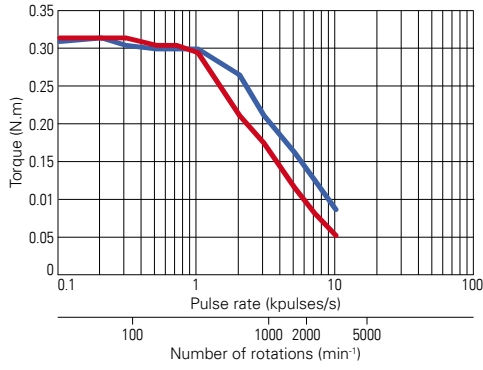

### 2H4248U12

Driver: US1D200P10  
 Power supply: — 36V — 24V  
 Current: 1.2A/phase unipolar  
 Excitation mode: Full-step  
 Load inertia JL = 0.94x10<sup>-4</sup>kg.m<sup>2</sup> (rubber coupling)

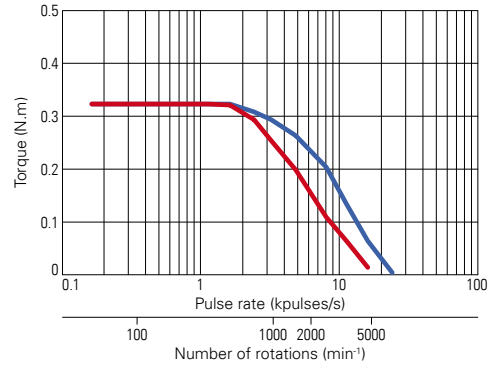

## Dimensions [Unit: mm]

2P4233B10Sx40  
 2P4233B10Mx1x

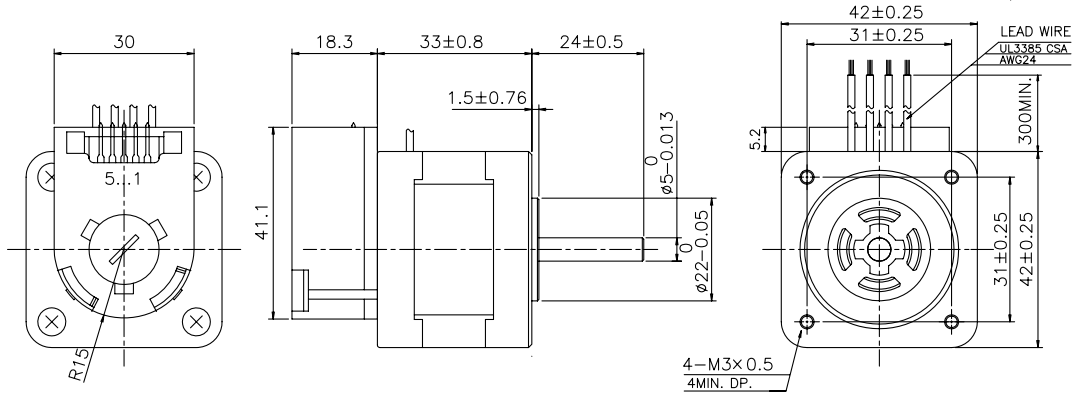

2H42xxxxR220

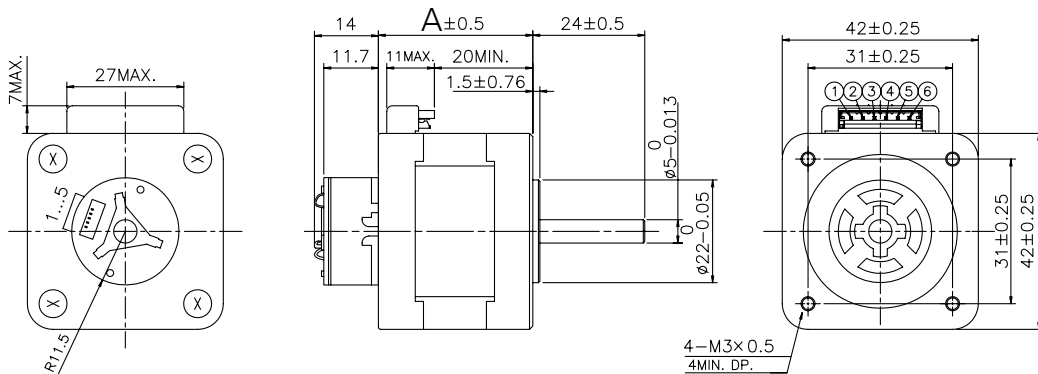

| Motor Length | A [mm] |
|--------------|--------|
| 2H4233       | 33     |
| 2H4238       | 39     |
| 2H4248       | 48     |

35mm sq.

42mm sq.

56mm sq.

60mm sq.

86mm sq.

Encoder Specifications

Customization Service

**2H42xxxxSx40**  
**2H42xxxxMx1x**

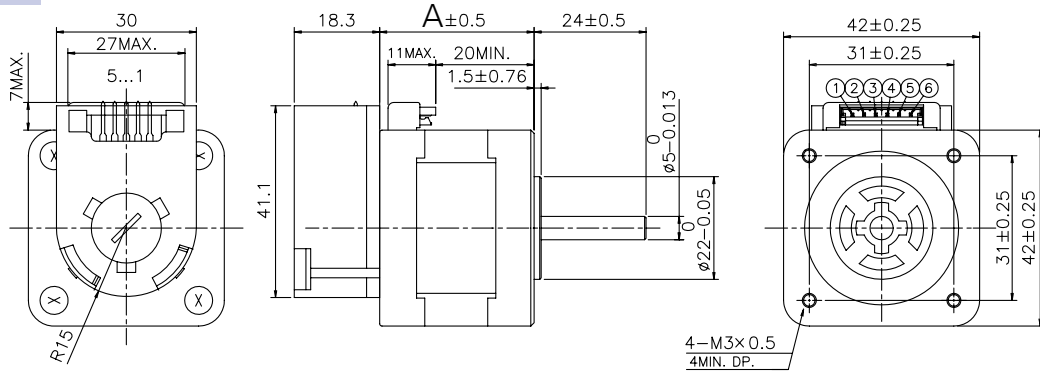

| Motor Length | A [mm] |
|--------------|--------|
| 2H4233       | 33     |
| 2H4238       | 39     |
| 2H4241       | 41     |
| 2H4248       | 48     |

**Internal wiring**

( ) connector pin number

Unipolar winding

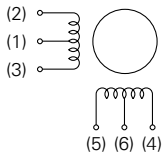

Bipolar winding

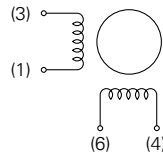

General Specification ▶ p. 24

Rotation Direction ▶ p. 25

**Motor cables**

Unipolar winding, Cable P/N: 4835710-1

Manufacturer: J.S.T. Mfg. Co., Ltd.  
 Housing: EHR-6 Black  
 Pin: SEH-001T-P0.6

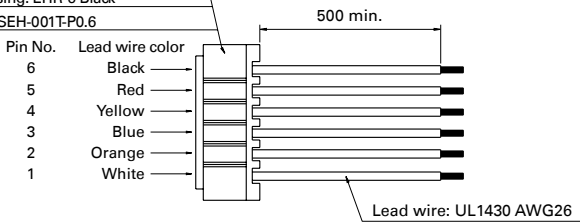

Bipolar winding, Cable P/N: 4835728-1

Manufacturer: J.S.T. Mfg. Co., Ltd.  
 Housing: EHR-6 Black  
 Pin: SEH-001T-P0.6

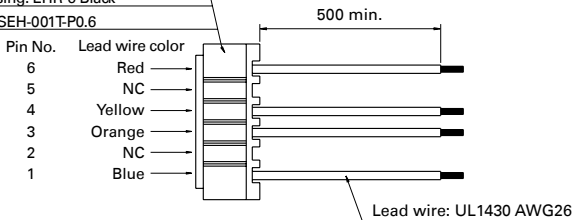

**Encoder cables**

R220 Encoder, Cable P/N: CRP12500

Manufacturer: MOLEX  
 Housing: 51021-0500  
 Terminal: 50079-8000 or 8100

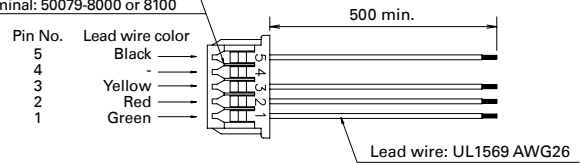

S2xx, M2xx Encoder, Cable P/N: CS2500

Manufacturer: MOLEX  
 Housing: 22-01-2055  
 (locking ramp cut)

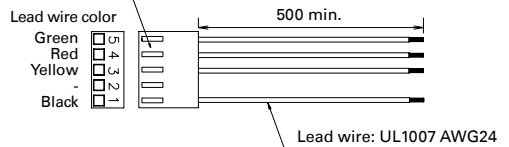

S3xx, M3xx Encoder, Cable P/N: CS3500

Manufacturer: MOLEX  
 Housing: 22-01-2055  
 (locking ramp cut)

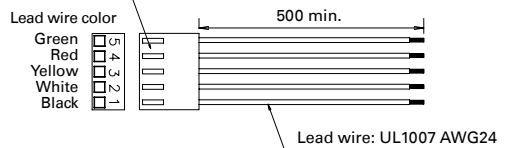



## 56 mm sq.

1.8° /step RoHS

Unipolar and Bipolar winding  
Lead wire type

| Based motor      | Holding torque at 2-phase energization [N.m min.] | Step angle ° | Winding type | Rated current A/phase | Wiring resistance Ω /phase | Winding inductance mH/phase | Rotor Inertia [x 10 <sup>-4</sup> kg.m <sup>2</sup> ] | Weight kg | Optional motor cable |
|------------------|---|--------------|--------------|-----------------------|----------------------------|-----------------------------|---|-----------|----------------------|
| <b>2H5654U10</b> | 0.83  | 1.8          | Unipolar     | 1                     | 6.7                        | 15                          | 0.21  | 0.65      | -                    |
| <b>2H5654U20</b> | 0.83  | 1.8          | Unipolar     | 2                     | 1.6                        | 3.8                         | 0.21  | 0.65      | -                    |
| <b>2H5654B20</b> | 0.83  | 1.8          | Bipolar      | 2                     | 0.8                        | 3.8                         | 0.21  | 0.65      | -                    |
| <b>2H5676B20</b> | 1.27  | 1.8          | Bipolar      | 2                     | 1.05                       | 4.5                         | 0.36  | 0.98      | -                    |
| <b>2H5695B20</b> | 2   | 1.8          | Bipolar      | 2                     | 2.3                        | 10.4                        | 0.49  | 1.3       | -                    |

### Dynamic performances

#### 2H5654U10

Driver: Internal circuit  
Power supply: — 36V — 24V  
Current: 1A/phase unipolar  
Excitation mode: Full-step  
Load inertia JL = 2.6x10<sup>-4</sup>kg.m<sup>2</sup> (rubber coupling)

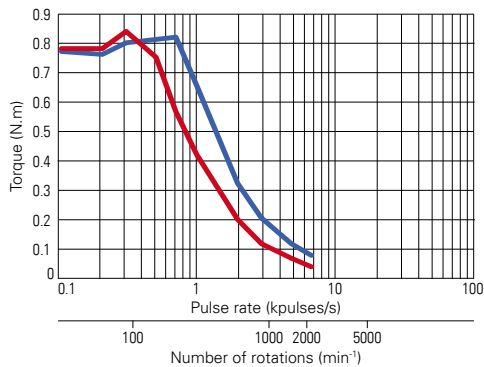

#### 2H5654U20

Driver: US1D200P10  
Power supply: — 36V — 24V  
Current: 2A/phase bipolar  
Excitation mode: Full-step  
Load inertia JL = 0.94x10<sup>-4</sup>kg.m<sup>2</sup> (rubber coupling)

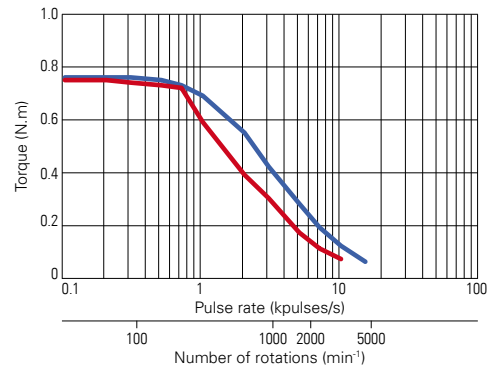

#### 2H5654B20

Driver: BS1D200P10  
Power supply: — 36VDC — 24VDC  
Current: 2A/phase bipolar  
Excitation mode: Full-step  
Load inertia JL = 2.6x10<sup>-4</sup>kg.m<sup>2</sup> (rubber coupling)

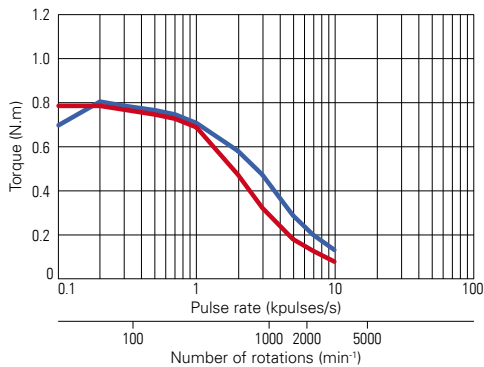

#### 2H5676B20

Driver: BS1D200P10  
Power supply: — 36VDC — 24VDC  
Current: 2A/phase bipolar  
Excitation mode: Full-step  
Load inertia JL = 2.6x10<sup>-4</sup>kg.m<sup>2</sup> (rubber coupling)

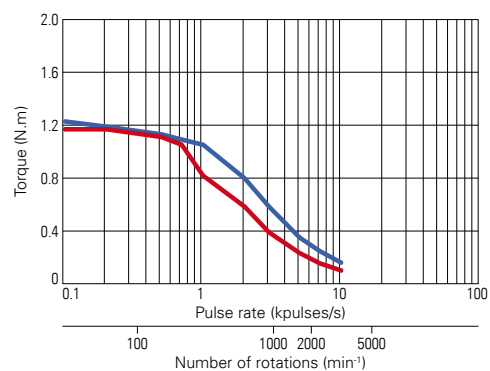

35mm sq.

42mm sq.

56mm sq.

60mm sq.

86mm sq.

Encoder Specifications

Customization Service

## 2H5695B20

Driver: Internal circuit  
 Power supply: — 36V — 24V  
 Current: 2A/phase bipolar  
 Excitation mode: Full-step  
 Load inertia  $J_L = 7.4 \times 10^{-4} \text{ kg.m}^2$  (rubber coupling)

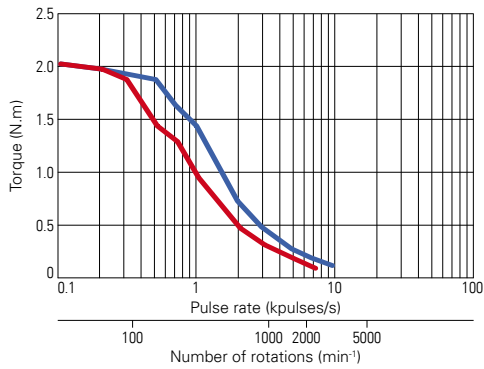

## Dimensions [Unit: mm]

### 2H5654xxxR220

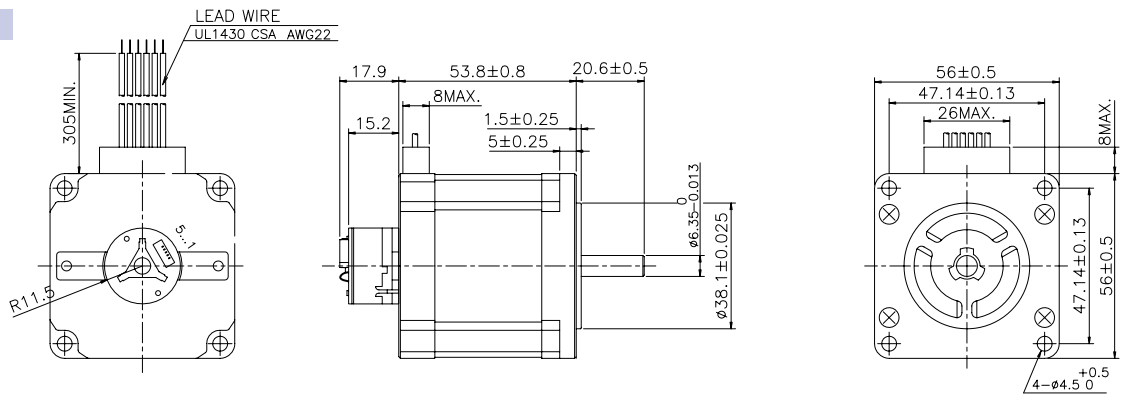

### 2H5695B20R220

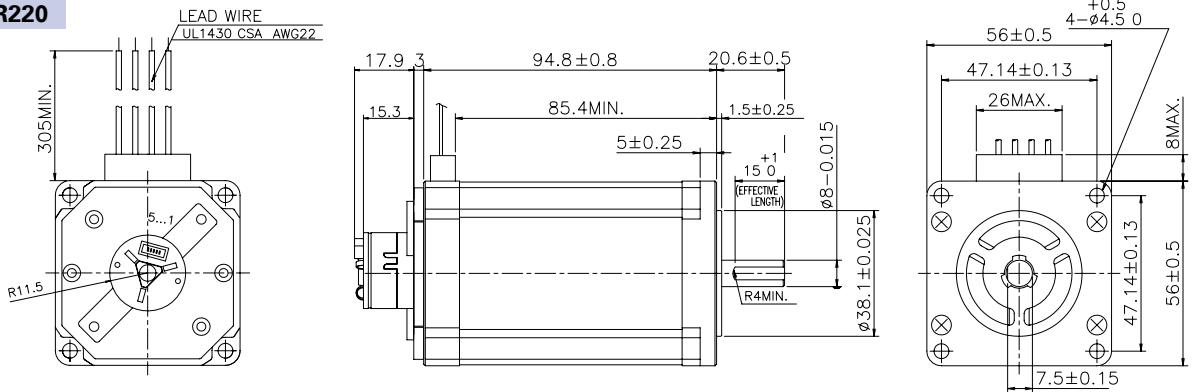

### 2H56xxxxSx40 2H56xxxxM21x

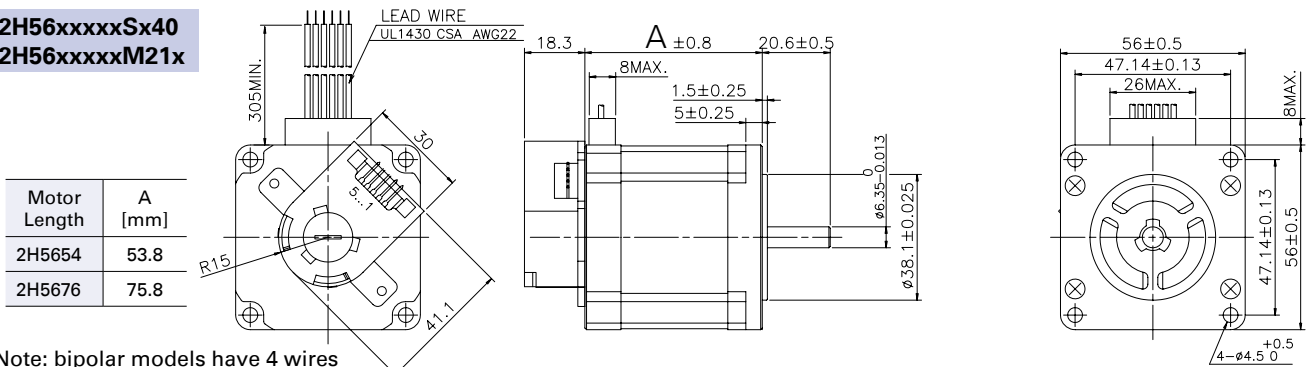

Note: bipolar models have 4 wires

**2H5695B20Sx40**  
**2H5695B20M21x**

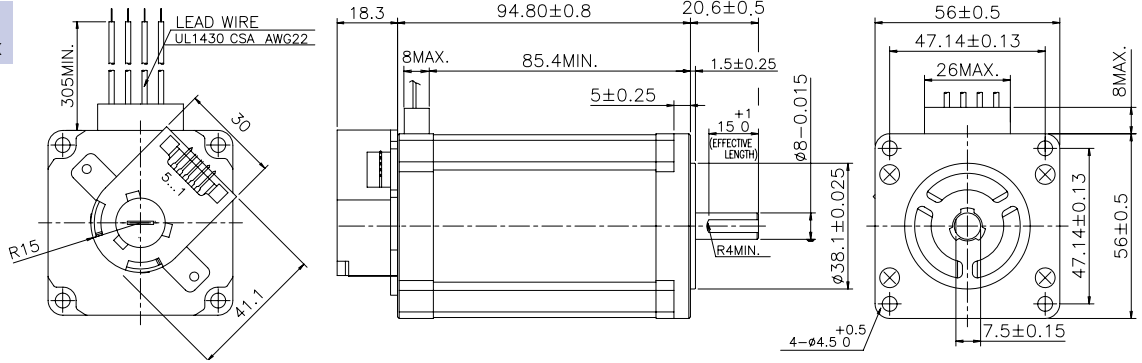

**2H56xxxxxL240**

| Motor Length | A [mm] |
|--------------|--------|
| 2H5654       | 53.8   |
| 2H5676       | 75.8   |

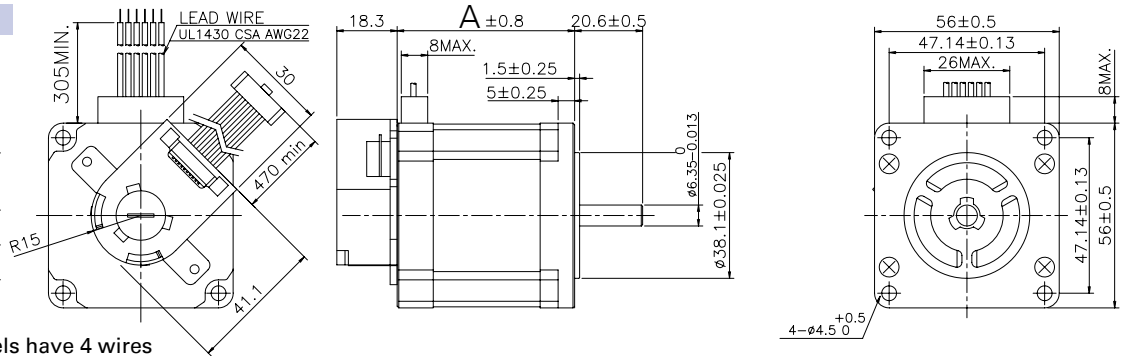

Note: bipolar models have 4 wires

**2H5695B20L240**

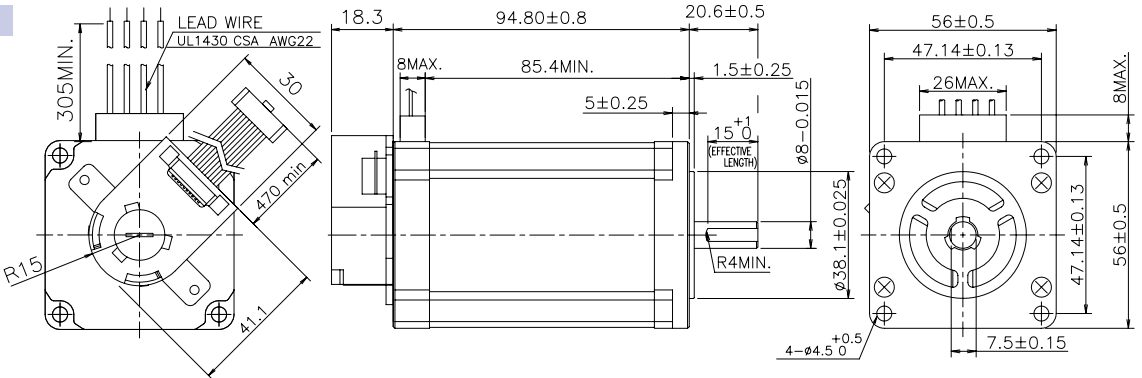

**Internal wiring**

Unipolar winding

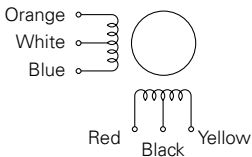

Bipolar winding

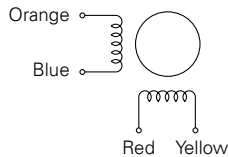

General Specification ▶ p. 24  
Rotation Direction ▶ p. 25

**Encoder cables**

R220 Encoder, Cable P/N: CRS22500

Manufacturer: MOLEX  
Housing: 51021-0500  
Terminal: 50079-8000 or 8100

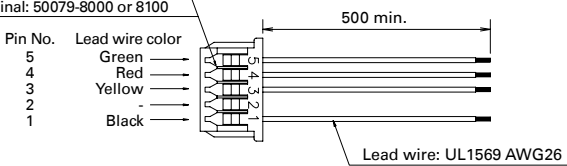

S340 Encoder, Cable P/N: CS3500

Manufacturer: MOLEX  
Housing: 22-01-2055  
(locking ramp cut)

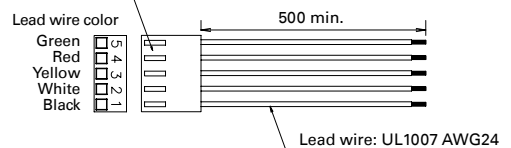

S240, M21x Encoder, Cable P/N: CS2500

Manufacturer: MOLEX  
Housing: 22-01-2055  
(locking ramp cut)

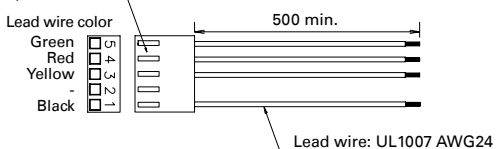

35mm sq.

42mm sq.

56mm sq.

60mm sq.

86mm sq.

Encoder Specifications

Customization Service

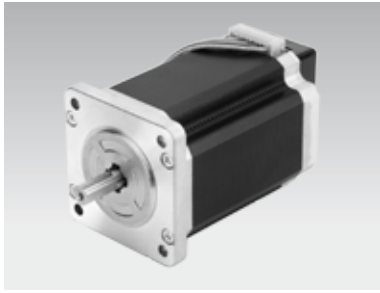

## 60 mm sq.

1.8° /step RoHS

Bipolar winding  
Lead wire type

| Based motor      | Holding torque at 2-phase energization [N.m min.] | Step angle ° | Winding type | Rated current | Wiring resistance | Winding inductance | Rotor Inertia                           | Weight | Optional motor cable |
|------------------|---|--------------|--------------|---------------|-------------------|--------------------|---|--------|----------------------|
|                  |   |              |              | A/phase       | Ω /phase          | mH/phase           | [x 10 <sup>-4</sup> kg.m <sup>2</sup> ] | kg     |                      |
| <b>2H6043B20</b> | 0.88  | 1.8          | Bipolar      | 2             | 1.27              | 3.3                | 0.275                                   | 0.6    | -                    |
| <b>2H6052B20</b> | 1.37  | 1.8          | Bipolar      | 2             | 1.55              | 5.5                | 0.4                                     | 0.77   | -                    |
| <b>2H6084B20</b> | 2.7   | 1.8          | Bipolar      | 2             | 2.4               | 9.5                | 0.84                                    | 1.34   | -                    |

### Dynamic performances

#### 2H6043B20

Driver: BS1D200P10  
Power supply: — 36V — 24V  
Current: 2A/phase bipolar  
Excitation mode: Full-step  
Load inertia JL = 7.4x10<sup>-4</sup>kg.m<sup>2</sup> (rubber coupling)

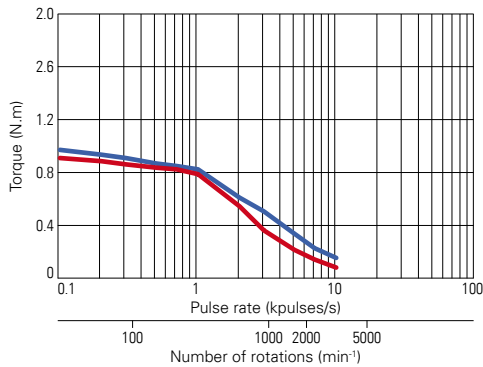

#### 2H6052B20

Driver: BS1D200P10  
Power supply: — 36V — 24V  
Current: 2A/phase bipolar  
Excitation mode: Full-step  
Load inertia JL = 7.4x10<sup>-4</sup>kg.m<sup>2</sup> (rubber coupling)

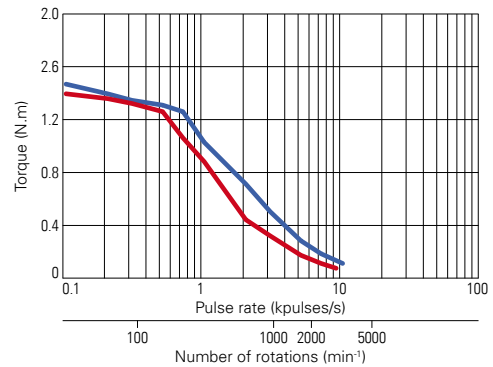

#### 2H6084B20

Driver: BS1D200P10  
Power supply: — 36V — 24V  
Current: 2A/phase bipolar  
Excitation mode: Full-step  
Load inertia JL = 7.4x10<sup>-4</sup>kg.m<sup>2</sup> (rubber coupling)

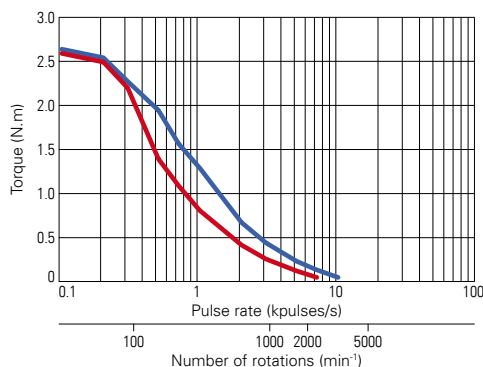



## Dimensions [Unit: mm]

### 2H60xxB20R220

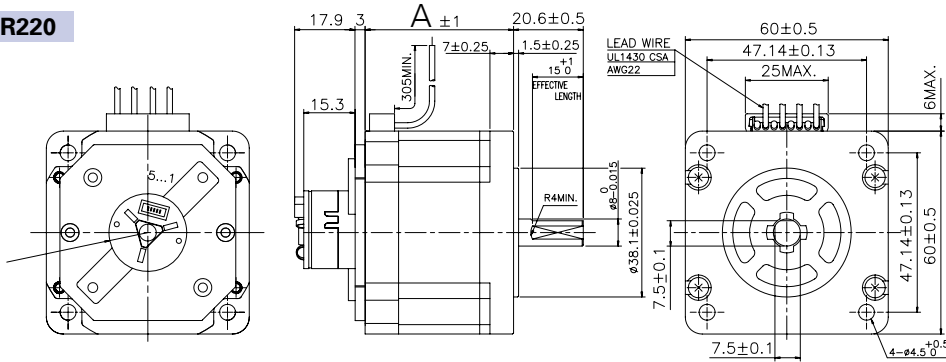

| Motor Length | A [mm] |
|--------------|--------|
| 2H6043       | 43.5   |
| 2H6052       | 52.5   |
| 2H6084       | 84.5   |

### 2H60xxB20Sx40 2H60xxB20M21x

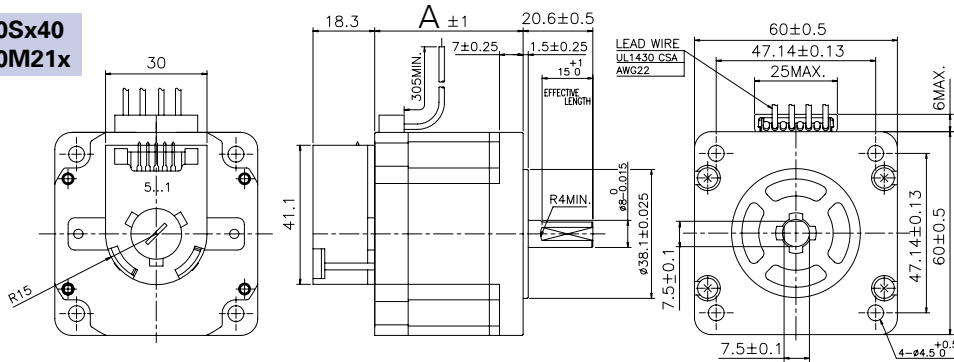

| Motor Length | A [mm] |
|--------------|--------|
| 2H6043       | 43.5   |
| 2H6052       | 52.5   |
| 2H6084       | 84.5   |

### 2H60xxB20L240

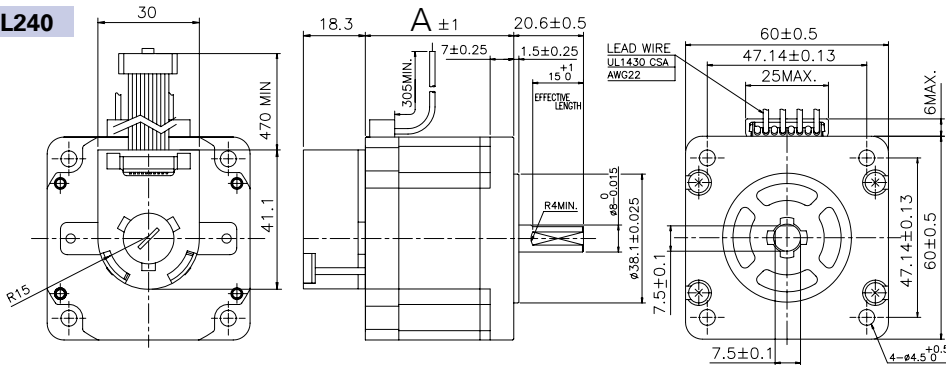

| Motor Length | A [mm] |
|--------------|--------|
| 2H6043       | 43.5   |
| 2H6052       | 52.5   |
| 2H6084       | 84.5   |

## Internal wiring

### Bipolar winding

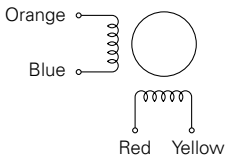

General Specification ▶ p. 24  
Rotation Direction ▶ p. 25

## Encoder cables

### R220 Encoder, Cable P/N: CRS22500

Manufacturer: MOLEX  
Housing: 51021-0500  
Terminal: 50079-8000 or 8100

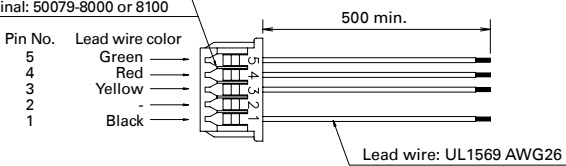

### S340 Encoder, Cable P/N: CS3500

Manufacturer: MOLEX  
Housing: 22-01-2055  
(locking ramp cut)

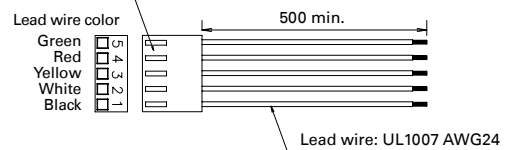

### S240, M21x Encoder, Cable P/N: CS2500

Manufacturer: MOLEX  
Housing: 22-01-2055  
(locking ramp cut)

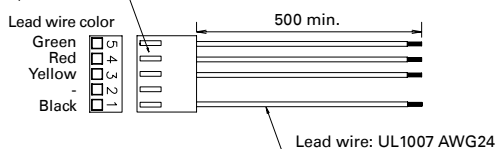

35mm sq.

42mm sq.

56mm sq.

60mm sq.

86mm sq.

Encoder Specifications

Customization Service



# 86 mm sq.

1.8° /step RoHS

Bipolar winding  
Lead wire type

| Based motor       | Holding torque at 2-phase energization | Step angle ° | Winding type | Rated current A/phase | Wiring resistance Ω /phase | Winding inductance mH/phase | Rotor Inertia [x 10 <sup>-4</sup> kg.m <sup>2</sup> ] | Weight kg | Optional motor cable |
|-------------------|--|--------------|--------------|-----------------------|----------------------------|-----------------------------|---|-----------|----------------------|
|                   | [N.m min.]                             |              |              |                       |                            |                             |   |           |                      |
| <b>2H8666B60</b>  | 3.3                                    | 1.8          | Bipolar      | 6                     | 0.29                       | 1.7                         | 1.48  | 1.75      | -                    |
| <b>2H8696B60</b>  | 6.4                                    | 1.8          | Bipolar      | 6                     | 0.36                       | 2.8                         | 3   | 2.9       | -                    |
| <b>2H86127B60</b> | 9.0                                    | 1.8          | Bipolar      | 6                     | 0.46                       | 3.8                         | 4.5   | 4.0       | -                    |

## Dynamic performances

### 2H8666B60

Driver: Internal circuit  
Power supply: 100VAC  
Current: 6A/phase bipolar  
Excitation mode: Full-step  
Load inertia JL = 15.3x10<sup>-4</sup>kg.m<sup>2</sup> (rubber coupling)

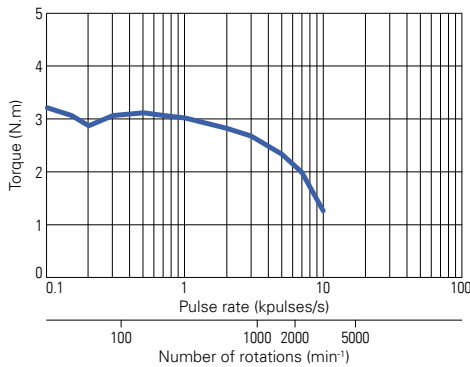

### 2H8696B60

Driver: Internal circuit  
Power supply: 100VAC  
Current: 6A/phase bipolar  
Excitation mode: Full-step  
Load inertia JL = 15.3x10<sup>-4</sup>kg.m<sup>2</sup> (rubber coupling)

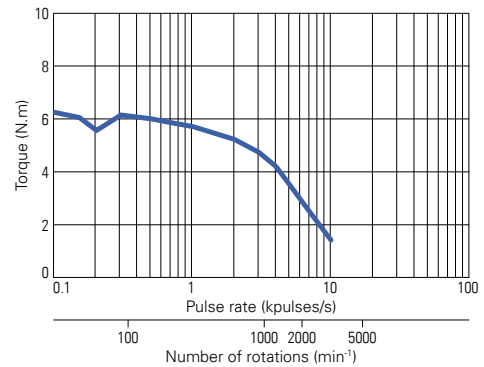

### 2H86127B60

Driver: Internal circuit  
Power supply: 100VAC  
Current: 6A/phase bipolar  
Excitation mode: Full-step  
Load inertia JL = 44x10<sup>-4</sup>Kg.m<sup>2</sup> (rubber coupling)

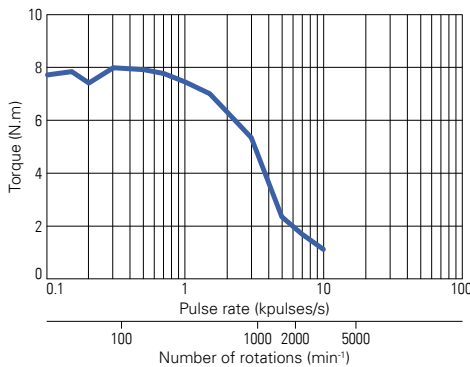

## Dimensions [Unit: mm]

### 2H86xxB60R220 2H86xxxB60R220

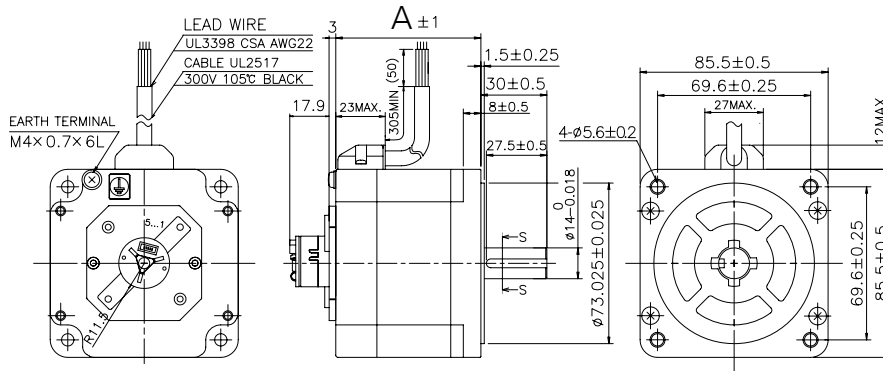

| Motor Length | A [mm] |
|--------------|--------|
| 2H8666       | 66     |
| 2H8696       | 96.5   |
| 2H86127      | 127    |

### 2H86xxB60Sx40 2H86xxxB60Sx40

### 2H86xxB60M21x 2H86xxxB60M21x

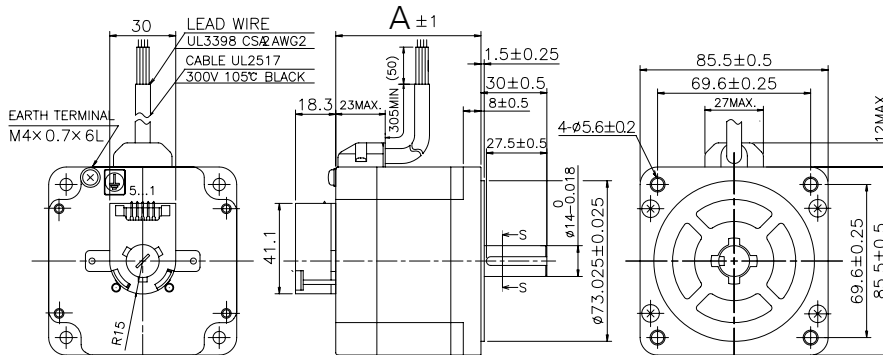

| Motor Length | A [mm] |
|--------------|--------|
| 2H8666       | 66     |
| 2H8696       | 96.5   |
| 2H86127      | 127    |

### 2H86xxB60L240 2H86xxxB60L240

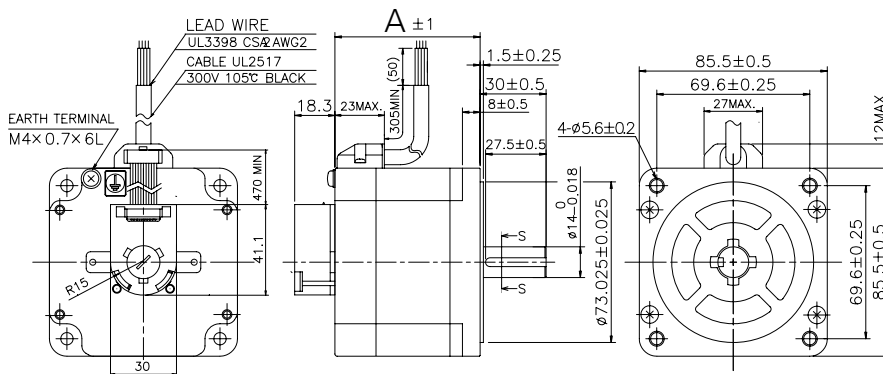

| Motor Length | A [mm] |
|--------------|--------|
| 2H8666       | 66     |
| 2H8696       | 96.5   |
| 2H86127      | 127    |

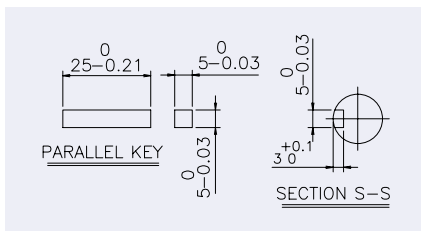

## Internal wiring

### Bipolar winding

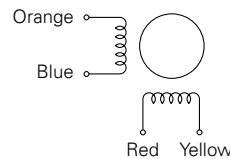

General Specification ▶ p. 24  
Rotation Direction ▶ p. 25

## Encoder cables

### R220 Encoder, Cable P/N: CRS22500

Manufacturer: MOLEX  
Housing: 51021-0500  
Terminal: 50079-8000 or 8100

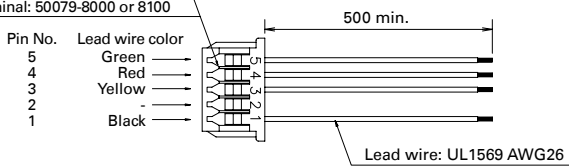

### S340 Encoder, Cable P/N: CS3500

Manufacturer: MOLEX  
Housing: 22-01-2055  
(locking ramp cut)

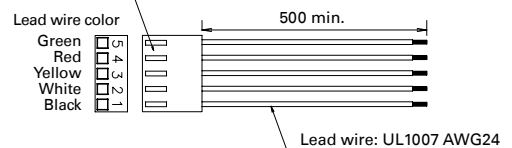

### S240, M21x Encoder, Cable P/N: CS2500

Manufacturer: MOLEX  
Housing: 22-01-2055  
(locking ramp cut)

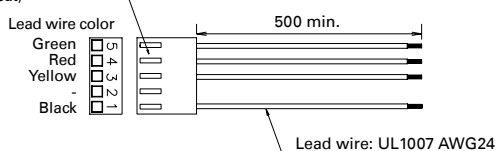

35mm sq.

42mm sq.

56mm sq.

60mm sq.

86mm sq.

Encoder Specifications

Customization Service



# R type Encoder

RoHS

- Two channel quadrature outputs
- Resolution 200 counts per revolution
- TTL compatible
- Single 5VDC supply
- HEDR serie encoders from Broadcom Limited

## Encoder features

| Parameter                | R220                         |
|--------------------------|------------------------------|
| Supply voltage [VDC]     | 5 ± 0.5                      |
| Max. Supply current [mA] | 33                           |
| Output voltage [VDC]     | VOH = 2.4 min, VOL = 0.4 max |
| Output channels          | 2 (A, B)                     |
| Maximum frequency [kHz]  | 16                           |

## Encoder pin-outs

| Pins  | R220         | R220         |
|-------|--------------|--------------|
|       | 35, 42mm sq. | 56, 86mm sq. |
| Pin 1 | Channel B    | GND          |
| Pin 2 | 5 VDC        | NC           |
| Pin 3 | Channel A    | Channel A    |
| Pin 4 | NC           | 5 VDC        |
| Pin 5 | GND          | Channel B    |

## Encoder P/N

R220: 2 channels, 200CPR

## Output waveforms

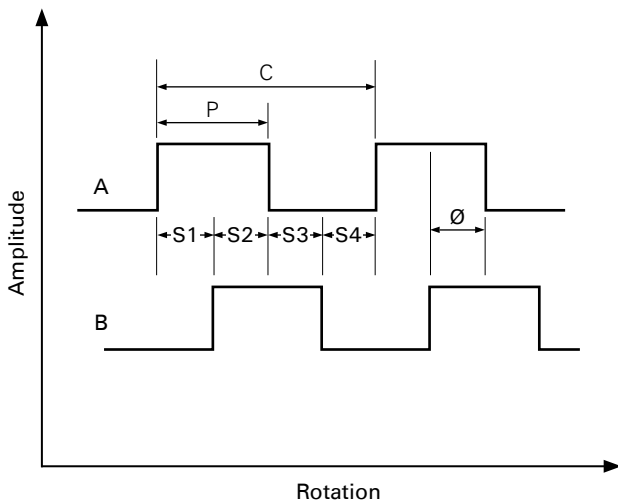

## Encoding characteristics

| Parameter                | Symbol             | R220  |      |
|--------------------------|--------------------|-------|------|
|                          |                    | Typ.* | Max. |
| Pulse width error [°e]   | $\Delta P$         | 7     | 75   |
| Logic width error [°e]   | $\Delta S$         | 15    | 60   |
| Phase error [°e]         | $\Delta \emptyset$ | 15    | 60   |
| Position error [arcmin.] | $\Delta \Theta$    | 50    | 120  |
| Cycle error [°e]         | $\Delta C$         | 10    | 45   |

\*Typical values specified at supply voltage = 5.0 V and 25°C

## Electrical interface

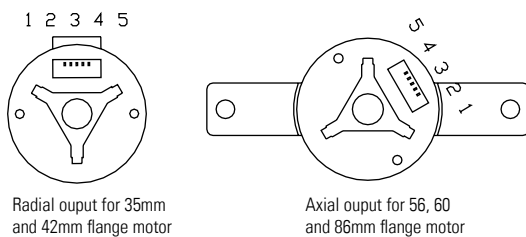

Radial output for 35mm and 42mm flange motor

Axial output for 56, 60 and 86mm flange motor

Pull-up resistors on output pins have already been integrated. Each of the three encoder outputs can drive a single TTL load in this configuration.

## Suitable connectors

| Manufacturer | Part number |            |
|--------------|-------------|------------|
|              | Housing     | Contact    |
| Molex        | 51021-0500  | 50079-8000 |

## Encoder cables

R220 Encoder, 35 & 42mm flange Motor, Cable P/N: CRP12500

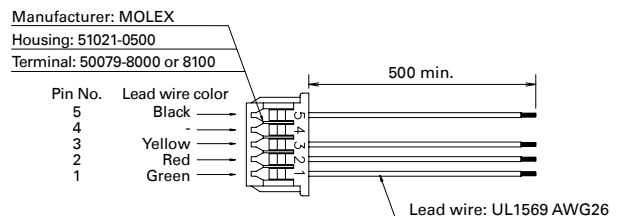

R220 Encoder, 56, 60 & 86mm flange Motor, Cable P/N: CRS22500

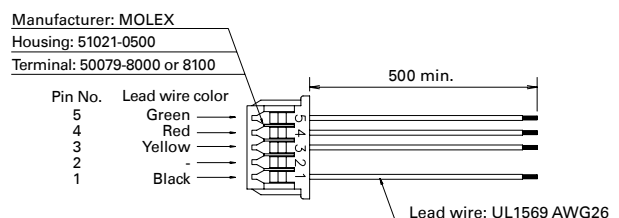



# S type Encoder

RoHS

- Two channel quadrature outputs with optional index pulse
- Resolution 400 or 500 counts per revolution
- Single ended output signals, TTL compatible
- Single 5VDC supply
- HEDS serie encoders from Broadcom Limited

## Encoder features

| Parameter                | S240                         | S340        |
|--------------------------|------------------------------|-------------|
| Supply voltage [VDC]     | 5 ± 0.5                      |             |
| Max. Supply current [mA] | 40                           | 85          |
| Output voltage [VDC]     | VOH = 2.4 min, VOL = 0.4 max |             |
| Output channels          | 2 (A, B)                     | 3 (A, B, I) |
| Maximum frequency [kHz]  | 100                          |             |

## Encoder pin-outs

| Pins  | S240      | S340      |
|-------|-----------|-----------|
| Pin 1 | GND       |           |
| Pin 2 | NC        | Channel I |
| Pin 3 | Channel A |           |
| Pin 4 | 5 VDC     |           |
| Pin 5 | Channel B |           |

## Encoder P/N

**S240:** 2 channels, 400CPR  
**S340:** 3 channels, 400CPR

## Output waveforms

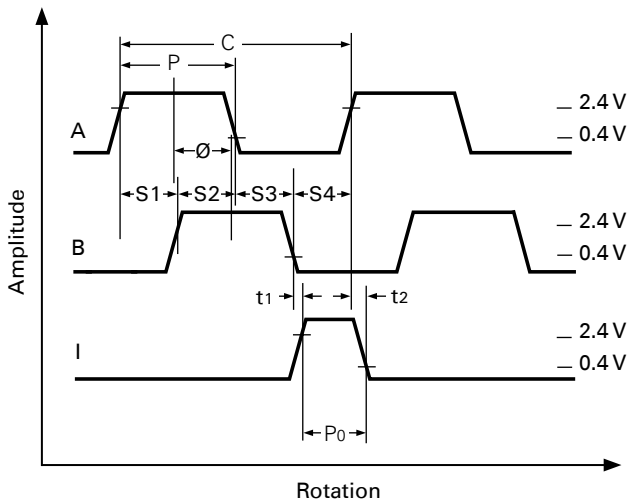

## Encoding characteristics

| Parameter                              | Symbol          | S240 |       |      | S340 |       |      |
|--|-----------------|------|-------|------|------|-------|------|
|  |                 | Min. | Typ.* | Max. | Min. | Typ.* | Max. |
| Pulse width error [°e]                 | $\Delta P$      |      | 7     | 45   | 5    | 45    |      |
| Logic width error [°e]                 | $\Delta S$      |      | 5     | 45   | 5    | 35    |      |
| Phase error [°e]                       | $\Delta \theta$ |      | 2     | 20   | 2    | 15    |      |
| Position error [arcmin.]               | $\Delta \theta$ |      | 10    | 40   | 10   | 40    |      |
| Cycle error [°e]                       | $\Delta C$      |      | 3     | 5.5  | 3    | 5.5   |      |
| Index pulse width [°e]                 | $P_0$           |      |       |      | 55   | 90    | 125  |
| CH.I rise after CH.A or CH.B fall [ns] | $t_1$           |      |       |      | -300 | 100   | 250  |
| CH.I fall after CH.A or CH.B rise [ns] | $t_2$           |      |       |      | 70   | 150   | 1000 |

\*Typical values specified at supply voltage = 5.0 VDC and 25°C

## Electrical interface

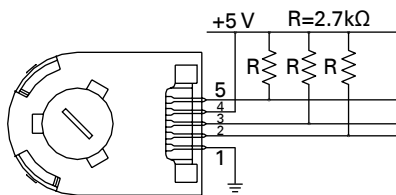

S340 encoders require 2.7kΩ (±10%) pull-up resistors on output pins 2,3 and 5 (Channels I, A and B). These pull-up resistors should be located as close to the encoder as possible.

S240 encoders do not normally require pull-up resistors. However, 3.2kΩ pull-up resistors on output pins 3 and 5 (Channels A and B) are recommended.

## Suitable connectors

| Manufacturer | Part number |             |
|--------------|-------------|-------------|
|              | Housing     | Contact     |
| AMP          | 103686-4    | 640442-5    |
| Molex        | 2695 series | 2759 series |
| FCI          | 65039-032   | 4825X-000   |

## Encoder cables

S240 Encoder, Cable P/N: CS2500

Manufacturer: MOLEX  
 Housing: 22-01-2055  
 (locking ramp cut)

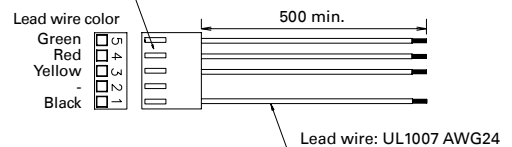

S340 Encoder, Cable P/N: CS3500

Manufacturer: MOLEX  
 Housing: 22-01-2055  
 (locking ramp cut)

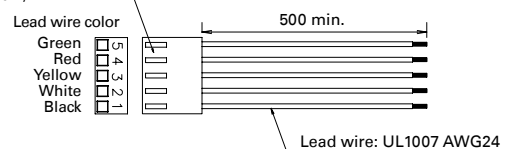

35mm sq.

42mm sq.

56mm sq.

60mm sq.

86mm sq.

Encoder Specifications

Customization Service



# M type Encoder RoHS

- Two channel quadrature outputs with optional index pulse
- Resolution 1000 or 1024 counts per revolution
- Single ended output signals, TTL compatible
- Single 5VDC supply
- HEDM serie encoders from Broadcom Limited

## Encoder features

| Parameter                | M21x                         | M310        |
|--------------------------|------------------------------|-------------|
| Supply voltage [VDC]     | 5 ± 0.5                      |             |
| Max. Supply current [mA] | 85                           |             |
| Output voltage [VDC]     | VOH = 2.4 min, VOL = 0.4 max |             |
| Output channels          | 2 (A, B)                     | 3 (A, B, I) |
| Maximum frequency [kHz]  | 100                          |             |

## Encoder pin-outs

| Pins  | M21x      | M310      |
|-------|-----------|-----------|
| Pin 1 | GND       |           |
| Pin 2 | NC        | Channel I |
| Pin 3 | Channel A |           |
| Pin 4 | 5 VDC     |           |
| Pin 5 | Channel B |           |

## Encoder P/N

**M210:** 2 channels, 1000CPR  
**M211:** 2 channels, 1024CPR  
**M310:** 3 channels, 1000CPR

## Output waveforms

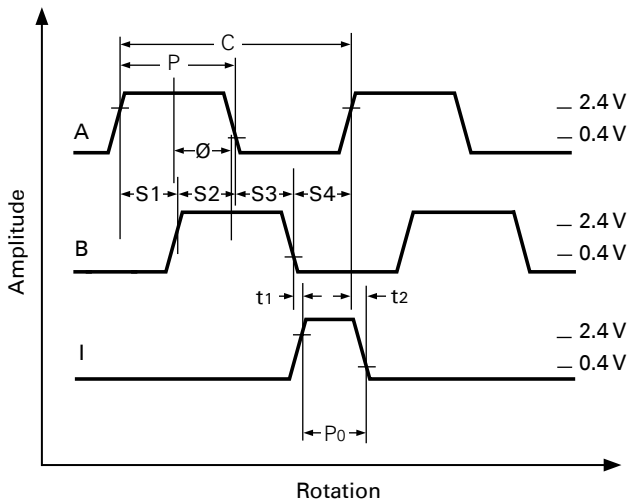

## Encoding characteristics

| Parameter                              | Symbol | M21x |       |      | M310 |       |      |
|--|--------|------|-------|------|------|-------|------|
|  |        | Min. | Typ.* | Max. | Min. | Typ.* | Max. |
| Pulse width error [°e]                 | ΔP     | 10   | 45    | 5    | 45   |       |      |
| Logic width error [°e]                 | ΔS     | 10   | 45    | 5    | 35   |       |      |
| Phase error [°e]                       | Δ∅     | 2    | 15    | 2    | 15   |       |      |
| Position error [arcmin.]               | Δ∅     | 10   | 40    | 10   | 40   |       |      |
| Cycle error [°e]                       | ΔC     | 3    | 7.5   | 6    | 12   |       |      |
| Index pulse width [°e]                 | P0     |      |       | 50   | 90   | 130   |      |
| CH.I rise after CH.A or CH.B fall [ns] | t1     |      |       | 200  | 1000 | 1500  |      |
| CH.I fall after CH.A or CH.B rise [ns] | t2     |      |       | 0    | 300  | 1500  |      |

\*Typical values specified at supply voltage = 5.0 VDC and 25°C

## Electrical interface

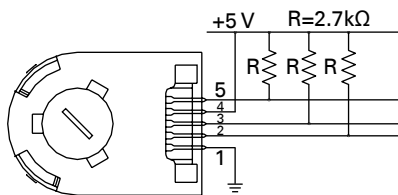

M310 encoder requires 2.7kΩ (±10%) pull-up resistors on output pins 2,3 and 5 (Channels I, A and B). These pull-up resistors should be located as close to the encoder as possible.

M21x encoders do not normally require pull-up resistors. However, 3.2kΩ pull-up resistors on output pins 3 and 5 (Channels A and B) are recommended.

## Suitable connectors

| Manufacturer | Part number |             |
|--------------|-------------|-------------|
|              | Housing     | Contact     |
| AMP          | 103686-4    | 640442-5    |
| Molex        | 2695 series | 2759 series |
| FCI          | 65039-032   | 4825X-000   |

## Encoder cables

M21x Encoder, Cable P/N: CS2500

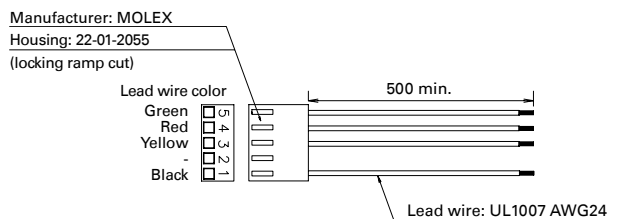

M310 Encoder, Cable P/N: CS3500

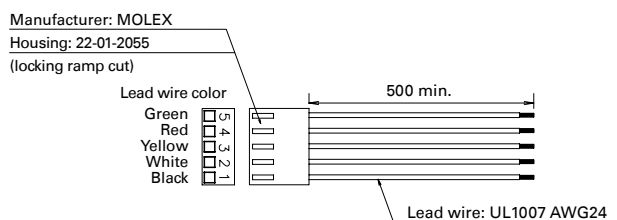

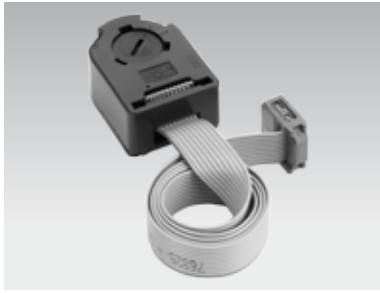

# L type Encoder

RoHS

- Two channel quadrature complementary outputs
- Resolution 400 counts per revolution
- Industry standard Line Driver IC
- Single 5VDC supply
- HEDL serie encoders from Broadcom Limited

## Encoder features

| Parameter                | L240                         |
|--------------------------|------------------------------|
| Supply voltage [VDC]     | 5 ± 0.5                      |
| Max. Supply current [mA] | 40                           |
| Output voltage [VDC]     | VOH = 2.4 min, VOL = 0.4 max |
| Output channels          | 2 (A, B)                     |
| Maximum frequency [kHz]  | 100                          |
| Line driver IC *         | AM26C31Q                     |

\* Suggested line receivers are 26LS32 and 26LS33

## Encoder P/N

L240: 2 channels, 400CPR

## Output waveforms

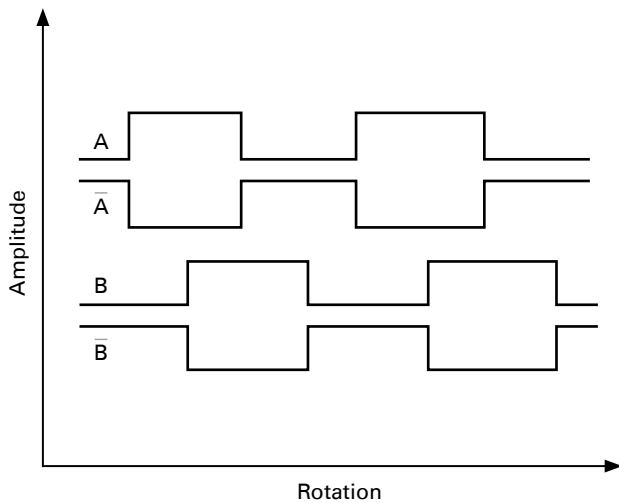

For additional information, please refer to S240 specifications.

## Encoder pin-outs

| Pins  |      | L240   |    |
|-------|------|--------|----|
| Pin 1 | NC   | Pin 6  | A  |
| Pin 2 | 5VDC | Pin 7  | /B |
| Pin 3 | GND  | Pin 8  | B  |
| Pin 4 | NC   | Pin 9  | NC |
| Pin 5 | /A   | Pin 10 | NC |

10 Position connector center polarized BERG HE10

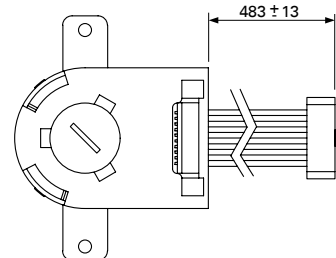
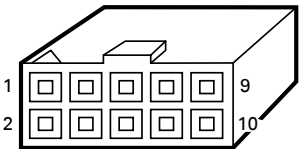

35mm sq.

42mm sq.

56mm sq.

60mm sq.

86mm sq.

Encoder Specifications

Customization Service

# General Specifications

| Model number                                      | 2H35 □  | 2P42 □   | 2H42 □  | 2H56 □    | 2H60 □  | 2H86 □   |
|---|---|----------|---|-----------|---|--|
| Type  | -   |          |   |           |   | S1 (continuous operation)  |
| Operating ambient temperature                     | -10°C to +50°C  |          |   |           |   | -10°C to +40°C   |
| Storage temperature                               | -20°C to +65°C  |          |   |           |   | -20°C to +60°C   |
| Operating ambient humidity                        | 20 to 90% RH (no condensation)  |          |   |           |   | 95% max: 40°C max<br>57% max: 50°C max<br>35% max: 60°C max<br>(no condensation) |
| Storage humidity                                  | 5 to 95% RH (no condensation)   |          |   |           |   |  |
| Operation altitude                                | 1000 m max. above sea level   |          |   |           |   |  |
| Vibration resistance                              | Vibration frequency 10 to 500Hz, total amplitude 1.52 mm (10 to 70 Hz), vibration acceleration 150 m/s <sup>2</sup> (70 to 500 Hz), sweep time 15min/cycle, 12 sweeps in each X, Y and Z directions |          |   |           |   |  |
| Impact resistance                                 | 500 m/s <sup>2</sup> of acceleration for 11 ms with half-sine wave applying three times for X, Y and Z axes each, 18 times in total   |          |   |           |   |  |
| Insulation class                                  | Class B (+130°C)  |          |   |           |   | Class F (+155°C)   |
| Withstandable voltage                             | At normal temperature and humidity, no failure with 500 VAC @50/60 Hz applied for one minute between motor winding and frame  |          | At normal temperature and humidity, no failure with 1000 VAC @50/60 Hz applied for one minute between motor winding and frame |           | At normal temperature and humidity, no failure with 1500 VAC @50/60 Hz applied for one minute between motor winding and frame |  |
| Insulation resistance                             | At normal temperature and humidity, not less than 100 mΩ between winding and frame by 500 VDC megger  |          |   |           |   |  |
| Protection grade                                  | IP40  |          |   |           |   | IP43   |
| Winding temperature rise                          | 80 K max. (based on Sanyo Denki standard)   |          |   |           |   |  |
| Static angle error                                | ± 0.09°   |          | ± 0.054°  |           | ± 0.09°   |  |
| Thrust play (1)                                   | 0.075 mm max. (load: 5 N)   |          | 0.075 mm max. (load: 10 N)  |           |   |  |
| Radial play (2)                                   | 0.025 mm max. (load: 5 N)   |          |   |           |   |  |
| Shaft run outs                                    | 0.025mm   |          |   |           |   |  |
| Concentricity of mounting pilot relative to shaft | ∅ 0.075mm   | ∅ 0.05mm |   | ∅ 0.075mm |   |  |
| Squareness of mounting surface relative to shaft  | 0.1mm   |          | 0.075mm   |           | 0.15mm  |  |
| Direction of motor mounting                       | Can be freely mounted vertically or horizontally  |          |   |           |   |  |

1) Thrust play: shaft displacement under axial load

2) Radial play: shaft displacement under radial load applied 1/3rd of the length from the end of the shaft



# Internal Wiring and Rotation Direction

## Unipolar winding

Connector type

### Internal wire connection

( ) connector pin number

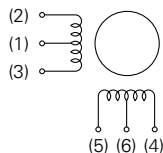

### Direction of motor rotation

When excited by a direct current in the order shown below, the direction of rotation is clockwise as viewed from the output shaft side.

|                |   | Connector pin number |     |     |     |     |
|----------------|---|----------------------|-----|-----|-----|-----|
|                |   | (1.6)                | (5) | (3) | (4) | (2) |
| Exciting order | 1 | +                    | -   | -   | -   | -   |
|                | 2 | +                    | -   | -   | -   | -   |
|                | 3 | +                    | -   | -   | -   | -   |
|                | 4 | +                    | -   | -   | -   | -   |

Lead wire type

### Internal wire connection

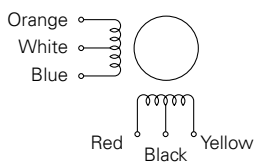

### Direction of motor rotation

When excited by a direct current in the order shown below, the direction of rotation is clockwise as viewed from the output shaft side.

|                |   | Lead wire color |     |      |        |        |
|----------------|---|-----------------|-----|------|--------|--------|
|                |   | White & black   | Red | Blue | Yellow | Orange |
| Exciting order | 1 | +               | -   | -    | -      | -      |
|                | 2 | +               | -   | -    | -      | -      |
|                | 3 | +               | -   | -    | -      | -      |
|                | 4 | +               | -   | -    | -      | -      |

## Bipolar winding

Connector type

### Internal wire connection

( ) connector pin number, terminal block number

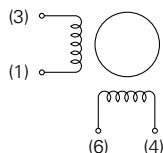

### Direction of motor rotation

When excited by a direct current in the order shown below, the direction of rotation is clockwise as viewed from the output shaft side.

|                |   | Connector pin number, terminal block number |     |     |     |
|----------------|---|---|-----|-----|-----|
|                |   | (6)   | (1) | (4) | (3) |
| Exciting order | 1 | -   | -   | +   | +   |
|                | 2 | +   | -   | -   | +   |
|                | 3 | +   | +   | -   | -   |
|                | 4 | -   | +   | +   | -   |

Lead wire type

### Internal wire connection

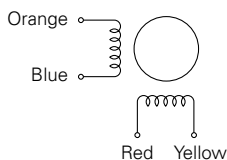

### Direction of motor rotation

When excited by a direct current in the order shown below, the direction of rotation is clockwise as viewed from the output shaft side.

|                |   | Lead wire color |      |        |        |
|----------------|---|-----------------|------|--------|--------|
|                |   | Red             | Blue | Yellow | Orange |
| Exciting order | 1 | -               | -    | +      | +      |
|                | 2 | +               | -    | -      | +      |
|                | 3 | +               | +    | -      | -      |
|                | 4 | -               | +    | +      | -      |

35mm sq.

42mm sq.

56mm sq.

60mm sq.

86mm sq.

Encoder Specifications

Customization Service



## Quick Customization Service

Have you ever struggled to meet a particular need using off-the-shelf stepping motor only to realize that you effectively have no solution space? If so, you have a valuable partner in SANYO DENKI EUROPE.

In addition to standard models of stepping motors with encoders, we specialize in designing and building custom solutions that meet the precise needs of our customers.

### Easy customization

With our extensive experience in designing and manufacturing custom stepping motors with encoder systems, our stepping motors can be easily customized to mount almost any types of encoders thanks to specific adaption plates.

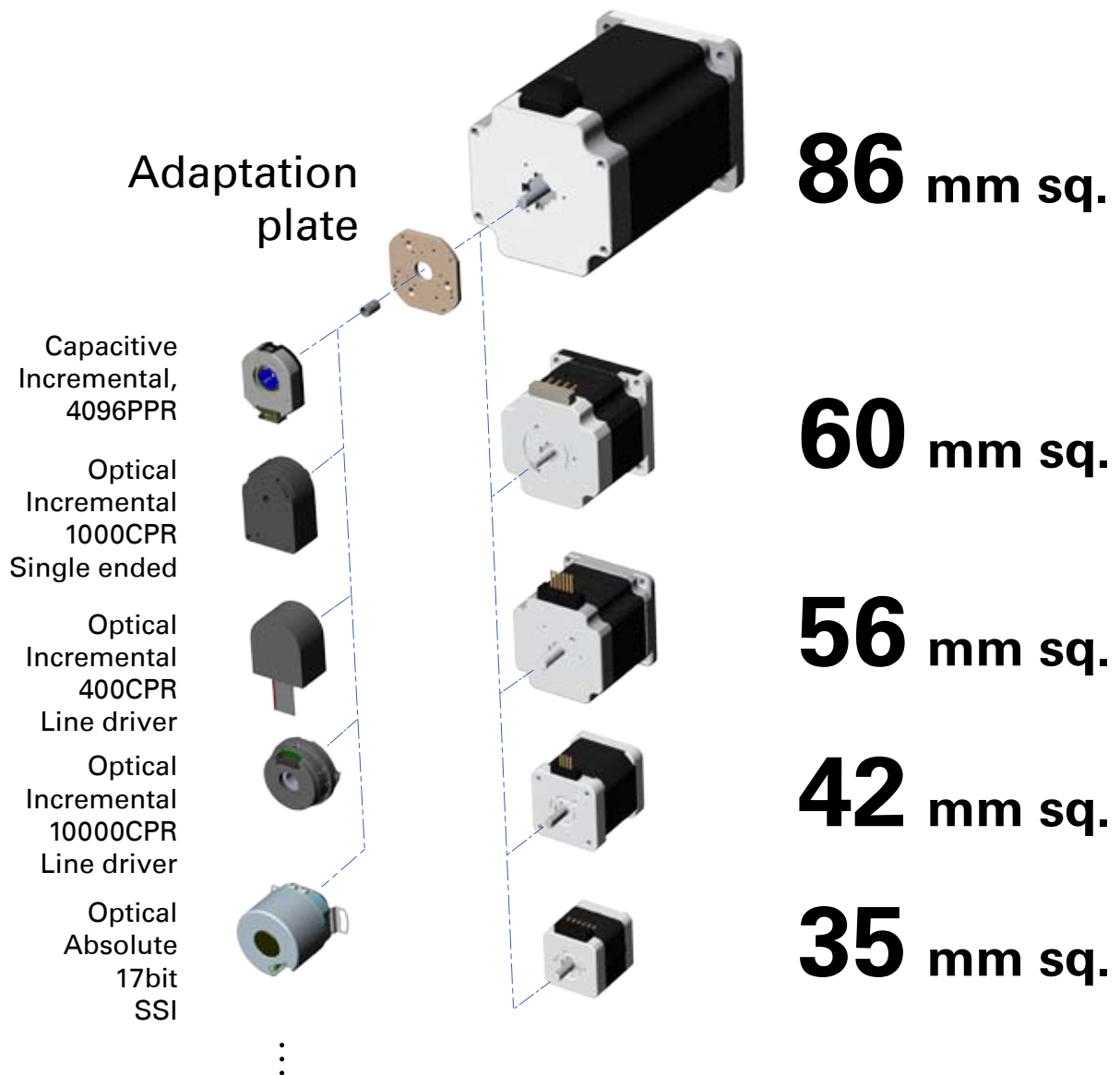

### Quick customization

With in-house CNC machining capabilities at Villepinte (FR) location, we are able to provide samples of customized stepping with encoders at a cost effective price with minimal lead times.

### Customization examples

#### 3D Printing Machine



- 42mm sq. hollowshaft
- Non-captive leadscrew
- PTFE coating
- Anti-backlash nut
- Incremental hollowshaft encoder 400CPR

Easy integration and space saving  
PTFE coating for high efficiency and long life time

#### Medical Instrumentation



- 35mm sq.
- Pinion gears attached
- Customized harness
- Adaptation plate
- Incremental encoder 10.000CPR

Easy integration, quick sample delivery  
Complete solution  
High resolution encoder for accuracy and safety

#### Industrial Application

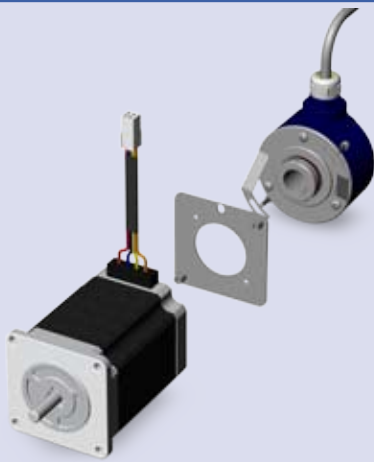

- 56mm sq.
- Customized harness
- Adaptation plate
- Ball bearing encoder
- 12 bit absolute encoder BiSS interface

Ball bearing encoder for robust design  
High resolution absolute encoder for accuracy  
High design flexibility: motors size, encoder protocols

#### Industrial Application



- 56mm sq.
- Customized harness
- Direct mounting
- Ball bearing encoder
- 12 bit absolute encoder SSI interface

Ball bearing encoder for robust design  
High resolution absolute encoder for accuracy  
High design flexibility: motors size, encoder protocols



# MEMO

---

# MEMO

---

# MEMO

---

### ■ Precautions For Adoption

Failure to follow the precautions on the right may cause moderate injury and property damage, or in some circumstances, could lead to a serious accident.

Always follow all listed precautions.



### Cautions

- Read the accompanying Instruction Manual carefully prior to using the product.
- If applying to medical devices and other equipment affecting people's lives, please contact us beforehand and take appropriate safety measures.
- If applying to equipment that can have significant effects on society and the general public, please contact us beforehand.
- Do not use this product in an environment where vibration is present, such as in a moving vehicle or shipping vessel.
- Do not perform any retrofitting, re-engineering or modification to this equipment.
- The products presented in this catalog are meant to be used for general industrial applications. If using for special applications related to aviation and space, nuclear power, electric power, submarine repeaters, etc., please contact us beforehand.

\* For any question or inquiry regarding the above, contact our Sales Department.

---

**SANYO DENKI EUROPE SA.**

P.A. Paris Nord II, 48 Allée des Erables-VILLEPINTE, BP.57286, F-95958 ROISSY CDG Cedex, France

<http://www.sanyodenki.eu>

TEL: + 33 1 48 63 26 61

The names of companies and/or their products specified in this catalog are the trade names, and/or trademarks and/or registered trademarks of such respective companies. Specifications are subject to change without notice.

CATALOG 16.1109