



# MP4315

## 45V, 5A, Low I<sub>Q</sub>, Synchronous Step-Down Converter with Frequency Spread Spectrum and Power Good Indication

### DESCRIPTION

The MP4315 is a synchronous step-down switching converter with a configurable frequency, as well as an integrated internal high-side MOSFET (HS-FET) and low-side MOSFET (LS-FET). The device provides up to 5A of highly efficient output with current mode control for fast loop response.

The wide 3.3V to 45V input voltage range accommodates a variety of step-down applications in automotive input environments. The MP4315's low 1.7 $\mu$ A shutdown mode quiescent current makes the device well-suited for battery-powered applications.

High power conversion efficiency across a wide load range is achieved by scaling down the switching frequency under light-load conditions to reduce the switching and gate driver losses. An open-drain power good signal indicates whether the output is within 93% to 106% of its nominal voltage.

Frequency foldback helps prevent inductor current runaway during start-up. Thermal shutdown provides reliable, fault-tolerant operation. High-duty cycle and low-dropout mode are provided for the automotive cold crank conditions.

The MP4315 is available in a QFN-20 (4mmx4mm) wettable flank package.

### FEATURES

- Wide 3.3V to 45V Operating Voltage Range
- 5A Continuous Output Current
- 1.7 $\mu$ A Low Shutdown Supply Current
- 18 $\mu$ A Sleep Mode Quiescent Current
- Internal 48m $\Omega$  High-Side MOSFET and 20m $\Omega$  Low-Side MOSFET
- 350kHz to 1000kHz Configurable Switching Frequency for Car Battery Applications
- Can Be Synchronized to an External Clock
- Out-of-Phase Synchronized Clock Output
- Frequency Spread Spectrum (FSS) for Low EMI
- Symmetric V<sub>IN</sub> for Low EMI
- Power Good Output
- External Soft Start
- 100ns Minimum On Time
- Selectable Advanced Asynchronous Mode (AAM) or Forced Continuous Conduction Mode (FCCM)
- Low-Dropout Mode
- Hiccup Over-Current Protection
- Available in a QFN-20 (4mmx4mm) Package
- Available in a Wettable Flank Package

### APPLICATIONS

- Radios
- Battery Power Systems
- General Purpose Consumer Applications
- Industrial Power Systems

All MPS parts are lead-free, halogen-free, and adhere to the RoHS directive. For MPS green status, please visit the MPS website under Quality Assurance. "MPS", the MPS logo, and "Simple, Easy Solutions" are trademarks of Monolithic Power Systems, Inc. or its subsidiaries.

## TYPICAL APPLICATION

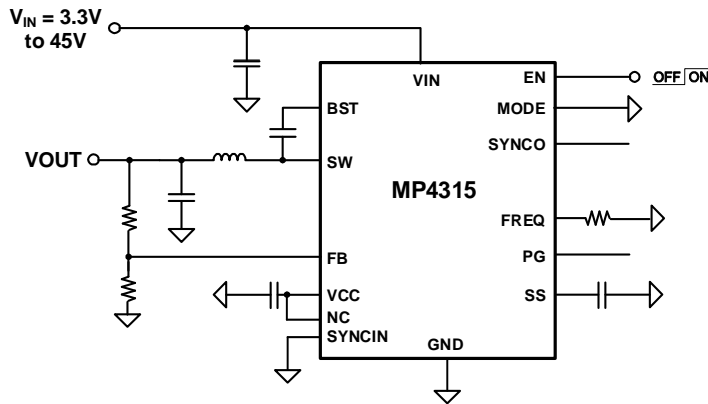

### Efficiency vs. Load Current vs. Power Loss

V<sub>OUT</sub> = 3.3V, f<sub>sw</sub> = 470kHz, L = 4.7μH, AAM

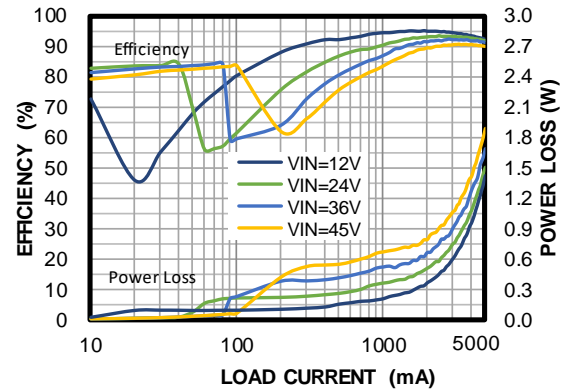

### ORDERING INFORMATION

Part Number*	Package	Top Marking	MSL Rating**
MP4315GRE***	QFN-20 (4mmx4mm)	See Below	1

\* For Tape & Reel, add suffix -Z (e.g. MP4315GRE-Z).

\*\* Moisture Sensitivity Level Rating

\*\*\* Wettable Flank

### TOP MARKING (MP4315GRE)

MPSYWW

**MP4315**

**LLLLLL**

**E**

MPS: MPS prefix  
 Y: Year code  
 WW: Week code  
 MP4315: Part number  
 LLLLLL: Lot number  
 E: Wettable flank

### PACKAGE REFERENCE

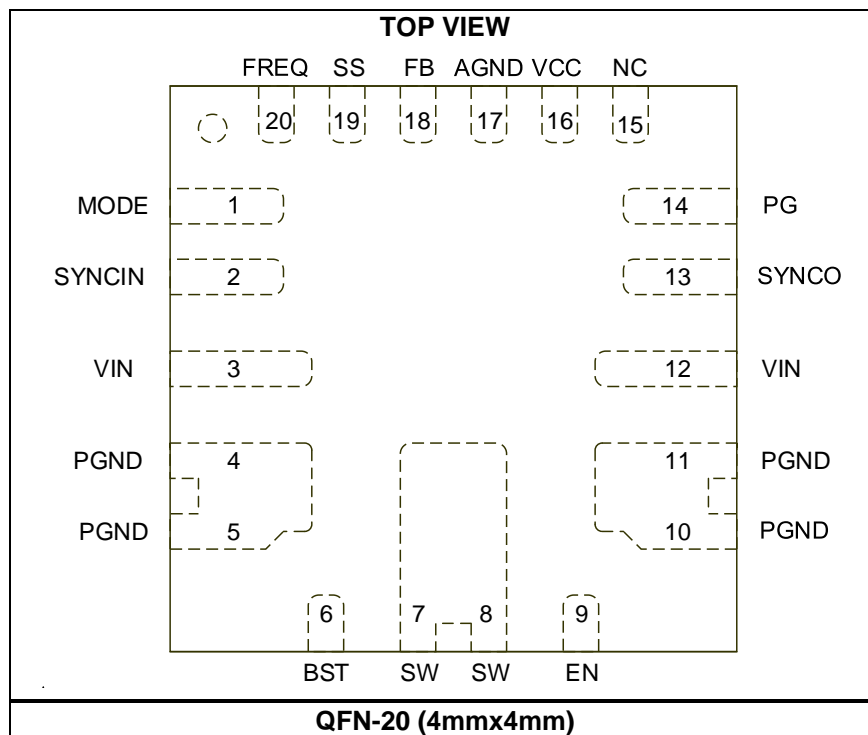

## PIN FUNCTIONS

Pin #	Name	Description
1	MODE	<b>AAM or FCCM selection pin.</b> Pull the MODE pin high to force the MP4315 to operate in forced continuous conduction mode (FCCM) under light loads. Pull MODE low to force the MP4315 to operate in advanced asynchronous mode (AAM) under light loads. Do not float this pin.
2	SYNCIN	<b>SYNC input.</b> Apply a 350kHz to 1000kHz clock signal to this pin to synchronize the internal oscillator frequency to the external clock. This pin is also used for multi-phase operation. The pin is internally in a high impedance state. Do not float this pin. Connect the SYNCIN pin to GND if it is not used. If using this pin, ensure that the external sync clock has an adequate pull-up and pull-down capability. It is recommended to place a $\leq 51\text{k}\Omega$ resistor between the pin and GND if the external sync clock's pull-down capability is not sufficient, or the pin enters a high-impedance state.
3, 12	VIN	<b>Input supply.</b> VIN supplies power to all the internal control circuitry, as well as the power switch connected to SW. To minimize switching spikes, it is recommended to connect a decoupling capacitor from VIN to ground.
4, 5, 10, 11	PGND	<b>Power ground.</b>
6	BST	<b>Bootstrap.</b> BST is the positive power supply for the high-side MOSFET (HS-FET) connected to SW. Connect a bypass capacitor between the BST and SW pins. See the External BST Diode and Resistor section on page 29 to calculate the size of this capacitor.
7, 8	SW	<b>Switch node.</b> SW is the output of the internal power switch.
9	EN	<b>Enable.</b> Pull the EN pin below the specified threshold (0.85V) to shut down the MP4315. Pull EN above the specified threshold (1V) to enable the MP4315.
13	SYNCO	<b>SYNC output.</b> The SYNCO pin outputs a clock signal that is 180° out of phase with the internal oscillator signal, or the opposite of the clock signal applied at the SYNCIN pin. Float the SYNCO pin if it is not used.
14	PG	<b>Power good indicator.</b> The output of PG is an open drain. If this pin is used, connect PG to a power source using a pull-up resistor. PG goes high if the output voltage ( $V_{OUT}$ ) is within 93% to 106% of the nominal voltage. PG goes low if $V_{OUT}$ is above 107.5% or below 91% of the nominal voltage.
15	NC	<b>Not connected.</b> Connect NC to the VCC pin or the output ( $\geq 3\text{V}$ ). Do not float this pin.
16	VCC	<b>Bias supply.</b> The VCC pin supplies 4.9V to the internal control circuit and gate drivers. Connect a decoupling capacitor from VCC to ground, and close to this pin. See the Setting the VCC Capacitor section on page 29 to calculate the size of this capacitor.
17	AGND	<b>Analog ground.</b>
18	FB	<b>Feedback input.</b> Connect FB to the center point of the external resistor divider. The feedback threshold voltage is about 0.815V.
19	SS	<b>Soft-start input.</b> Place a capacitor from SS to GND to set the soft-start time. The MP4315 sources 6 $\mu\text{A}$ from the SS pin to the soft-start capacitor ( $C_{SS}$ ) at start-up. As the SS voltage ( $V_{SS}$ ) rises, the feedback threshold voltage increases to limit inrush current during start-up.
20	FREQ	<b>Switching frequency configuration.</b> Connect a resistor from this pin to ground to set the switching frequency ( $f_{SW}$ ). See the $f_{SW}$ vs. $R_{FREQ}$ curve in the Typical Performance Characteristics section on page 13 to set the frequency.

**ABSOLUTE MAXIMUM RATINGS** <sup>(1)</sup>

VIN, EN .....	-0.3V to +50V
SW .....	-0.3V to V <sub>IN(MAX)</sub> + 0.3V
BST .....	V <sub>SW</sub> + 5.5V
All Other Pins .....	-0.3V to +5.5V
Continuous Power Dissipation (T <sub>A</sub> = 25°C) <sup>(2) (5)</sup>	
QFN-20 (4mmx4mm) .....	5.4W
Operating junction temperature .....	+150°C
Lead temperature .....	+260°C
Storage temperature .....	-65°C to +150°C

**Electrostatic Discharge (ESD) Ratings**

Human body model (HBM) .....	±2kV
Charged device model (CDM) .....	±750V

**Recommended Operating Conditions**

Supply Voltage V <sub>IN</sub> .....	3.3V to 45V
Output Voltage V <sub>OUT</sub> .....	0.815V to 0.95 x V <sub>IN</sub>
Operating junction temp (T <sub>J</sub> ) .....	-40°C to +125°C <sup>(3)</sup>

<b>Thermal Resistance</b>	<b>θ<sub>JA</sub></b>	<b>θ<sub>JC</sub></b>
QFN-20 (4mmx4mm)		
JESD51-7 <sup>(4)</sup> .....	44.....	9.....°C/W
EVQ4315-R-00A <sup>(5)</sup> .....	23.....	2.5.....°C/W

**Notes:**

- 1) Exceeding these ratings may damage the device.
- 2) The maximum allowable power dissipation is a function of the maximum junction temperature, T<sub>J</sub> (MAX), the junction-to-ambient thermal resistance, θ<sub>JA</sub>, and the ambient temperature, T<sub>A</sub>. The maximum allowable continuous power dissipation at any ambient temperature is calculated by P<sub>D</sub> (MAX) = (T<sub>J</sub> (MAX) - T<sub>A</sub>) / θ<sub>JA</sub>. Exceeding the maximum allowable power dissipation can cause excessive die temperature, and the regulator may go into thermal shutdown. Internal thermal shutdown circuitry protects the device from permanent damage.
- 3) The device may be able to support operating junction temperatures above 125°C. Contact MPS for details.
- 4) Measured on JESD51-7, 4-layer PCB. The values given in this table are only valid for comparison with other packages and cannot be used for design purposes. These values were calculated in accordance with JESD51-7, and simulated on a specified JEDEC board. They do not represent the performance obtained in an actual application.
- 5) Measured on an MPS standard evaluation board, 9cmx9cm, 4-layer PCB.

## ELECTRICAL CHARACTERISTICS

V<sub>IN</sub> = 12V, V<sub>EN</sub> = 2V, T<sub>J</sub> = -40°C to +125°C <sup>(6)</sup>, typical values are at T<sub>J</sub> = 25°C, unless otherwise noted.

Parameter	Symbol	Condition	Min	Typ	Max	Units
V <sub>IN</sub> under-voltage lockout (UVLO) rising threshold	IN <sub>UVLO_RISING</sub>		2.8	3.0	3.2	V
V <sub>IN</sub> UVLO falling threshold	IN <sub>UVLO_FALLING</sub>		2.45	2.65	2.85	V
V <sub>IN</sub> UVLO hysteresis	IN <sub>UVLO_HYS</sub>			280		mV
VCC voltage	V <sub>CC</sub>	I <sub>VCC</sub> = 0A	4.6	4.9	5.2	V
VCC regulation		I <sub>VCC</sub> = 30mA		1	4	%
VCC current limit	I <sub>LIMIT_VCC</sub>	V <sub>CC</sub> = 4V	100			mA
V <sub>IN</sub> quiescent current	I <sub>q</sub>	V <sub>FB</sub> = 0.85V, no load, sleep mode		18	26	μA
V <sub>IN</sub> quiescent current (switching) <sup>(7)</sup>	I <sub>Q_ACTIVE</sub>	MODE = GND (AAM), switching, no load, R <sub>FB_UP</sub> = 1MΩ, R <sub>FB_DOWN</sub> = 324kΩ		20		μA
		MODE = high (FCCM), switching, f <sub>SW</sub> = 2MHz, no load,		40		mA
		MODE = high (FCCM), switching, f <sub>SW</sub> = 470kHz, no load,		9.5		mA
V <sub>IN</sub> shutdown current	I <sub>SHDN</sub>	EN = 0V		1.7	3.5	μA
FB voltage	V <sub>FB</sub>	V <sub>IN</sub> = 3.3V to 45V, T <sub>J</sub> = 25°C	0.807	0.815	0.823	V
		V <sub>IN</sub> = 3.3V to 45V	0.799	0.815	0.831	V
FB current	I <sub>FB</sub>	V <sub>FB</sub> = 0.85V	-50	0	+50	nA
Switching frequency	f <sub>SW</sub>	R <sub>FREQ</sub> = 62kΩ	420	470	520	kHz
		R <sub>FREQ</sub> = 26.1kΩ	820	1000	1180	
Minimum on time <sup>(7)</sup>	t <sub>ON_MIN</sub>			100		ns
Minimum off time <sup>(7)</sup>	t <sub>OFF_MIN</sub>			80		ns
SYNCIN voltage rising threshold	V <sub>SYNC_RISING</sub>		1.8			V
SYNCIN voltage falling threshold	V <sub>SYNC_FALLING</sub>				0.4	V
SYNCIN clock range	f <sub>SYNC</sub>	External clock	350		1000	kHz
SYNCO high voltage	V <sub>SYNCO_HIGH</sub>	I <sub>SYNCO</sub> = -1mA	3.3	4.5		V
SYNCO low voltage	V <sub>SYNCO_LOW</sub>	I <sub>SYNCO</sub> = 1mA			0.4	V
SYNCO phase shift		Tested under SYNCIN		180		deg
High-side current limit	I <sub>LIMIT</sub>	Duty cycle = 30%	6.4	8	9.6	A
Low-side valley current limit	I <sub>LIMIT_VALLEY</sub>		4.8	6	7.2	A

**ELECTRICAL CHARACTERISTICS (continued)**
**V<sub>IN</sub> = 12V, V<sub>EN</sub> = 2V, T<sub>J</sub> = -40°C to +125°C <sup>(6)</sup>, typical values are at T<sub>J</sub> = 25°C, unless otherwise noted.**

Parameter	Symbol	Condition	Min	Typ	Max	Units
Zero-current detection (ZCD) threshold	I <sub>ZCD</sub>	AAM	-0.15	0.1	+0.35	A
Low-side reverse current limit	I <sub>LIMIT_REVERSE</sub>	FCCM	2	4.5	7	A
Switch leakage current	I <sub>SW_LKG</sub>			0.01	1	μA
HS-FET on resistance	R <sub>ON_HS</sub>	V <sub>BST</sub> - V <sub>SW</sub> = 5V		48	80	mΩ
LS-FET on resistance	R <sub>ON_LS</sub>	V <sub>CC</sub> = 5V		20	40	mΩ
Soft-start current	I <sub>SS</sub>	V <sub>SS</sub> = 0V	4	6	8	μA
EN rising threshold	V <sub>EN_RISING</sub>		0.8	1	1.2	V
EN falling threshold	V <sub>EN_FALLING</sub>		0.65	0.85	1.05	V
EN hysteresis voltage	V <sub>EN_HYS</sub>			190		mV
MODE rising threshold	V <sub>MODE_RISING</sub>		1.8			V
MODE falling threshold	V <sub>MODE_FALLING</sub>				0.4	V
PG rising threshold (V <sub>FB</sub> / V <sub>REF</sub> )	P <sub>G</sub> <sub>RISING</sub>	V <sub>FB</sub> rising	88.5%	93%	97.5%	V <sub>REF</sub>
		V <sub>FB</sub> falling	101.5%	106%	110.5%	
PG falling threshold (V <sub>FB</sub> / V <sub>REF</sub> )	P <sub>G</sub> <sub>FALLING</sub>	V <sub>FB</sub> falling	86.5%	91%	95.5%	
		V <sub>FB</sub> rising	103%	107.5%	112%	
PG output voltage low	V <sub>PG_LOW</sub>	I <sub>SINK</sub> = 1mA		0.1	0.3	V
PG rising delay	t <sub>PG_R_DELAY</sub>			35		μs
PG falling delay	t <sub>PG_F_DELAY</sub>			35		μs
Thermal shutdown <sup>(7)</sup>	T <sub>SD</sub>			170		°C
Thermal shutdown hysteresis <sup>(7)</sup>	T <sub>SD_HYS</sub>			20		°C

**Notes:**

6) Not tested in production. Guaranteed by over-temperature correlation.

7) Guaranteed by characterization. Not tested in production.

## TYPICAL CHARACTERISTICS

$V_{IN} = 12V$ ,  $T_J = -40^{\circ}C$  to  $+125^{\circ}C$ , unless otherwise noted.

Quiescent Current vs. Temperature

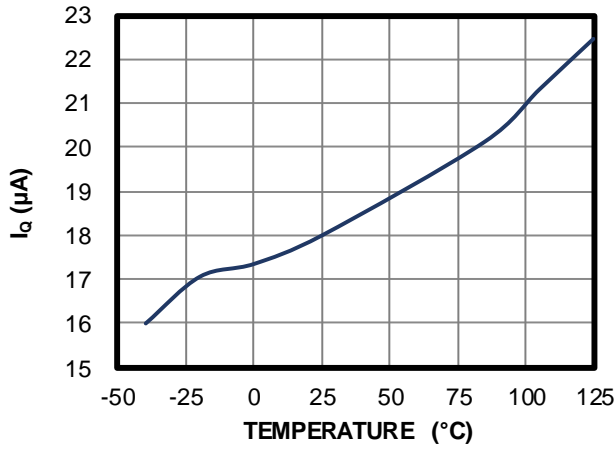

Feedback Voltage vs. Temperature

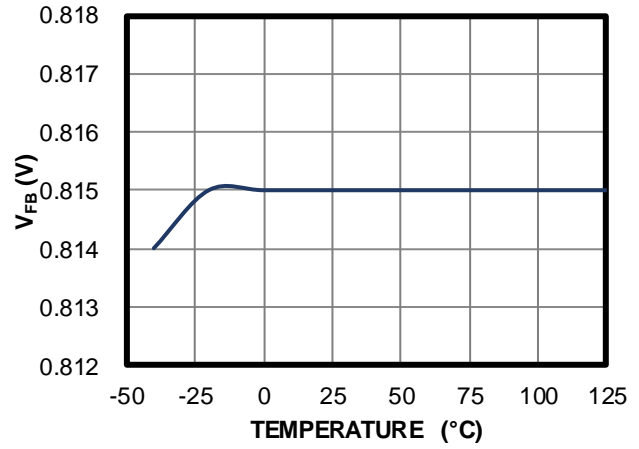

Current Limit vs. Temperature

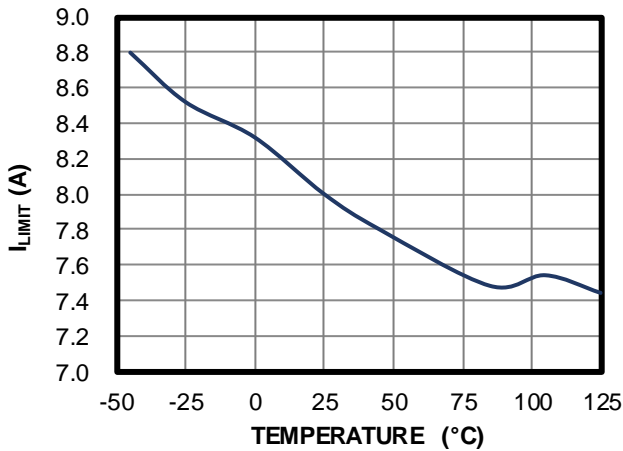

Valley Current Limit vs. Temperature

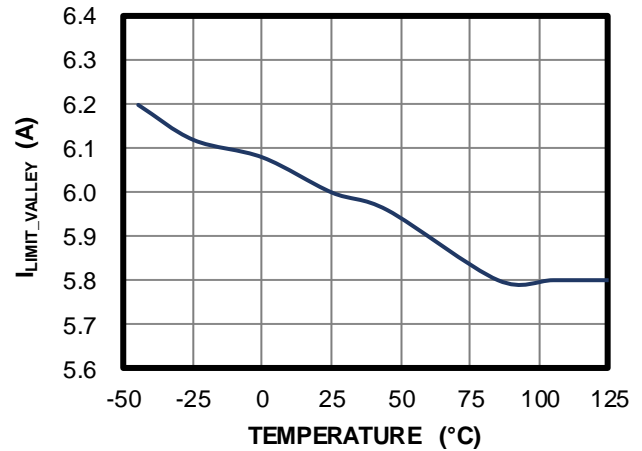

Reverse Current Limit vs. Temperature

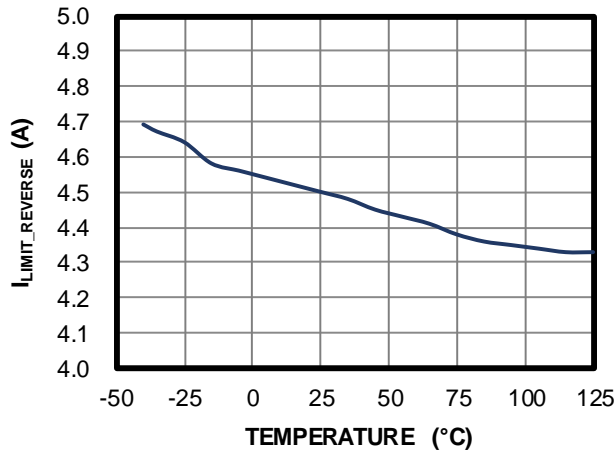

$V_{IN}$  UVLO Threshold vs. Temperature

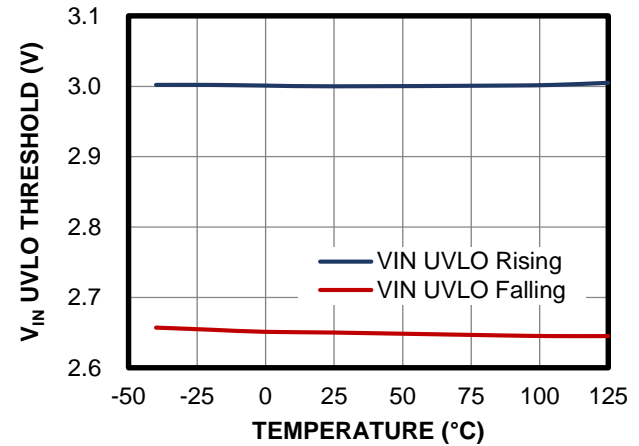



**TYPICAL CHARACTERISTICS (continued)**

 V<sub>IN</sub> = 12V, T<sub>J</sub> = -40°C to +125°C, unless otherwise noted.

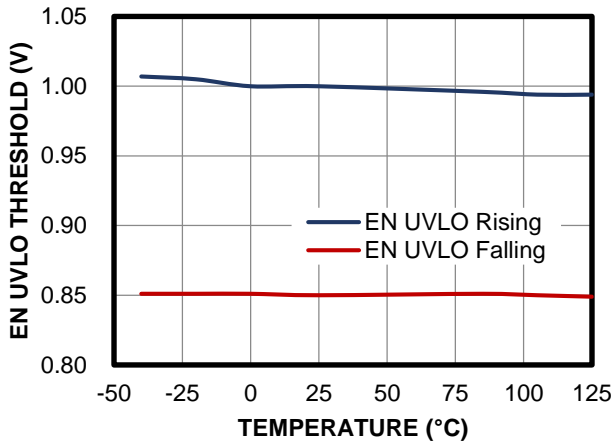
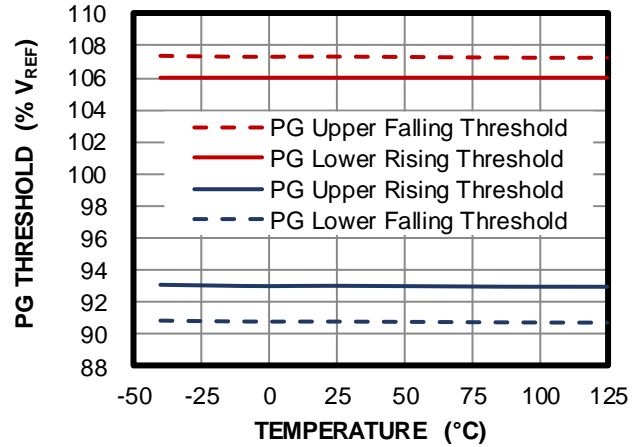
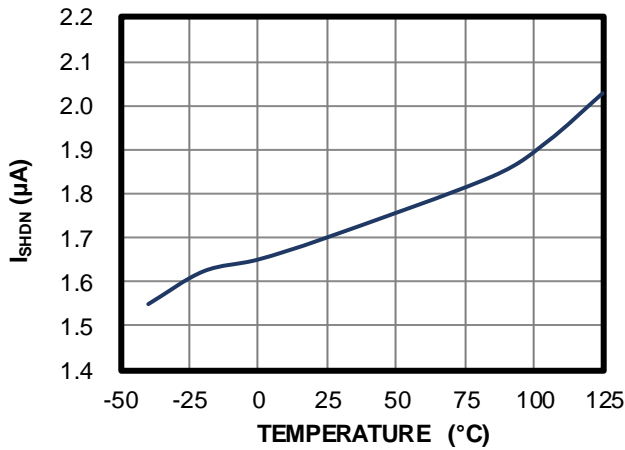
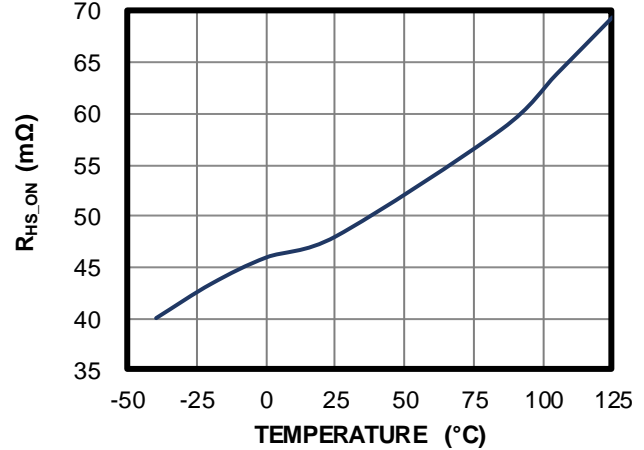
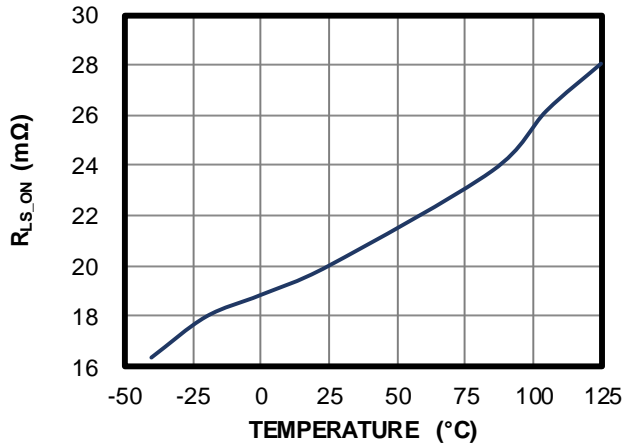
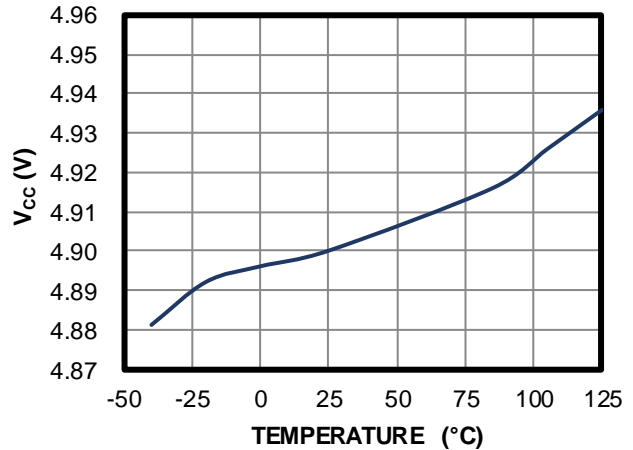
**EN UVLO Threshold vs. Temperature**

**PG Rising/Falling Threshold vs. Temperature**

**VIN Shutdown Current vs. Temperature**

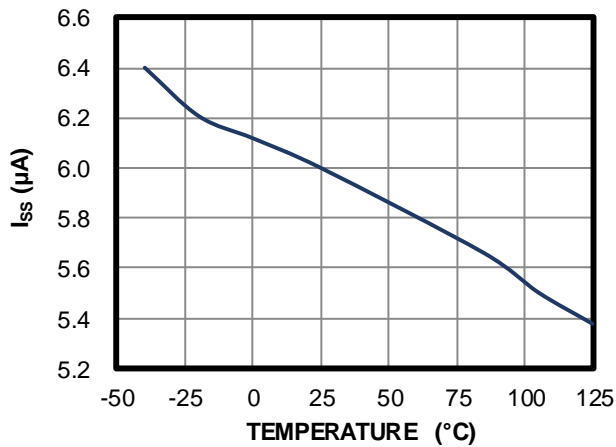
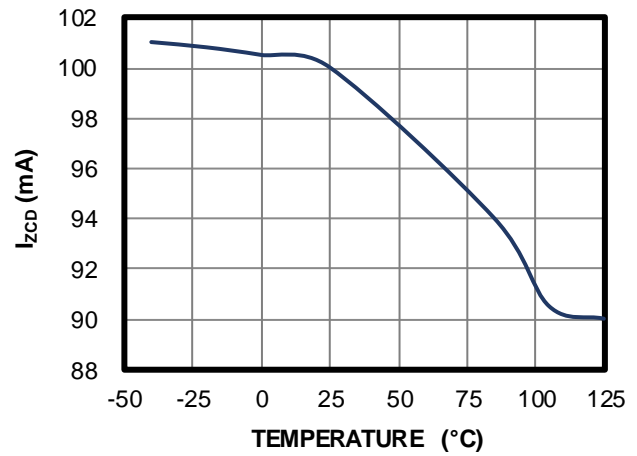
**R<sub>HS\_ON</sub> vs. Temperature**

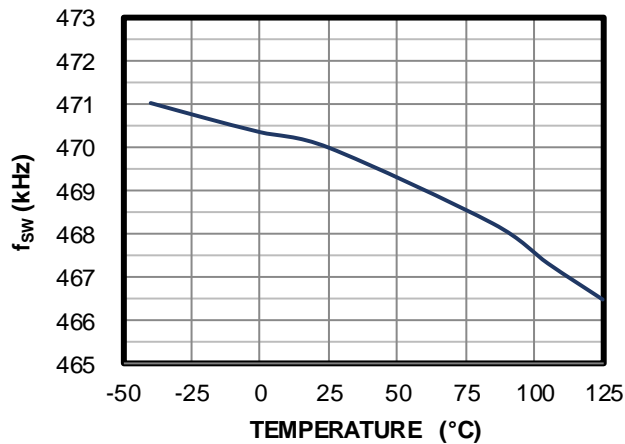
**R<sub>LS\_ON</sub> vs. Temperature**

**V<sub>CC</sub> Voltage vs. Temperature**

**TYPICAL CHARACTERISTICS (continued)**

 V<sub>IN</sub> = 12V, T<sub>J</sub> = -40°C to +125°C, unless otherwise noted.

**Soft-Start Current vs. Temperature**

**Zero-Current Detection Threshold vs. Temperature**

**Switching Frequency vs. Temperature**

 R<sub>FREQ</sub> = 62kΩ

## TYPICAL PERFORMANCE CHARACTERISTICS

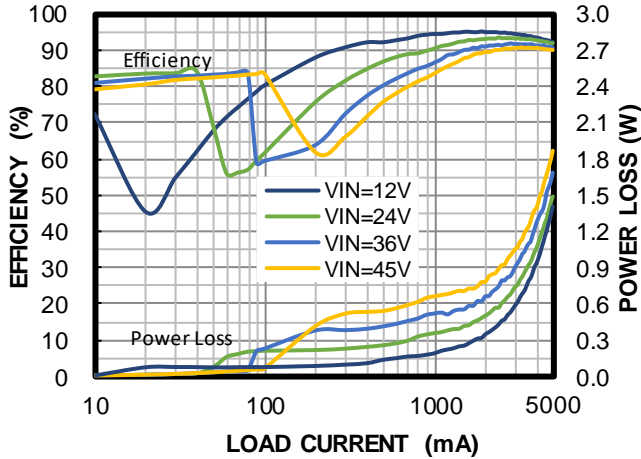
V<sub>IN</sub> = 12V, V<sub>OUT</sub> = 3.3V, L = 4.7μH, f<sub>SW</sub> = 470kHz, AAM, T<sub>A</sub> = 25°C, unless otherwise noted.

**Efficiency vs. Load Current vs. Power Loss**  
AAM, V<sub>OUT</sub> = 3.3V, L = 4.7μH<sup>(8)</sup>



**Efficiency vs. Load Current vs. Power Loss**  
FCCM, V<sub>OUT</sub> = 3.3V, L = 4.7μH<sup>(8)</sup>

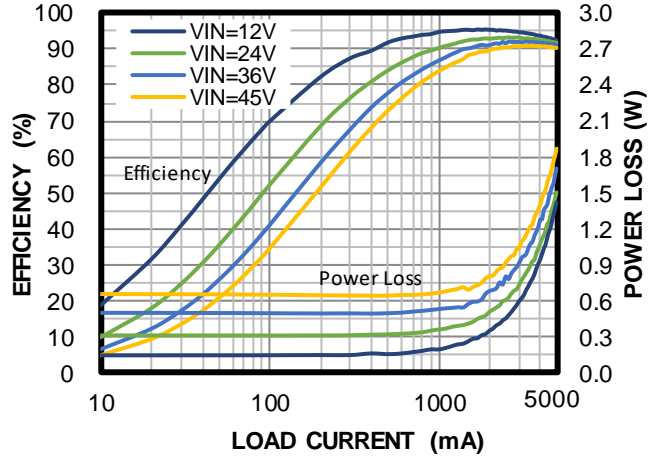

**Efficiency vs. Load Current vs. Power Loss**  
AAM, V<sub>OUT</sub> = 5V, L = 4.7μH<sup>(8)</sup>

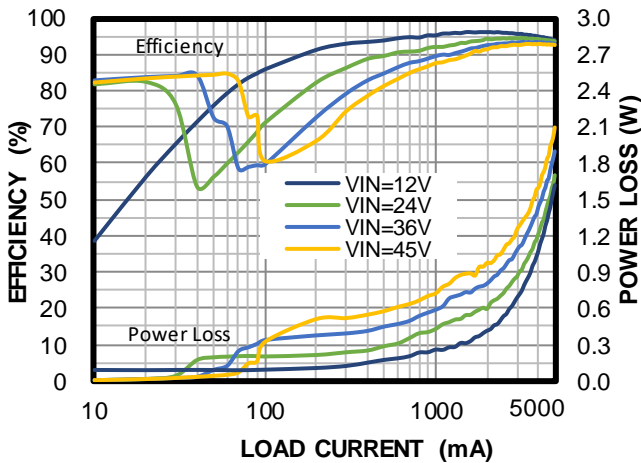

**Efficiency vs. Load Current vs. Power Loss**  
FCCM, V<sub>OUT</sub> = 5V, L = 4.7μH<sup>(8)</sup>

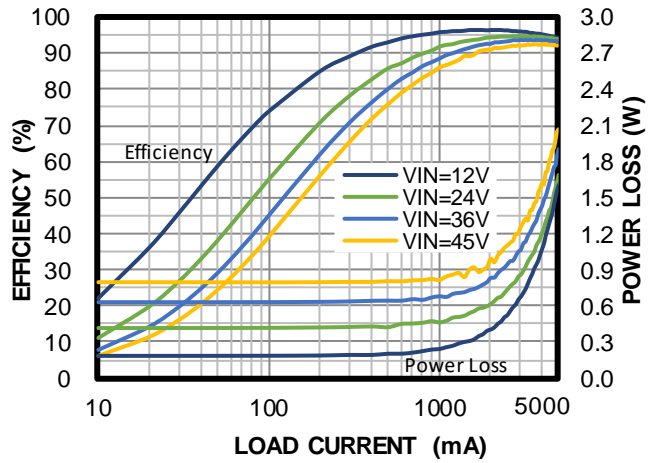

**Load Regulation**  
AAM

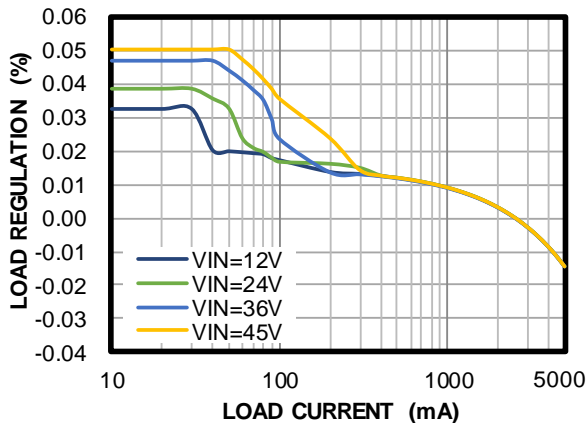

**Load Regulation**  
FCCM

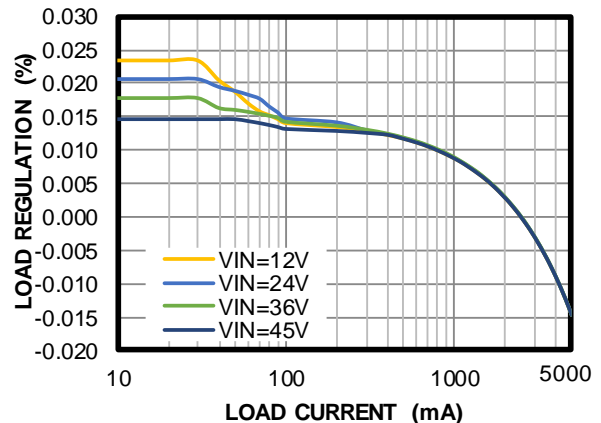

### TYPICAL PERFORMANCE CHARACTERISTICS (continued)

V<sub>IN</sub> = 12V, V<sub>OUT</sub> = 3.3V, L = 4.7μH, f<sub>SW</sub> = 470kHz, AAM, T<sub>A</sub> = 25°C, unless otherwise noted.

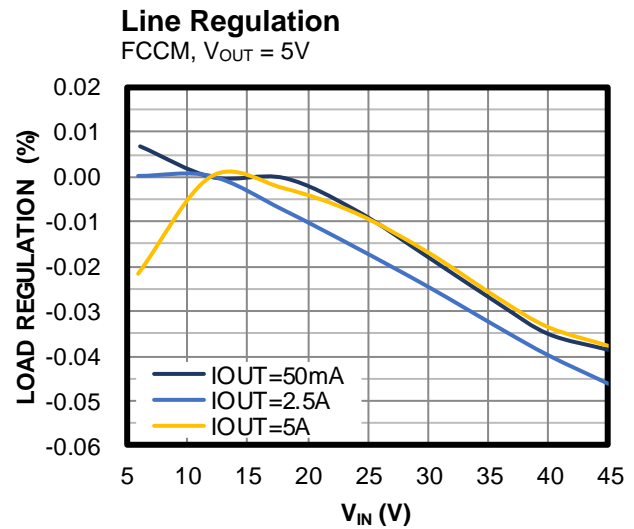
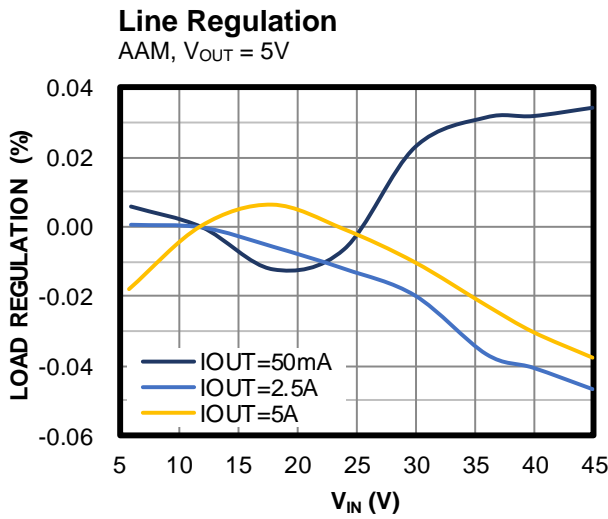
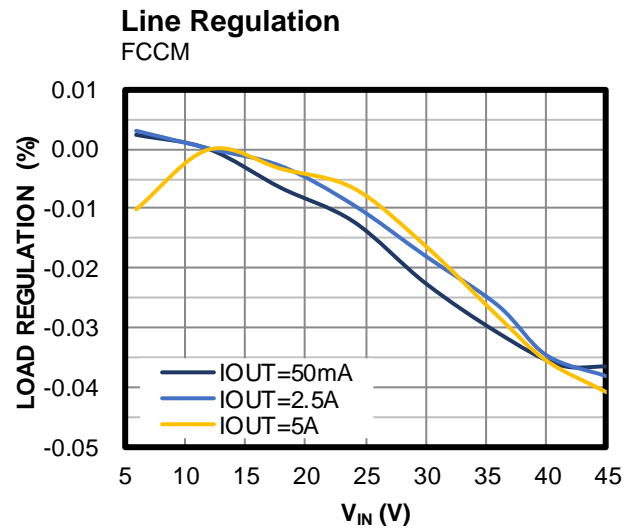
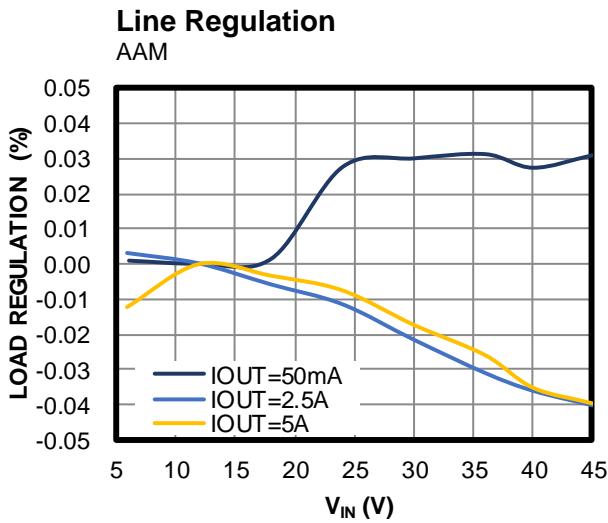
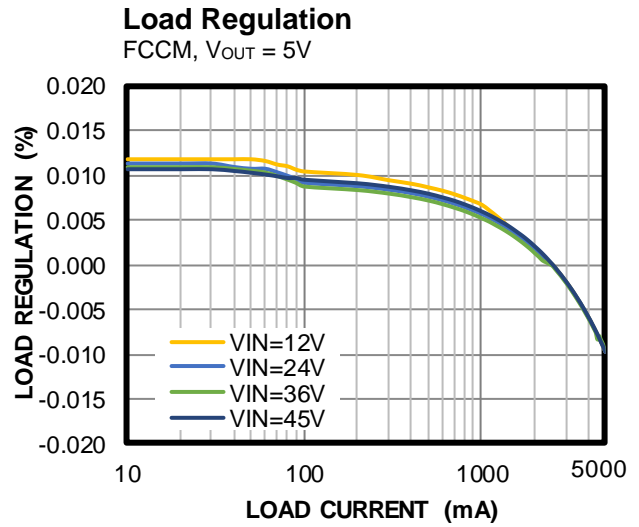
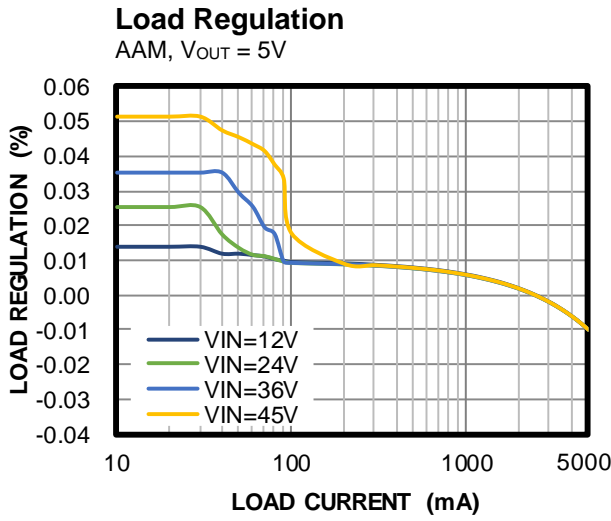

### TYPICAL PERFORMANCE CHARACTERISTICS (continued)

V<sub>IN</sub> = 12V, V<sub>OUT</sub> = 3.3V, L = 4.7μH, f<sub>SW</sub> = 470kHz, AAM, T<sub>A</sub> = 25°C, unless otherwise noted.

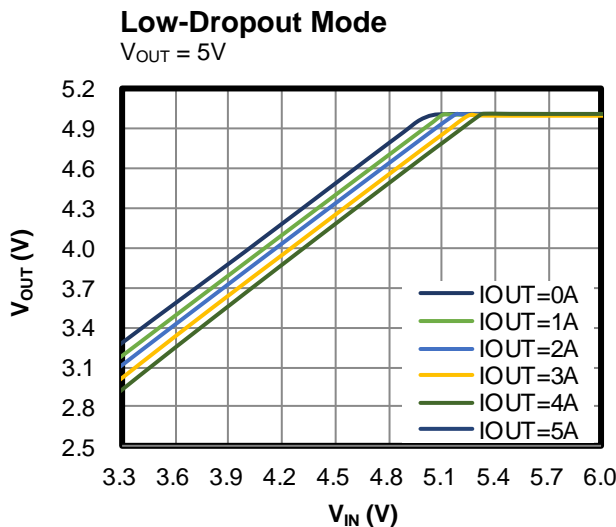
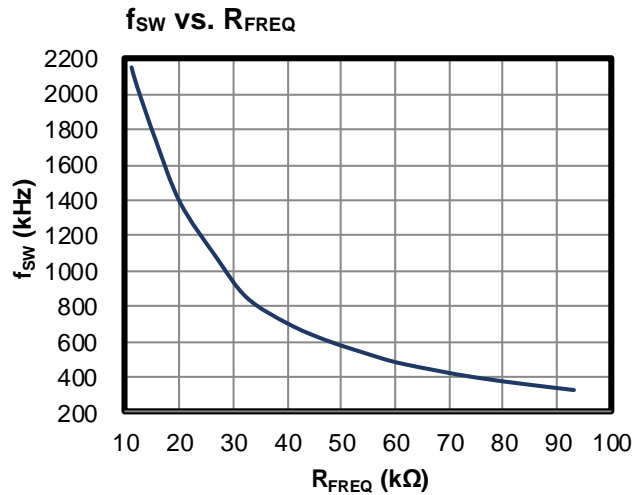
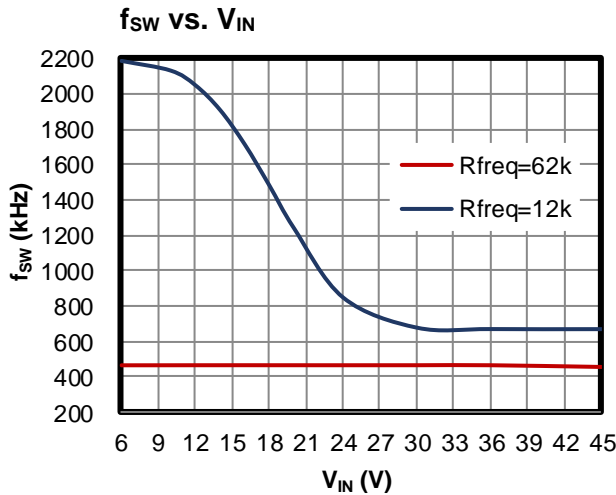
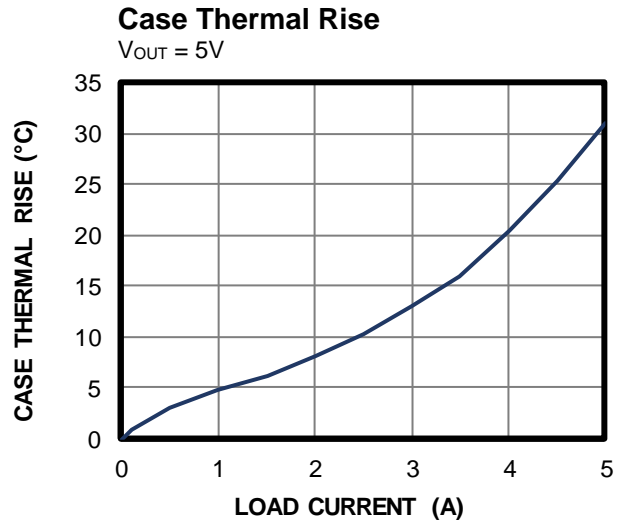
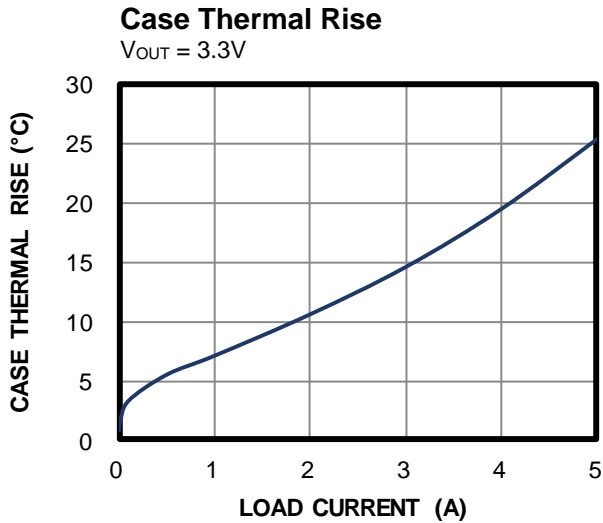

## TYPICAL PERFORMANCE CHARACTERISTICS (continued)

V<sub>IN</sub> = 12V, V<sub>OUT</sub> = 5V, I<sub>OUT</sub> = 5A, L = 4.7μH, f<sub>SW</sub> = 470kHz, T<sub>A</sub> = 25°C, unless otherwise noted. <sup>(9)</sup>

### CISPR25 Class 5 Peak Conducted Emissions

150kHz to 108MHz

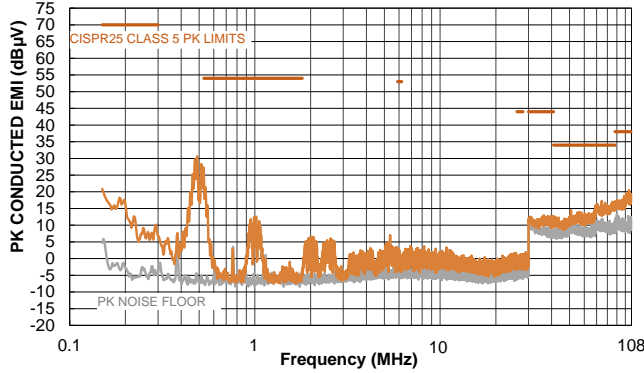

### CISPR25 Class 5 Average Conducted Emissions

150kHz to 108MHz

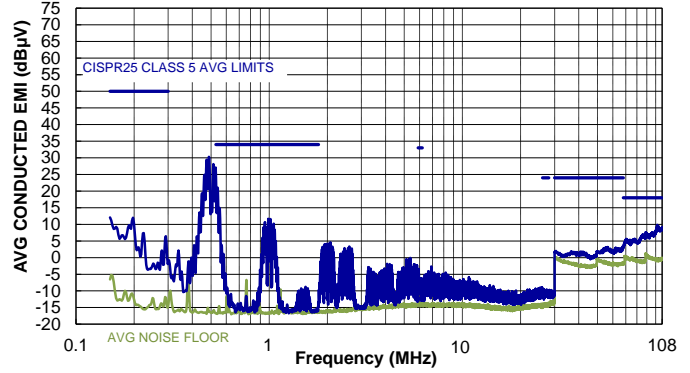

### CISPR25 Class 5 Peak Radiated Emissions

150kHz to 30MHz

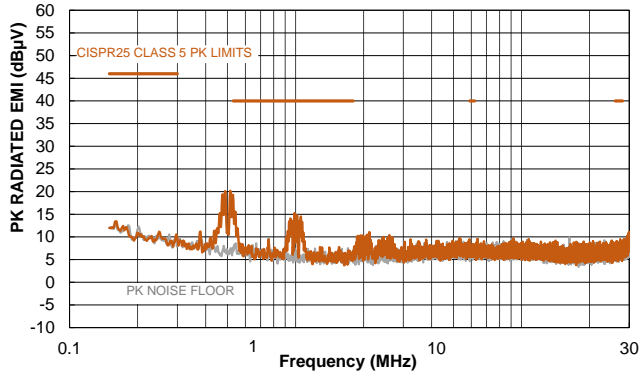

### CISPR25 Class 5 Average Radiated Emissions

150kHz to 30MHz

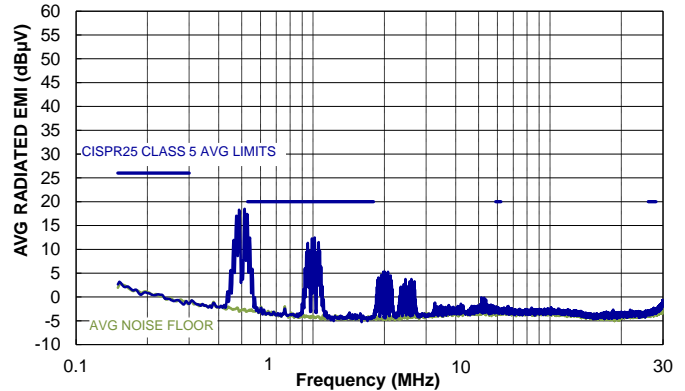

### CISPR25 Class 5 Peak Radiated Emissions

Horizontal, 30MHz to 1GHz

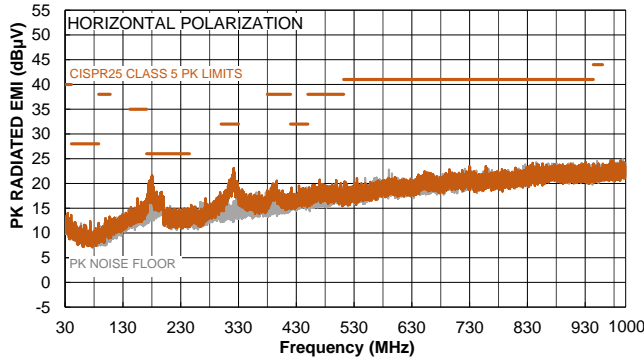

### CISPR25 Class 5 Average Radiated Emissions

Horizontal, 30MHz to 1GHz

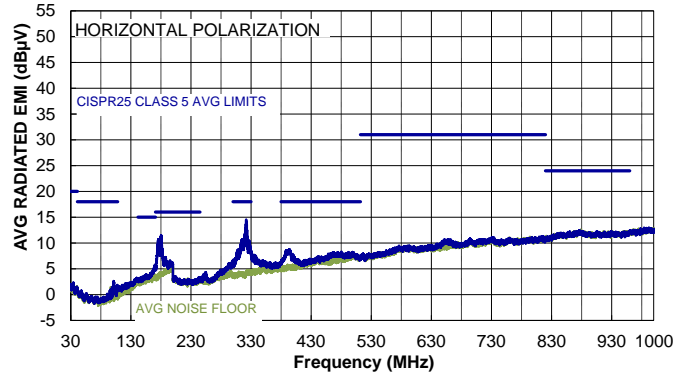

## TYPICAL PERFORMANCE CHARACTERISTICS *(continued)*

V<sub>IN</sub> = 12V, V<sub>OUT</sub> = 5V, I<sub>OUT</sub> = 5A, L = 4.7μH, f<sub>SW</sub> = 470kHz, T<sub>A</sub> = 25°C, unless otherwise noted. <sup>(9)</sup>

### CISPR25 Class 5 Peak Radiated Emissions

Vertical, 30MHz to 1GHz

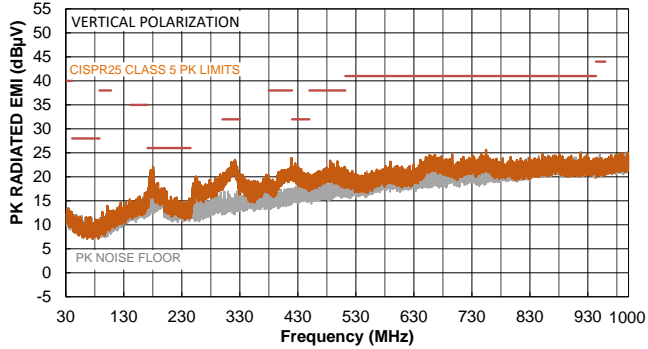

### CISPR25 Class 5 Average Radiated Emissions

Vertical, 30MHz to 1GHz

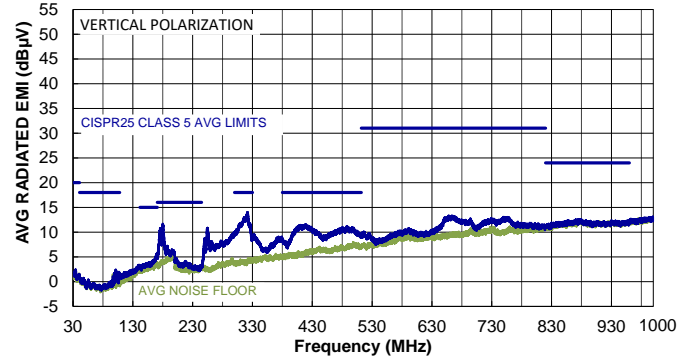

#### Notes:

- 8) Inductor part number: XAL6060-472MEC. DCR = 15.02mΩ.
- 9) EMC test results are based on the application circuit with EMI filters (see Figure 11 in the Typical Application Circuits section on page 31).

**TYPICAL PERFORMANCE CHARACTERISTICS (continued)**

 V<sub>IN</sub> = 12V, V<sub>OUT</sub> = 3.3V, L = 4.7μH, f<sub>sw</sub> = 470kHz, AAM, T<sub>A</sub> = 25°C, unless otherwise noted.

**Steady State**

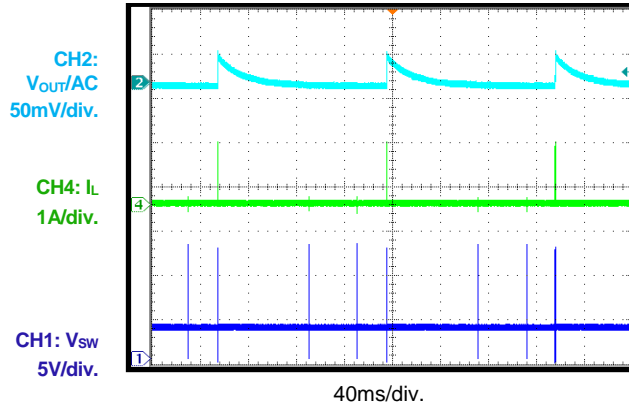
 I<sub>OUT</sub> = 0A, AAM

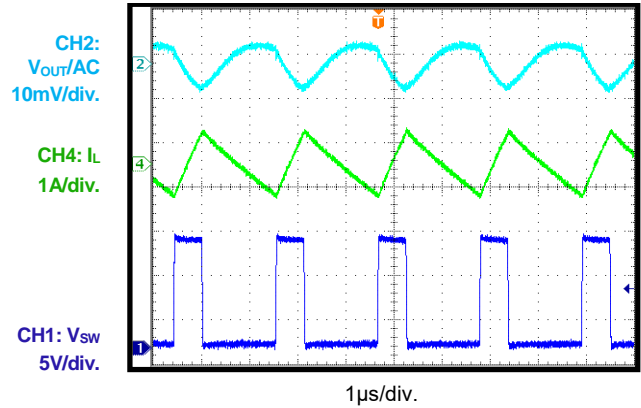
**Steady State**

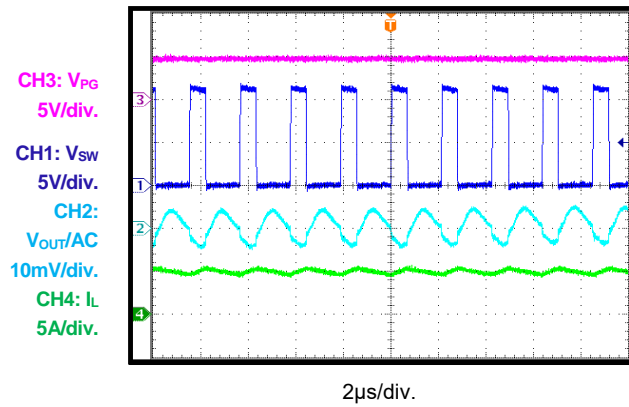
 I<sub>OUT</sub> = 0A, FCCM

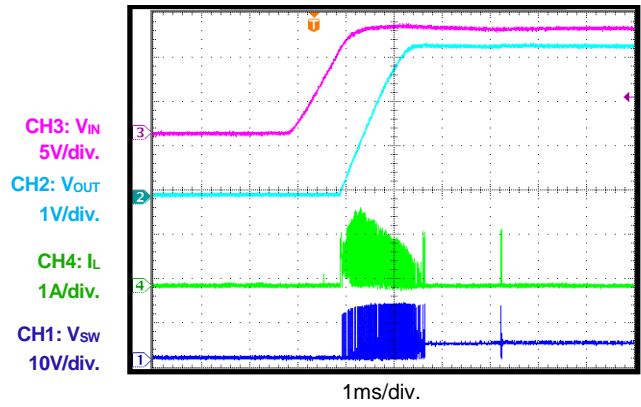
**Steady State**

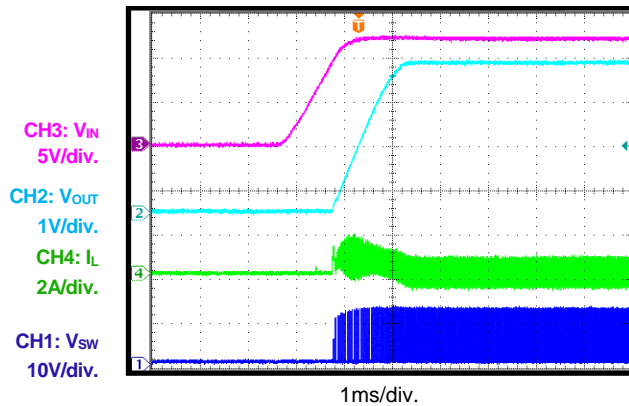
 I<sub>OUT</sub> = 5A

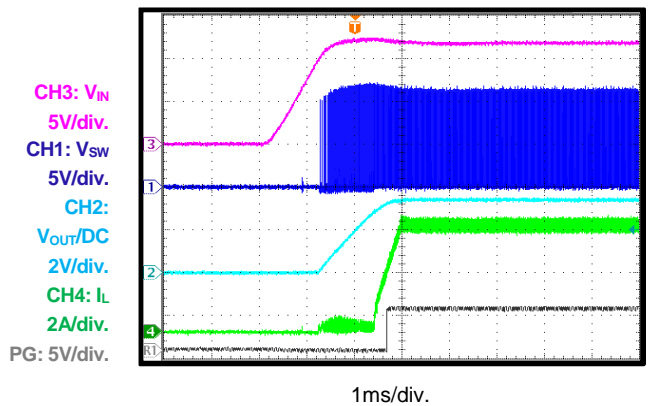
**Start-Up through VIN**

 I<sub>OUT</sub> = 0A, AAM

**Start-Up through VIN**

 I<sub>OUT</sub> = 0A, FCCM

**Start-Up through VIN**

 I<sub>OUT</sub> = 5A

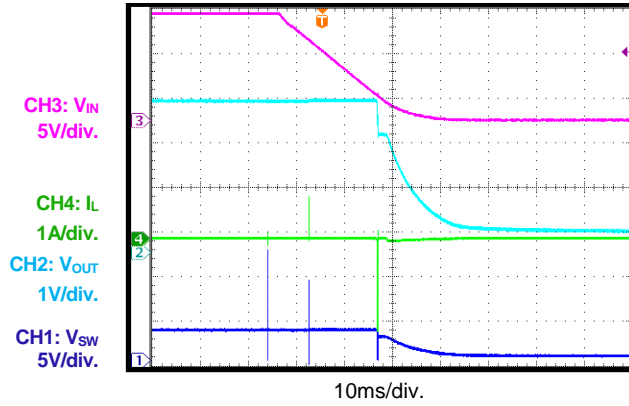
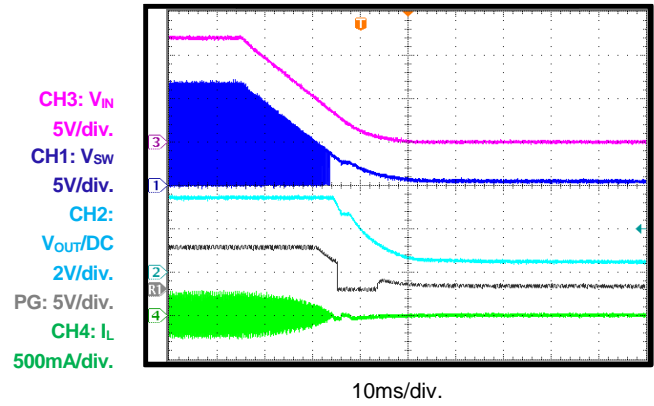
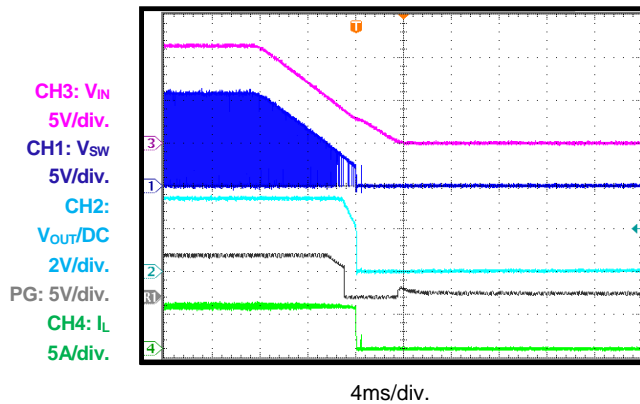
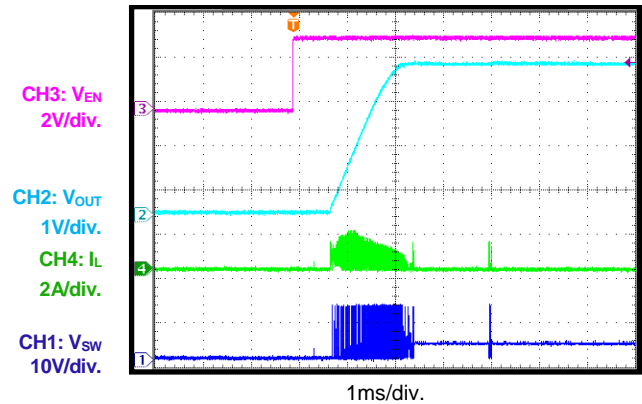
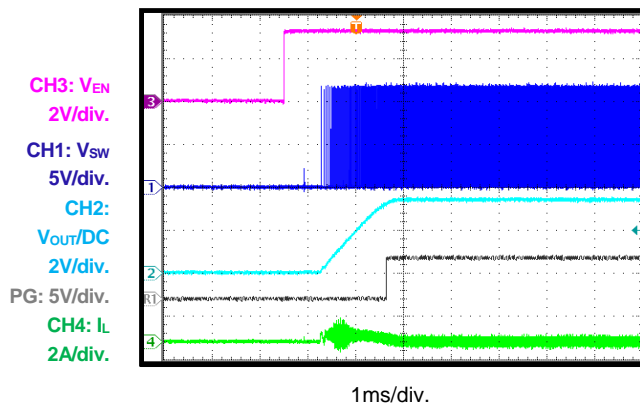
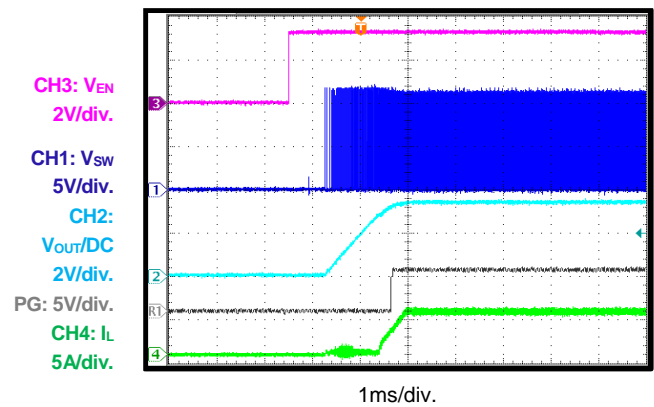

**TYPICAL PERFORMANCE CHARACTERISTICS (continued)**
 $V_{IN} = 12V$ ,  $V_{OUT} = 3.3V$ ,  $L = 4.7\mu H$ ,  $f_{SW} = 470kHz$ , AAM,  $T_A = 25^{\circ}C$ , unless otherwise noted.

**Shutdown through VIN**
 $I_{OUT} = 0A$ , AAM

**Shutdown through VIN**
 $I_{OUT} = 0A$ , FCCM

**Shutdown through VIN**
 $I_{OUT} = 5A$ 

**Start-Up through EN**
 $I_{OUT} = 0A$ , AAM

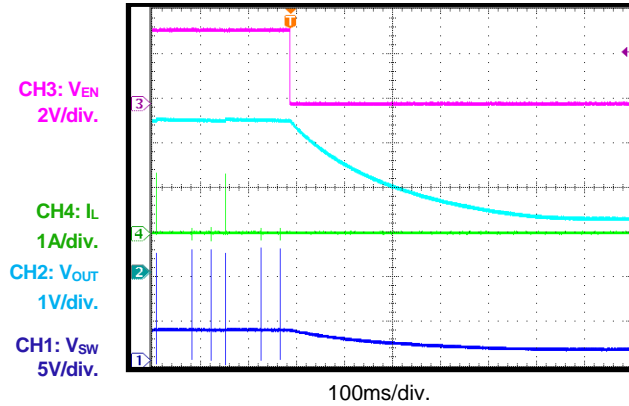
**Start-Up through EN**
 $I_{OUT} = 0A$ , FCCM

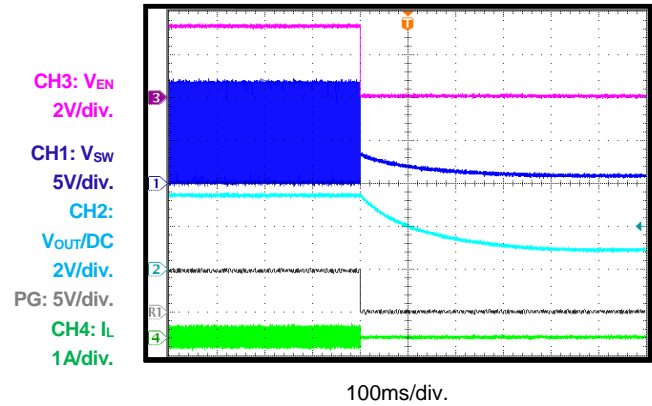
**Start-Up through EN**
 $I_{OUT} = 5A$ 

**TYPICAL PERFORMANCE CHARACTERISTICS (continued)**

 V<sub>IN</sub> = 12V, V<sub>OUT</sub> = 3.3V, L = 4.7μH, f<sub>SW</sub> = 470kHz, AAM, T<sub>A</sub> = 25°C, unless otherwise noted.

**Shutdown through EN**

 I<sub>OUT</sub> = 0A, AAM

**Shutdown through EN**

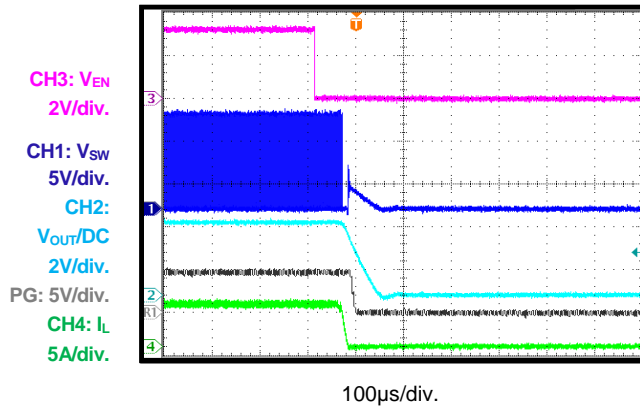
 I<sub>OUT</sub> = 0A, FCCM

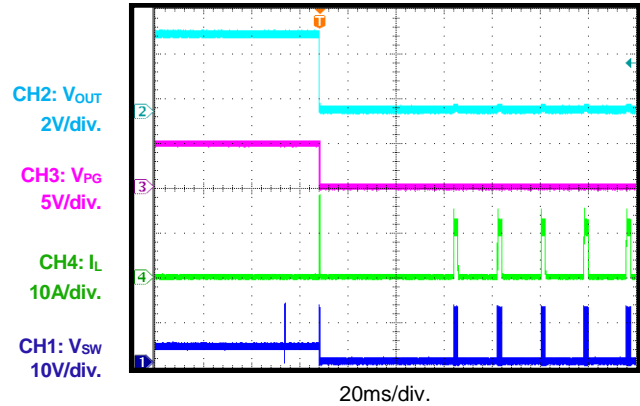
**Shutdown through EN**

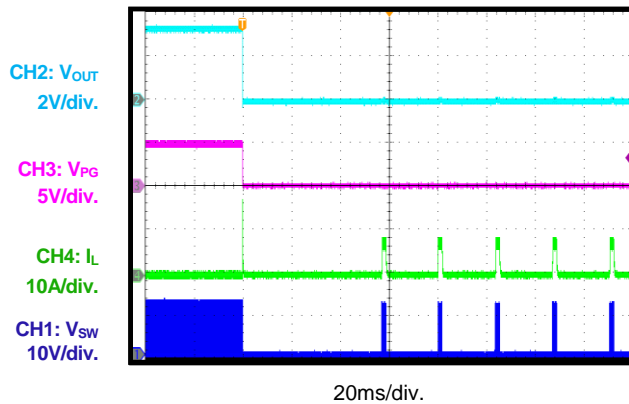
 I<sub>OUT</sub> = 5A

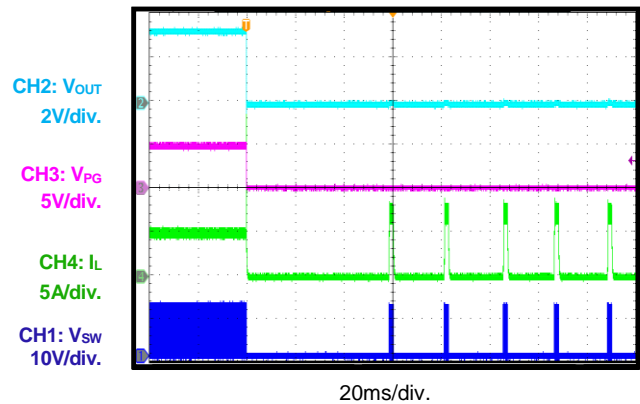
**SCP Entry**

 I<sub>OUT</sub> = 0A, AAM

**SCP Entry**

 I<sub>OUT</sub> = 0A, FCCM

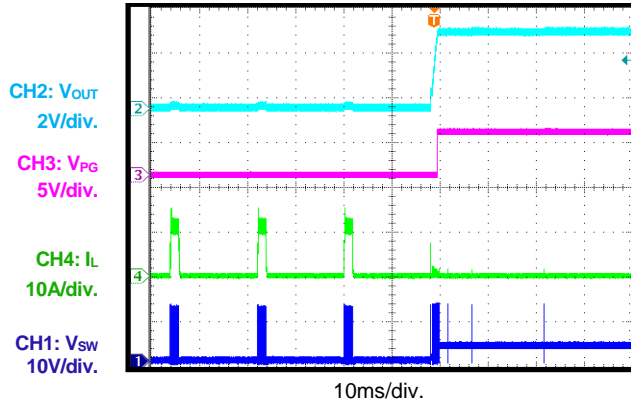
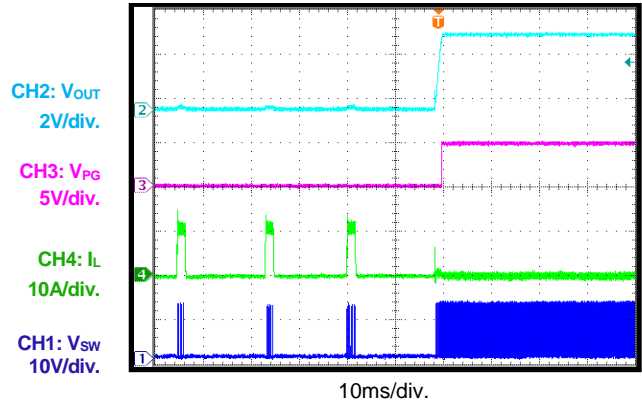
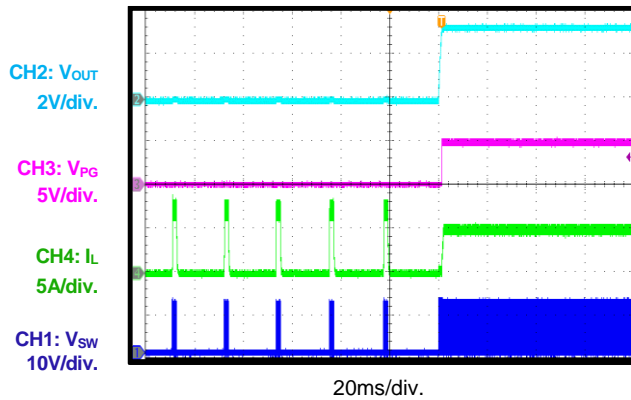
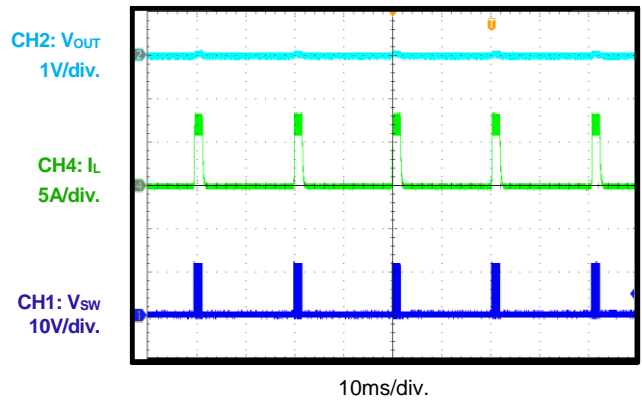
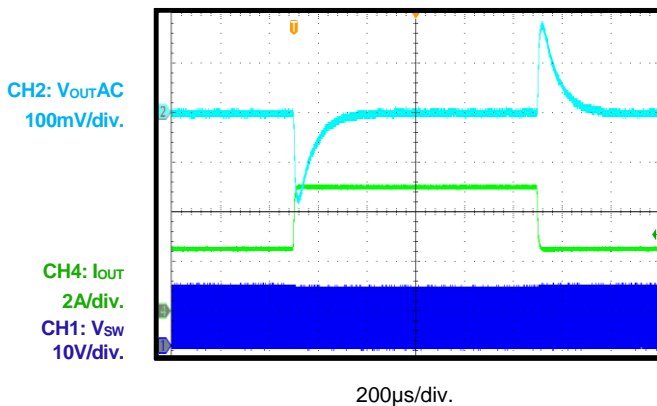
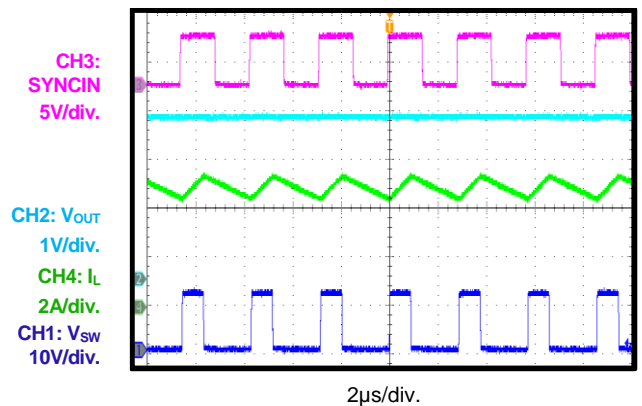
**SCP Entry**

 I<sub>OUT</sub> = 5A

**TYPICAL PERFORMANCE CHARACTERISTICS (continued)**
 $V_{IN} = 12V$ ,  $V_{OUT} = 3.3V$ ,  $L = 4.7\mu H$ ,  $f_{SW} = 470kHz$ , AAM,  $T_A = 25^\circ C$ , unless otherwise noted.

**SCP Recovery**
 $I_{OUT} = 0A$ , AAM

**SCP Recovery**
 $I_{OUT} = 0A$ , FCCM

**SCP Recovery**
 $I_{OUT} = 5A$ 

**SCP Steady State**

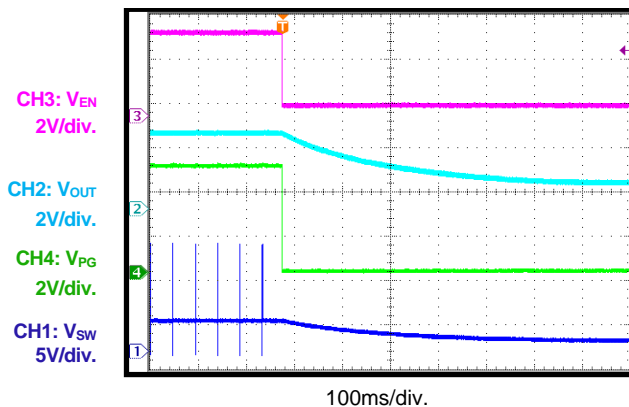
**Load Transient**
 $I_{OUT} = 2.5A$  to  $5A$ ,  $1.6A/\mu s$ 

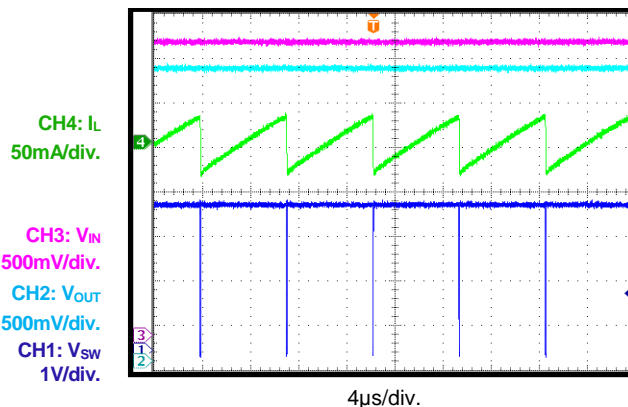
**SYNC Operation**
 $I_{OUT} = 5A$ , SYNC frequency = 350kHz

**TYPICAL PERFORMANCE CHARACTERISTICS (continued)**

 V<sub>IN</sub> = 12V, V<sub>OUT</sub> = 3.3V, L = 4.7μH, f<sub>SW</sub> = 470kHz, AAM, T<sub>A</sub> = 25°C, unless otherwise noted.

**PG in Shutdown through EN**

 I<sub>OUT</sub> = 0A, AAM

**Low-Dropout Mode**

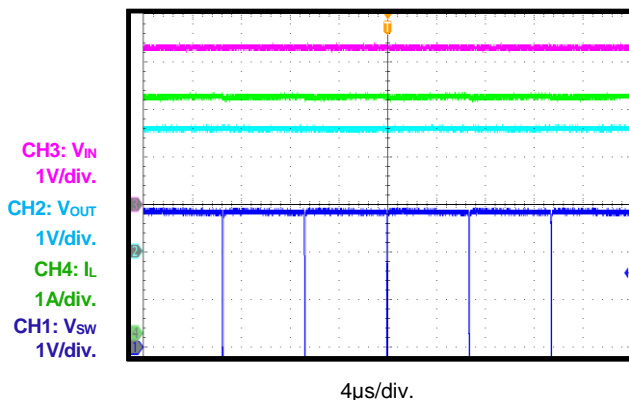
 V<sub>IN</sub> = 3.3V, V<sub>OUT</sub> set to 3.3V, I<sub>OUT</sub> = 0A

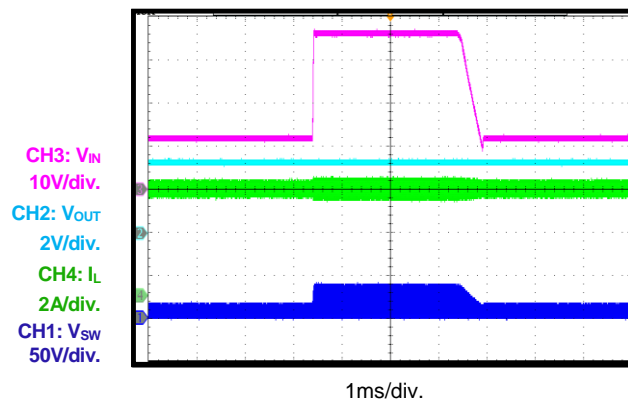
**Low-Dropout Mode**

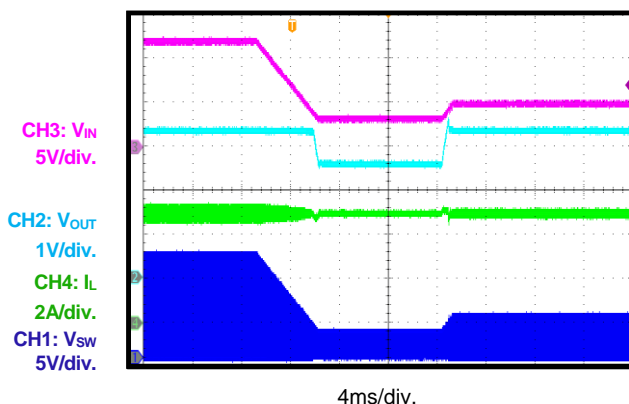
 V<sub>IN</sub> = 3.3V, V<sub>OUT</sub> set to 3.3V, I<sub>OUT</sub> = 5A

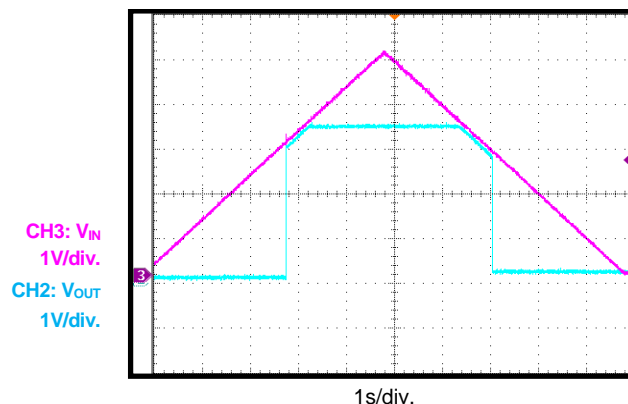
**Load Dump**

 V<sub>IN</sub> = 12V to 36V, I<sub>OUT</sub> = 5A

**Cold Crank**

 V<sub>IN</sub> = 12V to 3.3V to 5V, I<sub>OUT</sub> = 5A

**V<sub>IN</sub> Ramp Up and Down**

 I<sub>OUT</sub> = 0.1A

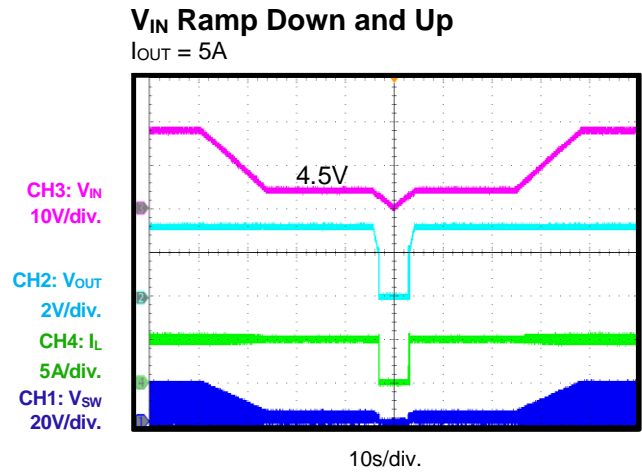
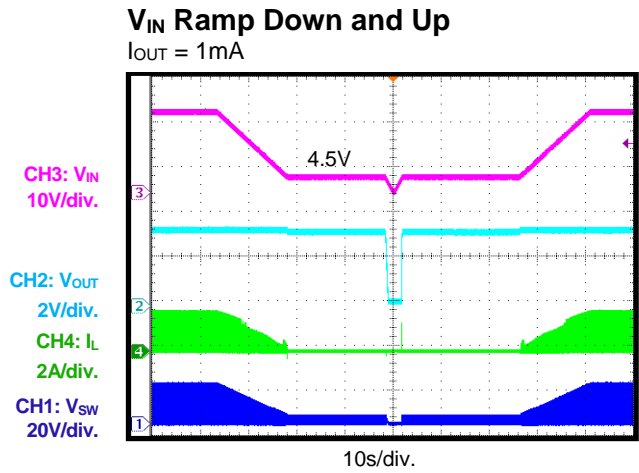
### TYPICAL PERFORMANCE CHARACTERISTICS (continued)

V<sub>IN</sub> = 12V, V<sub>OUT</sub> = 3.3V, L = 4.7μH, f<sub>SW</sub> = 470kHz, AAM, T<sub>A</sub> = 25°C, unless otherwise noted.



## FUNCTIONAL BLOCK DIAGRAM

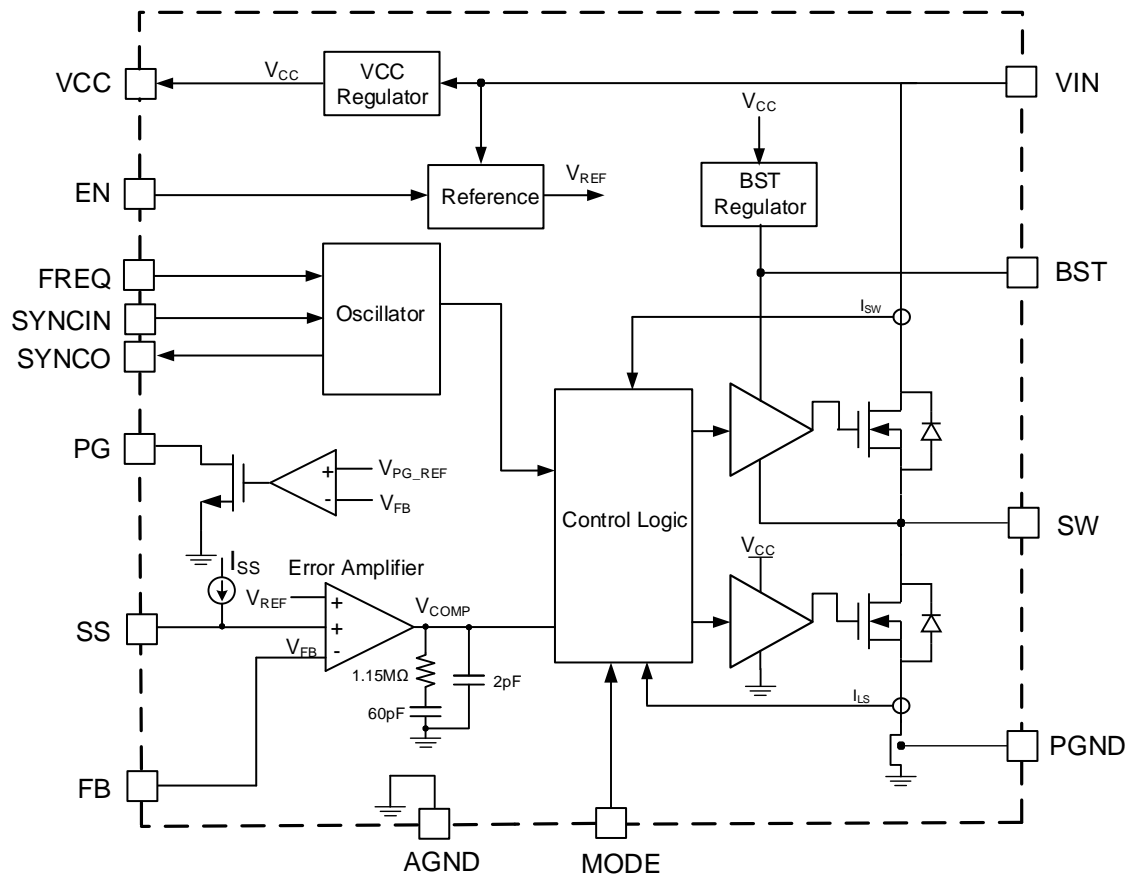

Figure 1: Functional Block Diagram

Timing Sequence

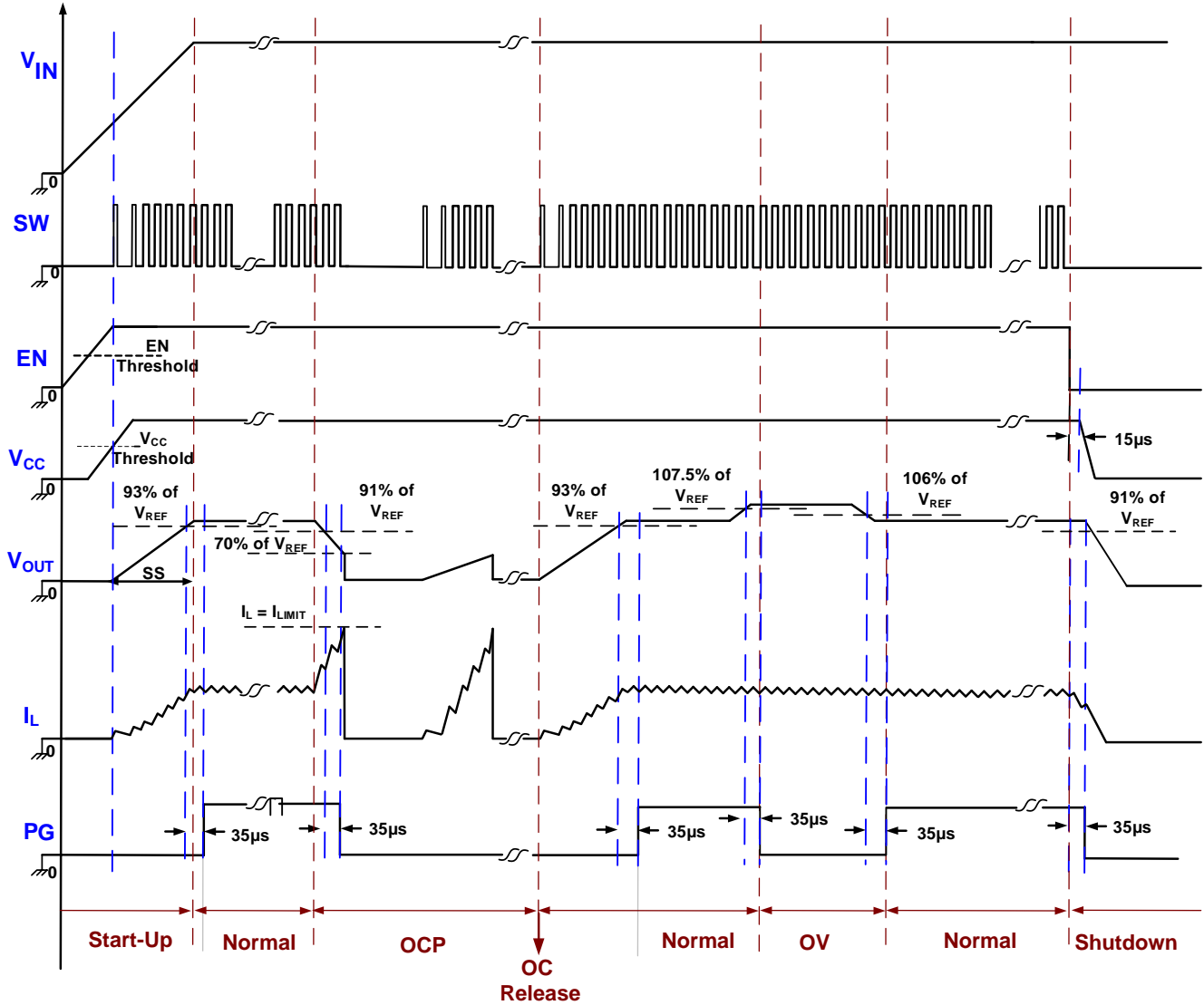

Figure 2: Timing Sequence

## OPERATION

The MP4315 is a synchronous, step-down switching regulator with integrated internal high-side and low-side power MOSFETs (HS-FET and LS-FET, respectively). It provides 5A of highly efficient output with current mode control.

The device features a wide input voltage range, configurable switching frequency, external soft start, and precision current limiting. Its very low operational quiescent current makes it ideal for battery-powered applications.

### Pulse-Width Modulation (PWM) Control

At moderate to high output currents, the MP4315 operates in fixed-frequency, peak current control mode to regulate the output voltage ( $V_{OUT}$ ). A pulse-width modulation (PWM) cycle is initiated by the internal clock. At the rising edge of the clock, the HS-FET turns on and remains on until its current reaches the value set by the internal COMP voltage ( $V_{COMP}$ ). Once the HS-FET is on, it remains on for at least 100ns.

When the HS-FET turns off, the LS-FET turns on immediately and remains on until the next cycle starts. Once the LS-FET is on, it remains on for at least 80ns before the next cycle starts.

If the HS-FET current does not reach the current value set by COMP within one PWM period, then the HS-FET remains on, saving a turn-off operation. If the on time lasts longer than 10 $\mu$ s even though the COMP current is not reached, the HS-FET is forced off.

### Light-Load Operation

Under light-load conditions, the MP4315 can operate in two different modes by setting the MODE pin to a different status (see Figure 3).

When the MODE pin is pulled above 1.8V, the MP4315 works in forced continuous conduction mode (FCCM). The device works with a fixed frequency across the no-load to full-load range in this mode. FCCM offers the advantages of a controllable frequency and lower output ripple at light loads.

When the MODE pin is below 0.4V, the MP4315 works in advanced asynchronous mode (AAM). AAM optimizes efficiency during light-load and no-load conditions.

When AAM is enabled, the MP4315 first enters non-synchronous operation as long as the inductor current ( $I_L$ ) approaches 0A at light loads. If the load is further decreased or there is no load,  $V_{COMP}$  decreases to the set value, and the MP4315 enters AAM. In AAM, the internal clock is reset every time  $V_{COMP}$  crosses the set value. The crossover time is used as a benchmark for the next clock. When the load increases and  $V_{COMP}$  exceeds the set value, the MP4315 operates in discontinuous conduction mode (DCM) or FCCM, which both have a constant switching frequency.

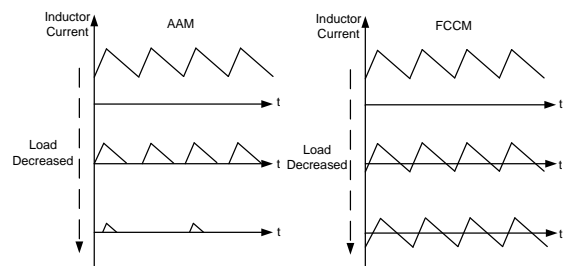

**Figure 3: AAM vs. FCCM**

### Error Amplifier (EA)

The error amplifier (EA) compares the voltage on the FB pin ( $V_{FB}$ ) with the internal reference voltage ( $V_{REF}$ , about 0.815V) and outputs a current proportional to the difference between the two. This output current is then used to charge the compensation network to form  $V_{COMP}$ , which controls the power MOSFET current.

During operation, the minimum  $V_{COMP}$  is clamped to 0.9V and its maximum is clamped to 2.0V. COMP is internally pulled down to GND when the device shuts down.

### Internal VCC Regulator

Most of the internal circuitry is powered by the internal, 4.9V VCC regulator. This regulator uses  $V_{IN}$  as input and operates in the full  $V_{IN}$  range. When  $V_{IN}$  exceeds 4.9V, the VCC voltage ( $V_{CC}$ ) is in full regulation. When  $V_{IN}$  is below 4.9V, the  $V_{CC}$  output drops.

### Bootstrap Charging

The bootstrap capacitor ( $C_{BST}$ ) is charged and regulated to about 5V by the dedicated internal bootstrap regulator. When the voltage between the BST and SW nodes is lower than its regulation, a P-channel MOSFET pass transistor



connected from VCC to BST turns on to charge C<sub>BST</sub>. Any external circuitry should provide enough voltage headroom to facilitate charging. When the HS-FET is on, the bootstrap voltage (V<sub>BST</sub>) is above V<sub>CC</sub>, so C<sub>BST</sub> cannot be charged.

At higher duty cycles, the time period available for bootstrap charging is shorter, so C<sub>BST</sub> may not charge sufficiently. If the external circuit does not have sufficient voltage and time to charge C<sub>BST</sub>, extra external circuitry can be used to ensure that V<sub>BST</sub> is within the normal operation range.

### Low-Dropout Mode and BST Refresh

To improve dropout, the MP4315 is designed to operate at close to 100% duty cycle as long as the voltage from BST to SW is above 2.5V. When the BST-to-SW voltage drops below 2.5V, the HS-FET turns off using a UVLO circuit, which allows the LS-FET to conduct and refresh the charge on C<sub>BST</sub>. In DCM or pulse-skip mode (PSM), the LS-FET is forced on to refresh V<sub>BST</sub>.

Since the supply current sourced from C<sub>BST</sub> is low, the HS-FET can remain on for more switching cycles than are required to refresh the capacitor. Therefore, the effective duty cycle of the switching regulator is high.

The effective duty cycle during regulator dropout is mainly influenced by the voltage drop across the power MOSFET, the inductor resistance, the low-side diode, and the PCB resistance.

### Enable (EN) Control

EN is a digital control pin that turns the regulator on and off. The MP4315 can be enabled in two ways:

1. Enable the IC with the external logic H/L signal. When EN is pulled below its falling threshold voltage (0.85V), the chip goes into the lowest shutdown current mode. Force this pin above the EN rising threshold voltage (1V) to turn on the part.
2. Enable the IC with the configurable V<sub>IN</sub> under-voltage lockout (UVLO) threshold. With a sufficiently high input voltage (V<sub>IN</sub>), the chip can be enabled and disabled by the EN pin. With the internal current source, this circuit can generate a configurable V<sub>IN</sub> UVLO and hysteresis (see Figure 4).

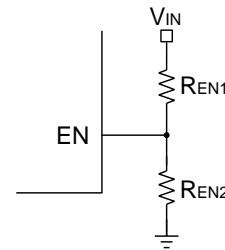

**Figure 4: EN Divider Circuit**

### Configurable Frequency and Foldback

The MP4315 oscillating frequency can be configured by an external resistor (R<sub>FREQ</sub>) connected from the FREQ pin to ground, or by a logic-level SYNC signal.

To set the switching frequency (f<sub>SW</sub>), select the R<sub>FREQ</sub> value following the f<sub>SW</sub> vs. R<sub>FREQ</sub> curve in the Typical Performance Characteristics section on page 13. Note that f<sub>SW</sub> will fold back at a high V<sub>IN</sub> values to avoid the minimum on time being triggered, which can force the output out of regulation. The f<sub>SW</sub> vs. V<sub>IN</sub> curve in Typical Performance Characteristics section on page 13 shows an example in which R<sub>FREQ</sub> is 12kΩ. The corresponding f<sub>SW</sub> is about 2.1MHz at V<sub>IN</sub> = 12V, and drops to below 1.5MHz when V<sub>IN</sub> > 18V. f<sub>SW</sub> then drops into the AM band (<1.8MHz), which should be avoided for car battery applications due to EMC requirements. The recommended f<sub>SW</sub> range for car battery applications is 350kHz to 1000kHz. Table 1 lists recommended R<sub>FREQ</sub> values for common frequencies. Higher frequencies may be supported for applications that do not have a critical f<sub>SW</sub> limit or have a relatively low, stable V<sub>IN</sub>.

**Table 1: Resistor Selection for Frequency**

R <sub>FREQ</sub> (kΩ)	f <sub>SW</sub> (kHz)
86.6	350
80.6	380
75	410
62	470
59	500
54.9	530
49.9	590
45.3	640
41.2	700
37.4	760
34	830
30.9	910
28.7	960
26.1	1000

### Frequency Spread Spectrum (FSS)

The MP4315 uses a 12kHz modulation frequency with a 128-step triangular profile to spread the internal oscillator frequency across a 20% ( $\pm 10\%$ ) window. The steps are fixed and independent of the setting oscillator frequency to optimize the frequency spread spectrum (FSS) performance.

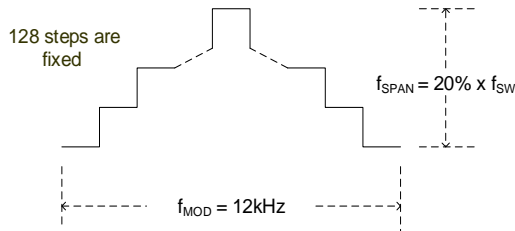

**Figure 5: Spread Spectrum Scheme**

Side bands are created by modulating the switching frequency with the triangle modulation waveform. The emission power of the fundamental switching frequency and its harmonics are reduced. Thus, the peak EMI noise is significantly reduced.

### Soft Start (SS)

Soft start (SS) is implemented to prevent  $V_{OUT}$  from overshooting during start-up. When soft start begins, an internal current source begins charging the external soft-start capacitor ( $C_{SS}$ ). When the soft-start voltage ( $V_{SS}$ ) is below  $V_{REF}$ ,  $V_{SS}$  overrides  $V_{REF}$  and the EA uses  $V_{SS}$  as the reference. When  $V_{SS}$  exceeds  $V_{REF}$ , the EA uses  $V_{REF}$  as the reference.

$C_{SS}$  can be calculated with Equation (1):

$$C_{SS}(\text{nF}) = \frac{t_{SS}(\text{ms}) \times I_{SS}(\mu\text{A})}{V_{REF}(\text{V})} = 6.25 \times t_{SS}(\text{ms}) \quad (1)$$

The SS pins can be used for tracking and sequencing.

### Pre-Biased Start-Up

If  $V_{FB} > V_{SS} - 150\text{mV}$  at start-up, the output has a pre-biased voltage, and neither the HS-FET nor LS-FET turn on until  $V_{SS}$  exceeds  $V_{FB}$ .

### Thermal Shutdown (TSD)

Thermal shutdown (TSD) is implemented to protect the MP4315 from thermal runaway. When the silicon die temperature exceeds its upper threshold, the power MOSFETs shut down. When the temperature falls back below this threshold, the MP4315 starts up and resumes

normal operation.

### Current Comparator and Current Limit

The power MOSFET current is accurately sensed via a current-sense MOSFET, then fed to the high-speed current comparator for current mode control. The current comparator uses this sensed current as one of its inputs. When the HS-FET is on, the comparator is blanked until the end of the turn-on transition to avoid noise. Then the comparator compares the MOSFET current with  $V_{COMP}$ . When the sensed current exceeds  $V_{COMP}$ , the comparator outputs low to turn off the HS-FET. The internal power MOSFET's maximum current is internally limited cycle by cycle.

### Hiccup Protection

When the output is shorted to ground, causing  $V_{OUT}$  to drop below 70% of its nominal output, the MP4315 shuts down momentarily and discharges  $C_{SS}$ . Once the soft-start capacitor is fully discharged, the IC restarts with a full soft start. This hiccup process repeats until the fault is removed.

### Start-Up and Shutdown

If  $V_{IN}$  and  $EN$  exceeds their respective thresholds, the chip starts. The reference block starts first, generating a stable reference voltage and currents; then the internal regulator is enabled. The regulator provides a stable supply for the remaining circuitries.

While the internal supply rail is up, an internal timer keeps the power MOSFET off for about 50 $\mu\text{s}$  to blank the start-up glitches. When the soft start block is enabled, the SS output is held low to ensure the remaining circuitries are ready, then the output slowly ramps up.

Three events can shut down the chip:  $EN$  going low,  $V_{IN}$  going low, and thermal shutdown. During the shutdown procedure, the signaling path is blocked first to avoid any fault triggering.  $V_{COMP}$  and the internal supply rail are then pulled down. The floating driver is not subject to this shutdown command, but its charging path is disabled.

### Power Good (PG) Output

The MP4315 includes an open-drain power good (PG) output that indicates whether  $V_{OUT}$  is within its normal range. Connect this pin to a high-voltage source, such as  $V_{CC}$ , when used.

PG goes high if  $V_{OUT}$  is within 93% to 106% of the nominal voltage, and goes low when  $V_{OUT}$  is above 107.5% or below 91% of the nominal voltage.

### **SYNCIN and SYNCO**

$f_{SW}$  can be synced to the rising edge of the clock signal applied at the SYNCIN pin. The recommended SYNCIN frequency range is 350kHz to 1000kHz. The SYNCIN off time should be shorter than the internal oscillator period, or the internal clock could turn on the HS-FET before SYNCIN's rising edge. There are no other limits on the pulse width of SYNCIN; however, there is always parasitic capacitance on the pad there; if the pulse width is too short, a clear rising and falling edge may not be seen due to the parasitic capacitance. A pulse longer than 100ns is recommended in application.

When applying SYNCIN in AAM, drive SYNCIN below its specified threshold (0.4V) or leave SYNCIN floating before the MP4315 starts up to enter AAM. Then add the external SYNCIN clock. To avoid SYNCIN floating when using this function through an external clock, connect a resistor to GND. Given SYNCIN's drive capability, the resistor is recommended to be between 10k $\Omega$  and 51k $\Omega$ .

The SYNCO pin provides a default 180° phase-shifted clock from the internal oscillator. If there is no external SYNCIN clock, SYNCO can provide a 180° phase shift clock compared with the internal clock. If there is an external SYNCIN clock, SYNCO provides a 180° phase shift clock compared with the external SYNCIN clock. This enables the user to easily implement a dual-phase interleaved configuration.

## APPLICATION INFORMATION

### Setting the Output Voltage

The external resistor divider connected to FB sets the output voltage (see Figure 6).

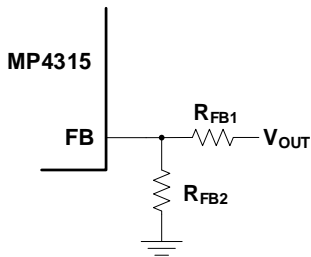

**Figure 6: Feedback Network**

Calculate R<sub>FB2</sub> with Equation (2):

$$R_{FB2} = \frac{R_{FB1}}{\frac{V_{OUT}}{0.815V} - 1} \quad (2)$$

Table 2 lists the recommended feedback resistor values for common output voltages.

**Table 2: Recommended Resistors for Output Voltages**

V <sub>OUT</sub> (V)	R <sub>FB1</sub> (kΩ)	R <sub>FB2</sub> (kΩ)
3.3	100 (1%)	32.4 (1%)
5	100 (1%)	19.6 (1%)

### Selecting the Input Capacitor

The converter has a discontinuous input current, and requires a capacitor to supply AC current to the converter while maintaining the DC input voltage. For the best performance, use low-ESR capacitors. Ceramic capacitors with X5R or X7R dielectrics are highly recommended because of their low ESR and small temperature coefficients. For most applications, it is recommended to use a 4.7μF to 10μF capacitor. It is strongly recommended to use another, lower-value capacitor (e.g. 0.1μF) with a small package size (0603) to absorb high-frequency switching noise. Place the smaller capacitor as close to V<sub>IN</sub> and GND as possible.

Since the input capacitor (C<sub>IN</sub>) absorbs the input switching current, it requires an adequate ripple current rating. Estimate the RMS current in C<sub>IN</sub> with Equation (3):

$$I_{CIN} = I_{LOAD} \times \sqrt{\frac{V_{OUT}}{V_{IN}} \times \left(1 - \frac{V_{OUT}}{V_{IN}}\right)} \quad (3)$$

The worst-case condition occurs at V<sub>IN</sub> = 2 × V<sub>OUT</sub>, calculated with Equation (4):

$$I_{CIN} = \frac{I_{LOAD}}{2} \quad (4)$$

For simplification, choose an input capacitor with an RMS current rating greater than half of the maximum load current.

C<sub>IN</sub> can be electrolytic, tantalum, or ceramic. When using electrolytic or tantalum capacitors, add a small, high-quality ceramic capacitor (e.g. 0.1μF) as close to the IC as possible. When using ceramic capacitors, ensure that they have enough capacitance to provide a sufficient charge to prevent excessive voltage ripple at the input. The input voltage ripple caused by the capacitance can be estimated with Equation (5):

$$\Delta V_{IN} = \frac{I_{LOAD}}{f_{SW} \times C_{IN}} \times \frac{V_{OUT}}{V_{IN}} \times \left(1 - \frac{V_{OUT}}{V_{IN}}\right) \quad (5)$$

### Selecting the Output Capacitor

The output capacitor (C<sub>OUT</sub>) maintains the DC output voltage. Use ceramic, tantalum, or low-ESR electrolytic capacitors. For the best results, use low-ESR capacitors to keep the output voltage ripple low. The output voltage ripple can be estimated with Equation (6):

$$\Delta V_{OUT} = \frac{V_{OUT}}{f_{SW} \times L} \times \left(1 - \frac{V_{OUT}}{V_{IN}}\right) \times \left(R_{ESR} + \frac{1}{8f_{SW} \times C_{OUT}}\right) \quad (6)$$

Where L is the inductor value, and R<sub>ESR</sub> is the equivalent series resistance (ESR) value of the output capacitor.

For ceramic capacitors, the capacitance dominates the impedance at the switching frequency and causes the majority of the output voltage ripple. For simplification, the output voltage ripple can be estimated with Equation (7):

$$\Delta V_{OUT} = \frac{V_{OUT}}{8 \times f_{SW}^2 \times L \times C_{OUT}} \times \left(1 - \frac{V_{OUT}}{V_{IN}}\right) \quad (7)$$

For tantalum or electrolytic capacitors, the ESR dominates the impedance at the switching frequency.

For simplification, the output voltage ripple can be estimated with Equation (8):

$$\Delta V_{OUT} = \frac{V_{OUT}}{f_{SW} \times L} \times \left(1 - \frac{V_{OUT}}{V_{IN}}\right) \times R_{ESR} \quad (8)$$

The characteristics of the output capacitor also affect the stability of the regulation system. The MP4315 can be optimized for a wide range of capacitance and ESR values.

### Selecting the Inductor

A 1μH to 10μH inductor with a DC current rating at least 25% greater than the maximum load current is recommended for most applications. For higher efficiency, choose an inductor with a lower DC resistance. A larger-value inductor results in less ripple current and a lower output ripple voltage; however, it also has a larger physical size, higher series resistance, and lower saturation current. A good rule for determining the inductor value is to allow the inductor ripple current to be approximately 30% of the maximum load current. The inductance (L) can then be calculated with Equation (9):

$$L = \frac{V_{OUT}}{f_{SW} \times \Delta I_L} \times \left(1 - \frac{V_{OUT}}{V_{IN}}\right) \quad (9)$$

Where  $\Delta I_L$  is the peak-to-peak inductor ripple current.

Choose the inductor ripple current to be approximately 30% of the maximum load current. The maximum peak inductor current ( $I_{LP}$ ) can be calculated with Equation (10):

$$I_{LP} = I_{LOAD} + \frac{V_{OUT}}{2f_{SW} \times L} \times \left(1 - \frac{V_{OUT}}{V_{IN}}\right) \quad (10)$$

### V<sub>IN</sub> Under-Voltage Lockout (UVLO) Setting

The MP4315 has an internal fixed under-voltage lockout (UVLO) threshold. The rising threshold is 3V, and the falling threshold is about 2.65V. For applications that require a higher UVLO point, an external resistor divider can be placed between V<sub>IN</sub> and EN to achieve a higher equivalent UVLO threshold (see Figure 7).

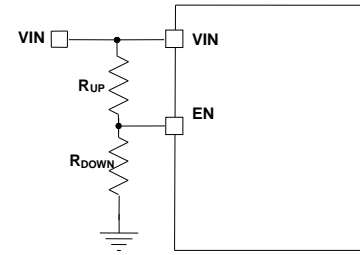

**Figure 7: Adjustable UVLO Using EN Divider**

The UVLO rising and falling thresholds can be calculated with Equation (11) and Equation (12), respectively:

$$INUV_{RISING} = \left(1 + \frac{R_{UP}}{R_{DOWN}}\right) \times V_{EN\_RISING} \quad (11)$$

$$INUV_{FALLING} = \left(1 + \frac{R_{UP}}{R_{DOWN}}\right) \times V_{EN\_FALLING} \quad (12)$$

Where  $V_{EN\_RISING}$  is 1V, and  $V_{EN\_FALLING}$  is 0.85V.

### External BST Diode and Resistor

An external BST diode can enhance the efficiency of the regulator when the duty cycle is high. A power supply between 2.5V and 5V can be used to power the external bootstrap diode. It is recommended for V<sub>CC</sub> or V<sub>OUT</sub> to be this power supply in the circuit (see Figure 8).

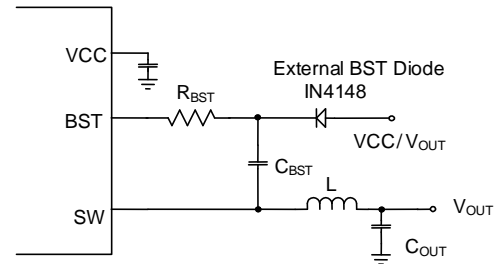

**Figure 8: Optional External Bootstrap Diode to Enhance Efficiency**

The recommended external BST diode is IN4148, and the recommended BST capacitance is between 0.1μF and 1μF. Place a resistor ( $R_{BST}$ ) in series with  $C_{BST}$  to reduce the SW rising rate and voltage spikes. This improves EMI performance and reduces voltage stress at a high V<sub>IN</sub>. A higher resistance is better for SW spike reduction, but compromises efficiency. To make an appropriate tradeoff between EMI and efficiency, a  $\leq 20\Omega$   $R_{BST}$  is recommended.

### Setting the VCC Capacitor

The VCC capacitor should be 10 times greater than the boost capacitor. A VCC capacitor above 68μF is not recommended.



**PCB Layout Guidelines** <sup>(10)</sup>

Efficient PCB layout, especially input capacitor placement, is critical for stable operation. A 4-layer layout is strongly recommended to improve thermal performance. For the best results, refer to Figure 9 and follow the guidelines below:

1. Place symmetric input capacitors as close as possible to the VIN and GND pins.
2. Connect a large copper ground plane directly to PGND.
3. Add vias near PGND if the bottom layer is a ground plane.
4. Ensure that the high-current paths at GND and VIN have short, direct, and wide traces.
5. Place the ceramic input capacitor, especially the small package size (0603) input bypass capacitor, as close to VIN and PGND as possible to minimize high-frequency noise.
6. Keep the connection of the input capacitor and VIN as short and wide as possible.
7. Place the VCC capacitor as close as possible to the VCC and GND pins.
8. Route SW and BST away from sensitive analog areas, such as FB.
9. Place the feedback resistors close to the IC to keep the trace that connects to FB as short as possible.
10. Use multiple vias to connect the power planes to the internal layers.

**Note:**

10) The recommended PCB layout is based on Figure 10 on page 31.

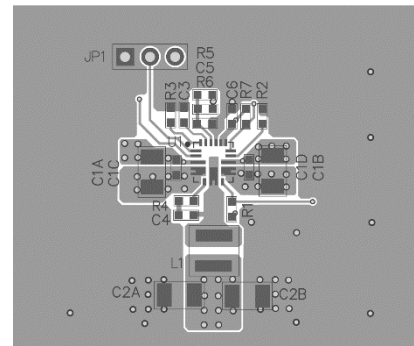
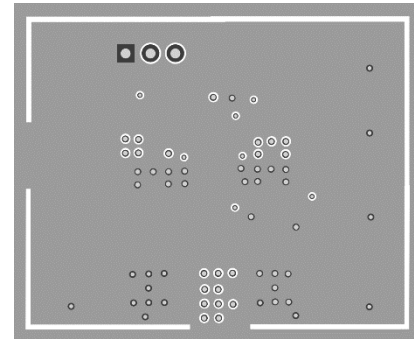
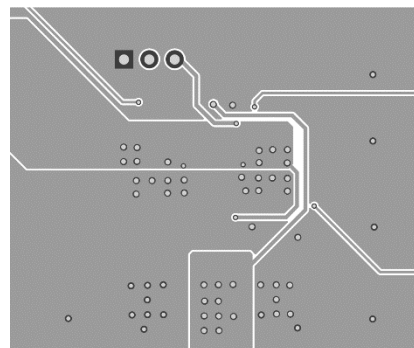
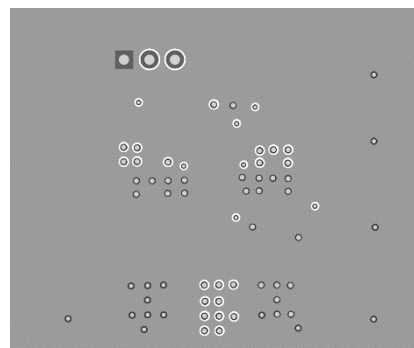
**Top Layer**

**Mid-Layer 1**

**Mid-Layer 2**

**Bottom Layer**
**Figure 9: Recommended PCB Layout**

## TYPICAL APPLICATION CIRCUITS

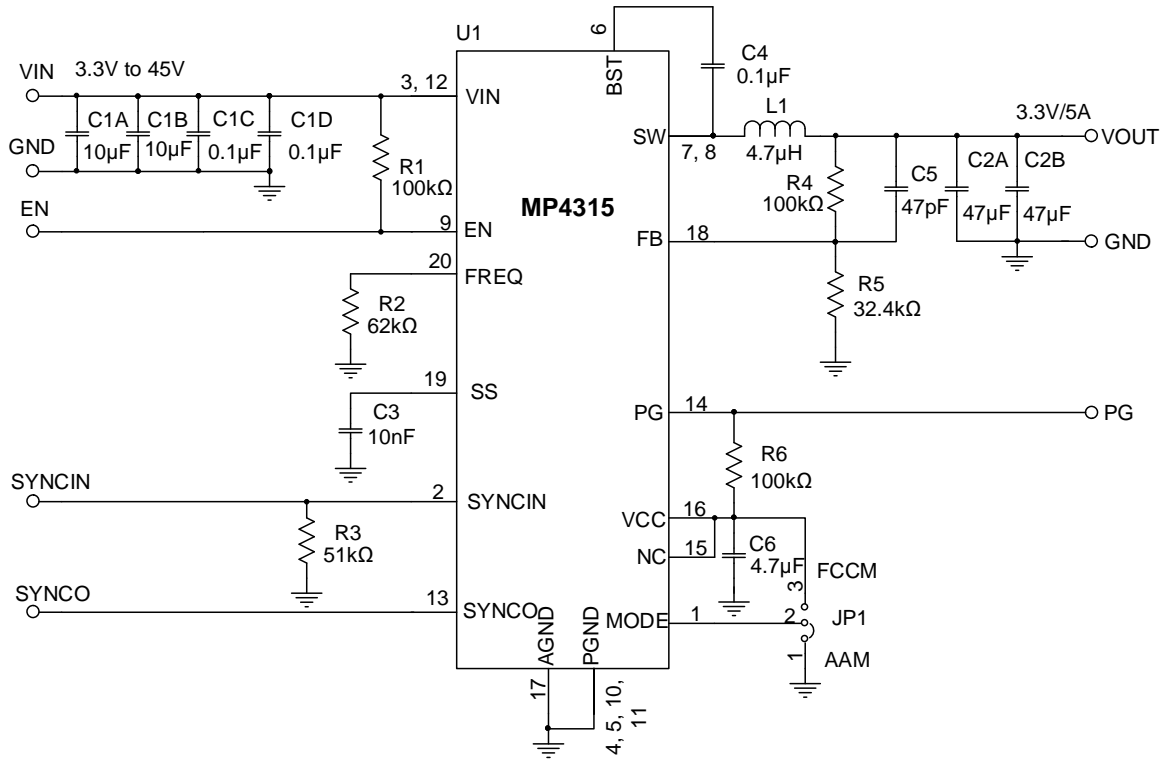

Figure 10: Typical Application Circuit ( $V_{OUT} = 3.3V$ ,  $f_{sw} = 470kHz$ )

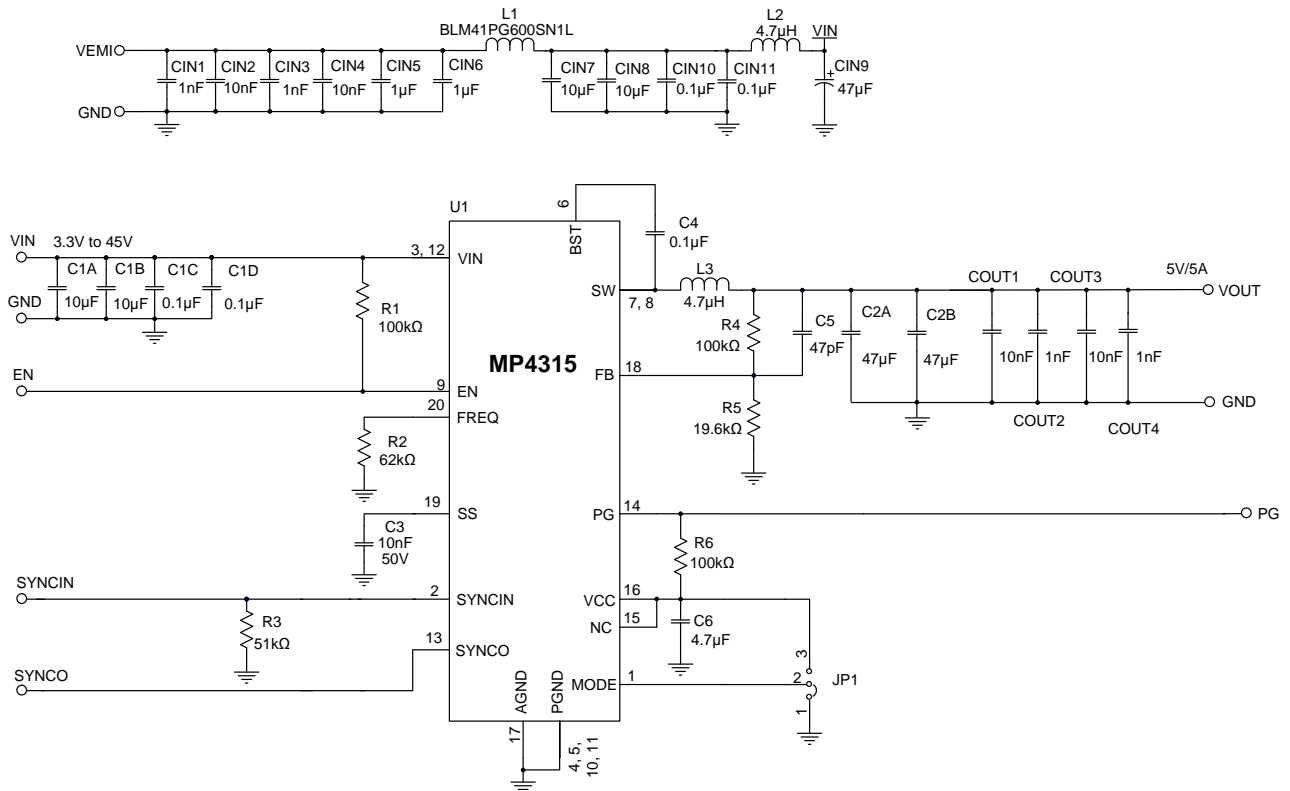
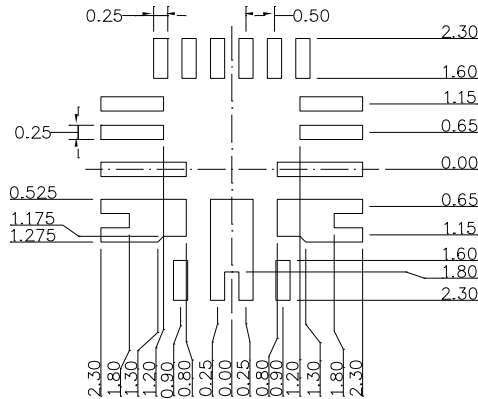
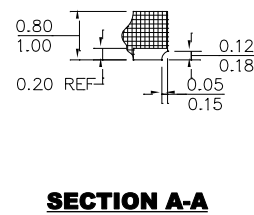
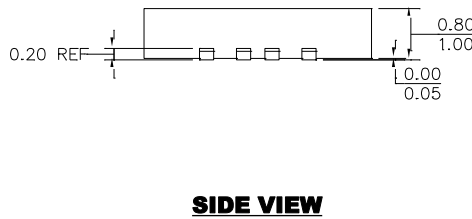
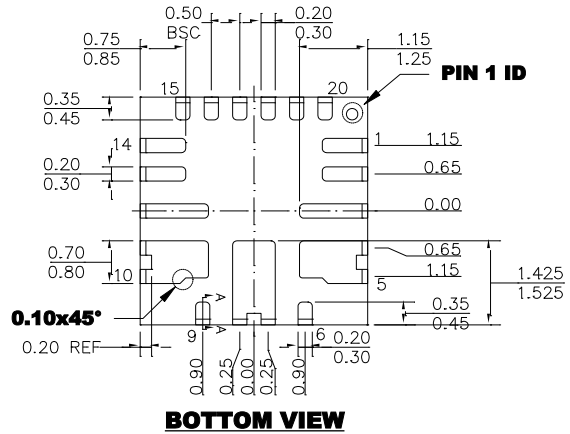
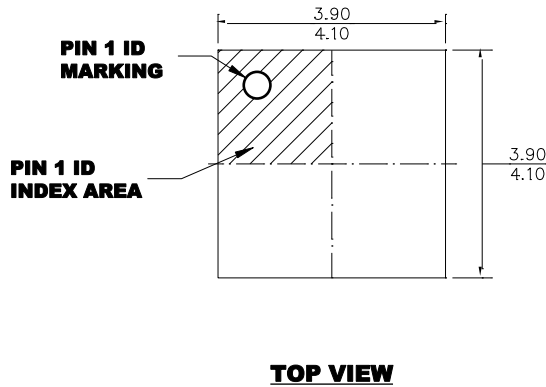

Figure 11: Typical Application Circuit ( $V_{OUT} = 5V$ ,  $f_{sw} = 470kHz$  with EMI Filters)

## PACKAGE INFORMATION

### QFN-20 (4mmx4mm) Wettable Flank



#### **NOTE:**

- 1) THE LEAD SIDE IS WETTABLE.
- 2) ALL DIMENSIONS ARE IN MILLIMETERS.
- 3) LEAD COPLANARITY SHALL BE 0.08 MILLIMETERS MAX.
- 4) JEDEC REFERENCE IS MO-220.
- 5) DRAWING IS NOT TO SCALE.



### CARRIER INFORMATION

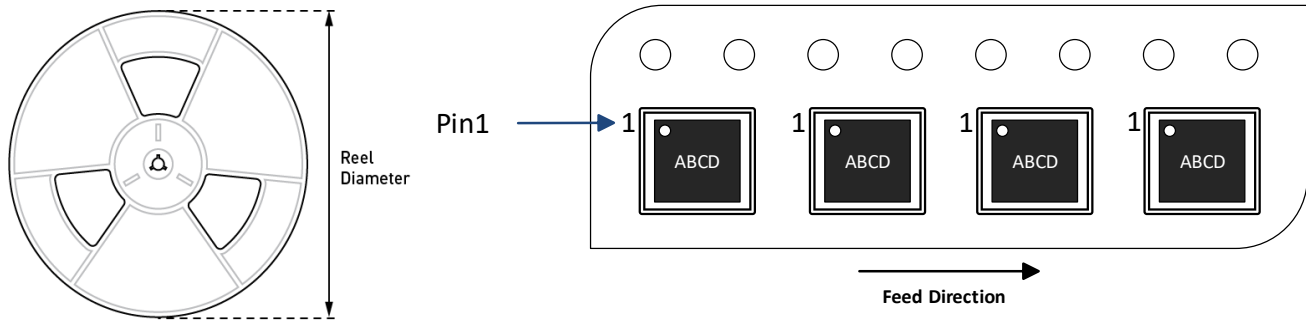

Part Number	Package Description	Quantity/ Reel	Quantity/ Tube <sup>(11)</sup>	Reel Diameter	Carrier Tape Width	Carrier Tape Pitch
MP4315GRE-Z	QFN-20 (4mmx4mm)	5000	N/A	13in	12mm	8mm

**Note:**

11) N/A indicates "not available" in tubes. For 500-piece tape & reel prototype quantities, contact the factory. (The order code for 500 pieces partial reel is "-P", and tape & reel dimensions are the same as for the full reel.)



## REVISION HISTORY

Revision #	Revision Date	Description	Pages Updated
1.0	07/22/2021	Initial Release	-

**Notice:** The information in this document is subject to change without notice. Please contact MPS for current specifications. Users should warrant and guarantee that third-party Intellectual Property rights are not infringed upon when integrating MPS products into any application. MPS will not assume any legal responsibility for any said applications.