



# HiPerFRED

$V_{RRM}$	=	<b>300 V</b>
$I_{FAV}$	=	<b>10 A</b>
$t_{rr}$	=	<b>35 ns</b>

High Performance Fast Recovery Diode  
 Low Loss and Soft Recovery  
 Single Diode

**Part number**

**DPG10IM300UC**

Marking on Product: PAOGUI

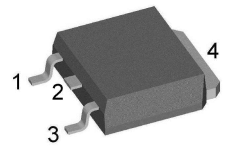

Backside: cathode

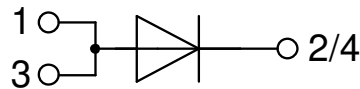

**Features / Advantages:**

- Planar passivated chips
- Very low leakage current
- Very short recovery time
- Improved thermal behaviour
- Very low I<sub>rm</sub>-values
- Very soft recovery behaviour
- Avalanche voltage rated for reliable operation
- Soft reverse recovery for low EMI/RFI
- Low I<sub>rm</sub> reduces:
  - Power dissipation within the diode
  - Turn-on loss in the commutating switch

**Applications:**

- Antiparallel diode for high frequency switching devices
- Antisaturation diode
- Snubber diode
- Free wheeling diode
- Rectifiers in switch mode power supplies (SMPS)
- Uninterruptible power supplies (UPS)

**Package:** TO-252 (DPak)

- Industry standard outline
- RoHS compliant
- Epoxy meets UL 94V-0

**Disclaimer Notice**

Information furnished is believed to be accurate and reliable. However, users should independently evaluate the suitability of and test each product selected for their own applications. Littelfuse products are not designed for, and may not be used in, all applications. Read complete Disclaimer Notice at [www.littelfuse.com/disclaimer-electronics](http://www.littelfuse.com/disclaimer-electronics).



Fast Diode				Ratings			
Symbol	Definition	Conditions	min.	typ.	max.	Unit	
$V_{RSM}$	max. non-repetitive reverse blocking voltage	$T_{VJ} = 25^{\circ}C$			300	V	
$V_{RRM}$	max. repetitive reverse blocking voltage	$T_{VJ} = 25^{\circ}C$			300	V	
$I_R$	reverse current, drain current	$V_R = 300 V$	$T_{VJ} = 25^{\circ}C$		1	$\mu A$	
		$V_R = 300 V$	$T_{VJ} = 150^{\circ}C$		0.06	mA	
$V_F$	forward voltage drop	$I_F = 10 A$	$T_{VJ} = 25^{\circ}C$		1.27	V	
		$I_F = 20 A$			1.45	V	
		$I_F = 10 A$	$T_{VJ} = 150^{\circ}C$		0.98	V	
		$I_F = 20 A$			1.17	V	
$I_{FAV}$	average forward current	$T_C = 150^{\circ}C$ rectangular $d = 0.5$	$T_{VJ} = 175^{\circ}C$		10	A	
$V_{FO}$	threshold voltage	} for power loss calculation only	$T_{VJ} = 175^{\circ}C$		0.74	V	
$r_F$	slope resistance				17.7	m $\Omega$	
$R_{thJC}$	thermal resistance junction to case				2.3	K/W	
$R_{thCH}$	thermal resistance case to heatsink			0.5		K/W	
$P_{tot}$	total power dissipation		$T_C = 25^{\circ}C$		65	W	
$I_{FSM}$	max. forward surge current	$t = 10 ms; (50 Hz), sine; V_R = 0 V$	$T_{VJ} = 45^{\circ}C$		140	A	
$C_J$	junction capacitance	$V_R = 150 V f = 1 MHz$	$T_{VJ} = 25^{\circ}C$		15	pF	
$I_{RM}$	max. reverse recovery current	} $I_F = 10 A; V_R = 200 V$ $-di_F / dt = 200 A/\mu s$	$T_{VJ} = 25^{\circ}C$		3	A	
			$T_{VJ} = 125^{\circ}C$		5.5	A	
$t_{rr}$	reverse recovery time		$T_{VJ} = 25^{\circ}C$		35	ns	
			$T_{VJ} = 125^{\circ}C$		45	ns	



Package TO-252 (DPak)			Ratings			
Symbol	Definition	Conditions	min.	typ.	max.	Unit
$I_{RMS}$	RMS current	per terminal <sup>1)</sup>			20	A
$T_{VJ}$	virtual junction temperature		-55		175	°C
$T_{op}$	operation temperature		-55		150	°C
$T_{stg}$	storage temperature		-55		150	°C
<b>Weight</b>				0.3		g
$F_C$	mounting force with clip		20		60	N

<sup>1)</sup>  $I_{RMS}$  is typically limited by the pin-to-chip resistance (1); or by the current capability of the chip (2). In case of (1) and a product with multiple pins for one chip-potential, the current capability can be increased by connecting the pins as one contact.

**Product Marking**

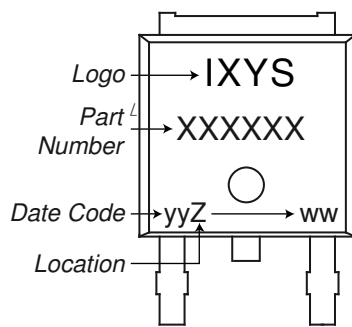

**Part description**

- D = Diode
- P = HiPerFRED
- G = extreme fast
- 10 = Current Rating [A]
- IM = Single Diode
- 300 = Reverse Voltage [V]
- UC = TO-252AA (DPak)

Ordering	Ordering Number	Marking on Product	Delivery Mode	Quantity	Code No.
Standard	DPG10IM300UC-TRL	PAOGUI	Tape & Reel	2500	505682
Alternative	DPG10IM300UC-TUB	PAOGUI	Tube	70	524908

Similar Part	Package	Voltage class
DPG10I300PA	TO-220AC (2)	300

**Equivalent Circuits for Simulation**

*\* on die level*

$T_{VJ} = 175^{\circ}C$

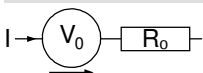

Symbol	Definition	Value	Unit
$V_{0\ max}$	threshold voltage	0.74	V
$R_{0\ max}$	slope resistance *	14.5	mΩ



**Outlines TO-252 (DPak)**

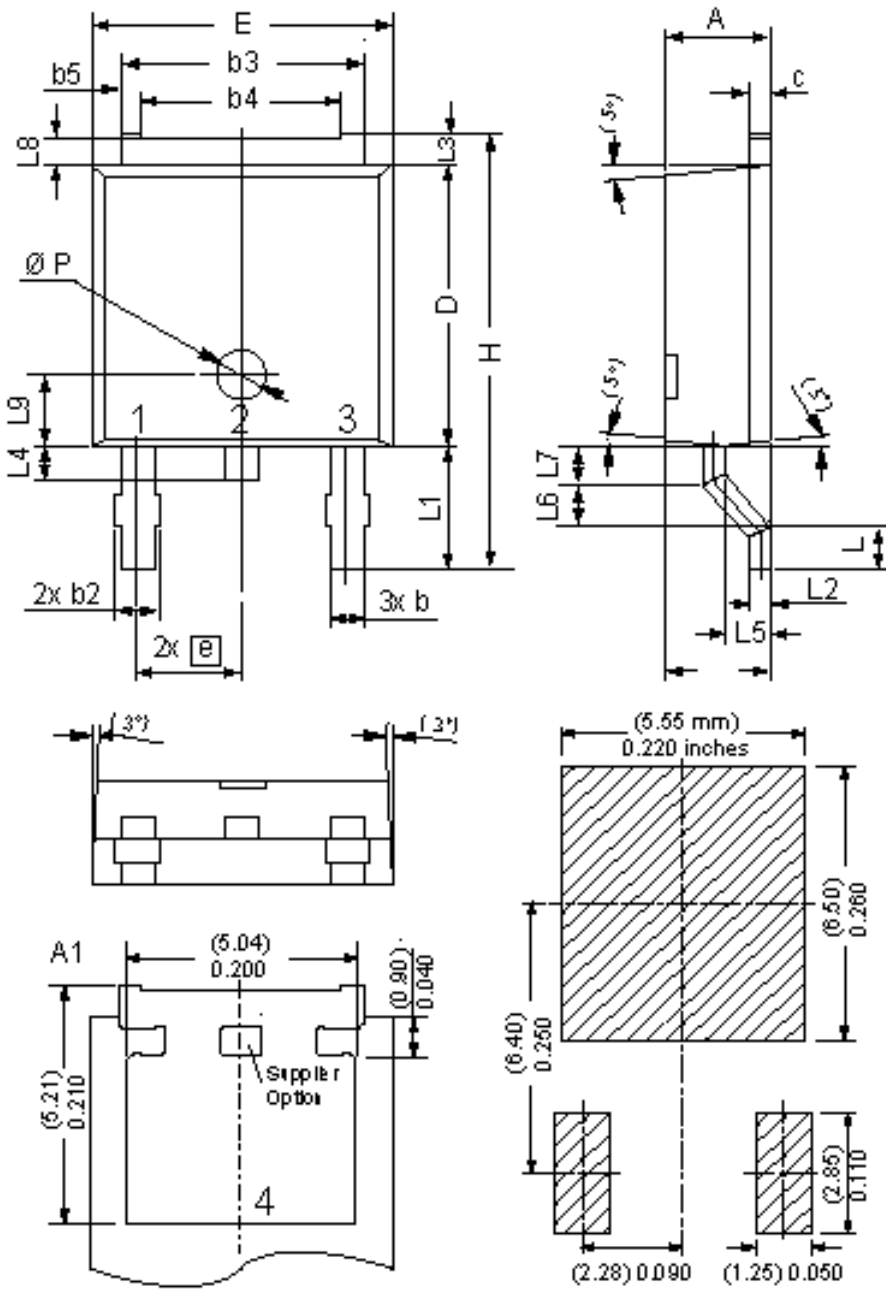

Dim	Millimeters		Inches	
	min	max	min	max
A	2.20	2.40	0.087	0.094
A1	2.10	2.50	0.083	0.098
b	0.66	0.86	0.026	0.034
b2	-	0.96	-	0.038
b3	5.04	5.64	0.198	0.222
b4	4.34	BSC	0.171	BSC
b5	0.50	BSC	0.020	BSC
c	0.40	0.86	0.016	0.034
D	5.90	6.30	0.232	0.248
E	6.40	6.80	0.252	0.268
e	2.10	2.50	0.083	0.098
H	9.20	10.10	0.362	0.398
L	0.55	1.28	0.022	0.050
L1	2.50	2.90	0.098	0.114
L2	0.40	0.60	0.016	0.024
L3	0.50	0.90	0.020	0.035
L4	0.60	1.00	0.024	0.039
L5	0.82	1.22	0.032	0.048
L6	0.79	0.99	0.031	0.039
L7	0.81	1.01	0.032	0.040
L8	0.40	0.80	0.016	0.031
L9	1.50	BSC	0.059	BSC
Ø P	1.00	BSC	0.039	BSC

Recommended  
min. footprint

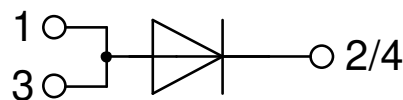

**Fast Diode**

 Fig. 1 Forward current  $I_F$  versus  $V_F$ 

 Fig. 2 Typ. reverse recov. charge  $Q_{rr}$  versus  $-di_F/dt$ 

 Fig. 3 Typ. reverse recov. current  $I_{RR}$  versus  $-di_F/dt$ 

 Fig. 4 Typ. dynamic parameters  $Q_{rr}$ ,  $I_{RR}$  versus  $T_{VJ}$ 

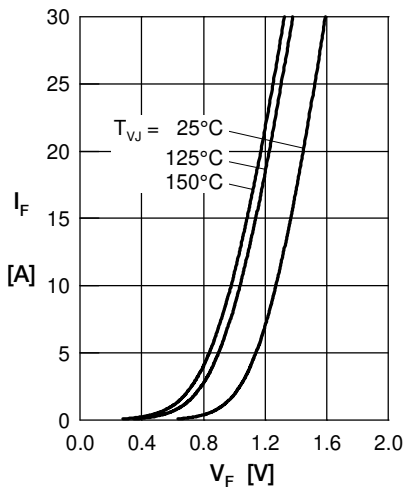
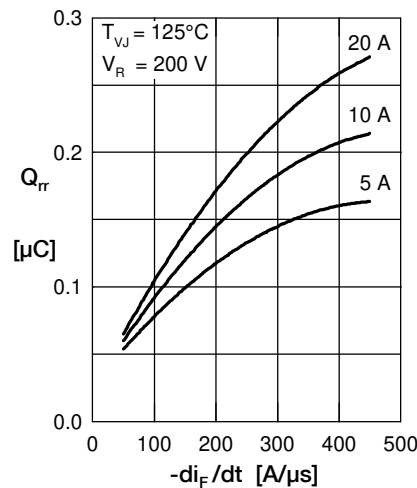
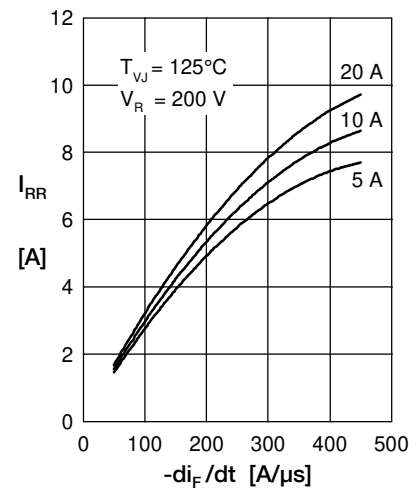
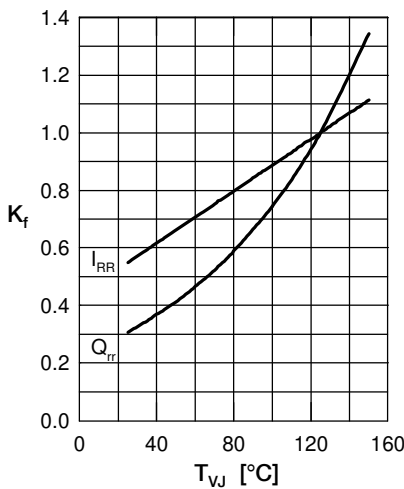
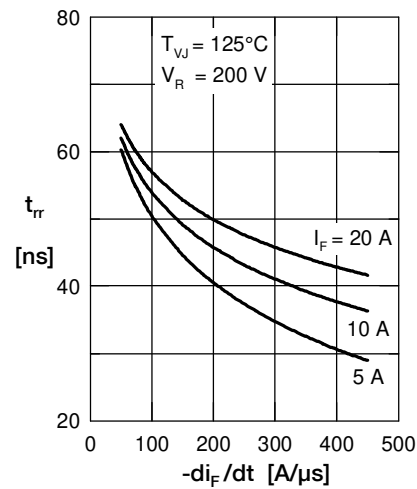
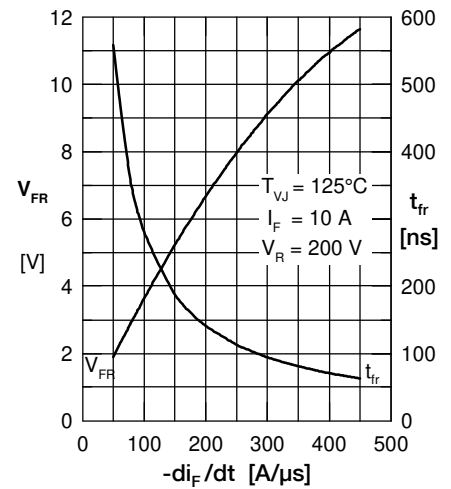
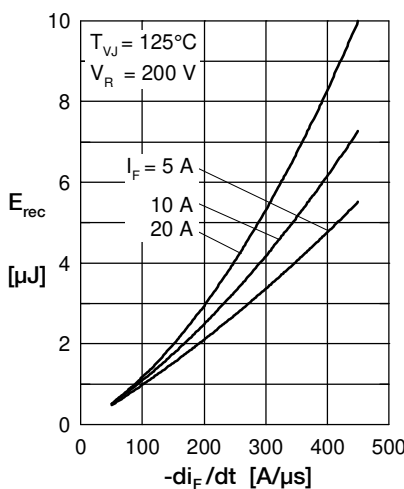
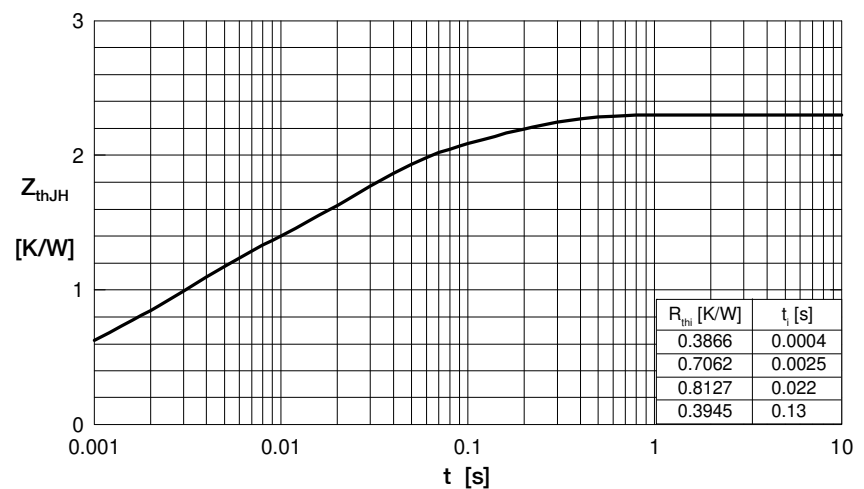
 Fig. 5 Typ. reverse recov. time  $t_{rr}$  versus  $-di_F/dt$ 

 Fig. 6 Typ. forward recov. voltage  $V_{FR}$  and  $t_{fr}$  versus  $di_F/dt$ 

 Fig. 7 Typ. recovery energy  $E_{rec}$  versus  $-di_F/dt$ 

Fig. 8 Transient thermal resistance junction to case