

SN54AHC123A, SN74AHC123A DUAL RETRIGGERABLE MONOSTABLE MULTIVIBRATORS

SCLS352H – JULY 1997 – REVISED OCTOBER 2005

- Operating Range 2-V to 5.5-V V_{CC}
- Schmitt-Trigger Circuitry On \overline{A} , B, and \overline{CLR} Inputs for Slow Input Transition Rates
- Edge Triggered From Active-High or Active-Low Gated Logic Inputs
- Retriggerable for Very Long Output Pulses
- Overriding Clear Terminates Output Pulse
- Glitch-Free Power-Up Reset On Outputs
- Latch-Up Performance Exceeds 100 mA Per JESD 78, Class II
- ESD Protection Exceeds JESD 22
 - 2000-V Human-Body Model (A114-A)
 - 200-V Machine Model (A115-A)
 - 1000-V Charged-Device Model (C101)

SN54AHC123A . . . J OR W PACKAGE
SN74AHC123A . . . D, DB, DGV, N, OR PW PACKAGE
(TOP VIEW)



SN54AHC123A . . . FK PACKAGE
(TOP VIEW)

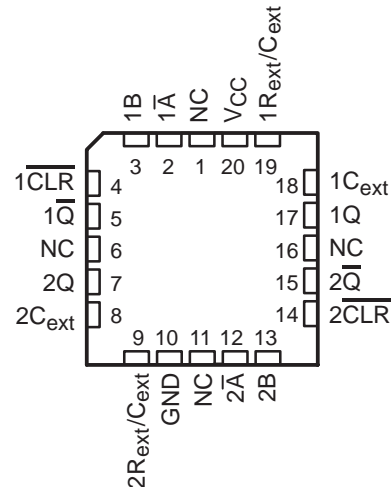

NC – No internal connection

description/ordering information

The 'AHC123A devices are dual retriggerable monostable multivibrators designed for 2-V to 5.5-V V_{CC} operation.

These edge-triggered multivibrators feature output pulse-duration control by three methods. In the first method, the \overline{A} input is low, and the B input goes high. In the second method, the B input is high, and the \overline{A} input goes low. In the third method, the \overline{A} input is low, the B input is high, and the clear (\overline{CLR}) input goes high.

ORDERING INFORMATION

| TA | PACKAGE† | | ORDERABLE PART NUMBER | TOP-SIDE MARKING |
|----------------|---------------|-----------------|-----------------------|------------------|
| –40°C to 85°C | PDIP – N | Tube | SN74AHC123AN | SN74AHC123AN |
| | SOIC – D | Tube | SN74AHC123AD | AHC123A |
| | | Tape and reel | SN74AHC123ADR | |
| | SSOP – DB | Tape and reel | SN74AHC123ADBR | HA123A |
| | TSSOP – PW | Tape and reel | SN74AHC123APWR | HA123A |
| TVSOP – DGV | Tape and reel | SN74AHC123ADGVR | HA123A | |
| –55°C to 125°C | CDIP – J | Tube | SNJ54AHC123AJ | SNJ54AHC123AJ |
| | CFP – W | Tube | SNJ54AHC123AW | SNJ54AHC123AW |
| | LCCC – FK | Tube | SNJ54AHC123AFK | SNJ54AHC123AFK |

† Package drawings, standard packing quantities, thermal data, symbolization, and PCB design guidelines are available at www.ti.com/sc/package.



Please be aware that an important notice concerning availability, standard warranty, and use in critical applications of Texas Instruments semiconductor products and disclaimers thereto appears at the end of this data sheet.

PRODUCTION DATA information is current as of publication date. Products conform to specifications per the terms of Texas Instruments standard warranty. Production processing does not necessarily include testing of all parameters.

 **TEXAS
INSTRUMENTS**

POST OFFICE BOX 655303 • DALLAS, TEXAS 75265

Copyright © 2005, Texas Instruments Incorporated
On products compliant to MIL-PRF-38535, all parameters are tested unless otherwise noted. On all other products, production processing does not necessarily include testing of all parameters.

SN54AHC123A, SN74AHC123A DUAL RETRIGGERABLE MONOSTABLE MULTIVIBRATORS

SCLS352H – JULY 1997 – REVISED OCTOBER 2005

description/ordering information (continued)

The output pulse duration is programmed by selecting external resistance and capacitance values. The external timing capacitor must be connected between C_{ext} and R_{ext}/C_{ext} (positive) and an external resistor connected between R_{ext}/C_{ext} and V_{CC} . To obtain variable pulse durations, connect an external variable resistance between R_{ext}/C_{ext} and V_{CC} . The output pulse duration also can be reduced by taking \overline{CLR} low.

Pulse triggering occurs at a particular voltage level and is not directly related to the transition time of the input pulse. The \overline{A} , B, and \overline{CLR} inputs have Schmitt triggers with sufficient hysteresis to handle slow input transition rates with jitter-free triggering at the outputs.







Once triggered, the basic pulse duration can be extended by retriggering the gated low-level-active (\overline{A}) or high-level-active (B) input. Pulse duration can be reduced by taking \overline{CLR} low. CLR input can be used to override \overline{A} or B inputs. The input/output timing diagram illustrates pulse control by retriggering the inputs and early clearing.

The variance in output pulse duration from device to device typically is less than $\pm 0.5\%$ for given external timing components. An example of this distribution for the 'AHC123A is shown in Figure 10. Variations in output pulse duration versus supply voltage and temperature are shown in Figure 6.

During power up, Q outputs are in the low state, and \overline{Q} outputs are in the high state. The outputs are glitch free, without applying a reset pulse.

For additional application information on multivibrators, see the application report *Designing With the SN74AHC123A and SN74AHCT123A*, literature number SCLA014.

FUNCTION TABLE
(each multivibrator)

| INPUTS | | | OUTPUTS | |
|--------|----------------|---|---|---|
| CLR | \overline{A} | B | Q | \overline{Q} |
| L | X | X | L | H |
| X | H | X | L [†] | H [†] |
| X | X | L | L [†] | H [†] |
| H | L | ↑ |  |  |
| H | ↓ | H |  |  |
| ↑ | L | H |  |  |

† These outputs are based on the assumption that the indicated steady-state conditions at the \overline{A} and B inputs have been set up long enough to complete any pulse started before the setup.

SN54AHC123A, SN74AHC123A DUAL RETRIGGERABLE MONOSTABLE MULTIVIBRATORS

SCLS352H – JULY 1997 – REVISED OCTOBER 2005

logic diagram, each multivibrator (positive logic)

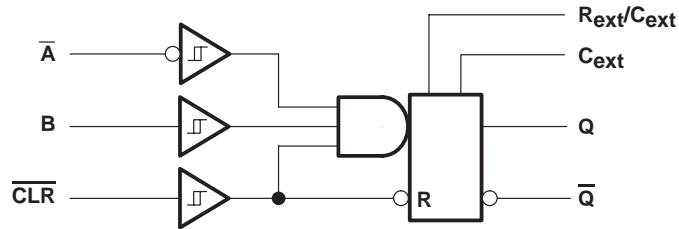

input/output timing diagram



SN54AHC123A, SN74AHC123A DUAL RETRIGGERABLE MONOSTABLE MULTIVIBRATORS

SCLS352H – JULY 1997 – REVISED OCTOBER 2005

absolute maximum ratings over operating free-air temperature (unless otherwise noted)†

| | |
|--|----------------------------|
| Supply voltage range, V_{CC} (see Note 1) | –0.5 V to 7 V |
| Input voltage range, V_I (see Note 2) | –0.5 V to 7 V |
| Output voltage range in high or low state, V_O (see Note 1) | –0.5 V to $V_{CC} + 0.5$ V |
| Output voltage range in power-off state, V_O (see Note 1) | –0.5 V to 7 V |
| Input clamp current, I_{IK} ($V_I < 0$) | –20 mA |
| Output clamp current, I_{OK} ($V_O < 0$ or $V_O > V_{CC}$) | ±20 mA |
| Continuous output current, I_O ($V_O = 0$ to V_{CC}) | ±25 mA |
| Continuous current through V_{CC} or GND | ±50 mA |
| Package thermal impedance, θ_{JA} (see Note 3): D package | 73°C/W |
| DB package | 82°C/W |
| DGV package | 120°C/W |
| N package | 67°C/W |
| PW package | 108°C/W |
| Storage temperature range, T_{stg} | –65°C to 150°C |

† Stresses beyond those listed under “absolute maximum ratings” may cause permanent damage to the device. These are stress ratings only, and functional operation of the device at these or any other conditions beyond those indicated under “recommended operating conditions” is not implied. Exposure to absolute-maximum-rated conditions for extended periods may affect device reliability.

- NOTES: 1. Voltage values are with respect to the network ground terminal.
 2. The input and output voltage ratings may be exceeded if the input and output current ratings are observed.
 3. The package thermal impedance is calculated in accordance with JESD 51-7.

recommended operating conditions (see Note 4)

| | | SN54AHC123A | | SN74AHC123A | | UNIT |
|--------------------------|--------------------------------|------------------------------|----------|-------------|----------|----------|
| | | MIN | MAX | MIN | MAX | |
| V_{CC} | Supply voltage | 2 | 5.5 | 2 | 5.5 | V |
| V_{IH} | High-level input voltage | $V_{CC} = 2$ V | | 1.5 | | V |
| | | $V_{CC} = 3$ V | | 2.1 | | |
| | | $V_{CC} = 5.5$ V | | 3.85 | | |
| V_{IL} | Low-level input voltage | $V_{CC} = 2$ V | | 0.5 | | V |
| | | $V_{CC} = 3$ V | | 0.9 | | |
| | | $V_{CC} = 5.5$ V | | 1.65 | | |
| V_I | Input voltage | 0 | 5.5 | 0 | 5.5 | V |
| V_O | Output voltage | 0 | V_{CC} | 0 | V_{CC} | V |
| I_{OH} | High-level output current | $V_{CC} = 2$ V | | –50 | | μ A |
| | | $V_{CC} = 3.3$ V \pm 0.3 V | | –4 | | |
| | | $V_{CC} = 5$ V \pm 0.5 V | | –8 | | |
| I_{OL} | Low-level output current | $V_{CC} = 2$ V | | 50 | | μ A |
| | | $V_{CC} = 3.3$ V \pm 0.3 V | | 4 | | |
| | | $V_{CC} = 5$ V \pm 0.5 V | | 8 | | |
| R_{ext} | External timing resistance | $V_{CC} = 2$ V | | 5k | | Ω |
| | | $V_{CC} > 3$ V | | 1k | | |
| $\Delta t/\Delta V_{CC}$ | Power-up ramp rate | 1 | | 1 | | ms/V |
| T_A | Operating free-air temperature | –55 | 125 | –40 | 85 | °C |

NOTE 4: Unused R_{ext}/C_{ext} terminals should be left unconnected. All remaining unused inputs of the device must be held at V_{CC} or GND to ensure proper device operation. Refer to the TI application report, *Implications of Slow or Floating CMOS Inputs*, literature number SCBA004.



SN54AHC123A, SN74AHC123A DUAL RETRIGGERABLE MONOSTABLE MULTIVIBRATORS

SCLS352H – JULY 1997 – REVISED OCTOBER 2005

electrical characteristics over recommended operating free-air temperature range (unless otherwise noted)

| PARAMETER | TEST CONDITIONS | V _{CC} | T _A = 25°C | | | SN54AHC123A | | SN74AHC123A | | UNIT | |
|-----------------|---|---|-----------------------|-----|------|-------------|-----|-------------|------|------|----|
| | | | MIN | TYP | MAX | MIN | MAX | MIN | MAX | | |
| V _{OH} | I _{OH} = -50 μA | 2 V | 1.9 | 2 | | 1.9 | | 1.9 | V | | |
| | | 3 V | 2.9 | 3 | | 2.9 | | 2.9 | | | |
| | | 4.5 V | 4.4 | 4.5 | | 4.4 | | 4.4 | | | |
| | I _{OH} = -4 mA | 3 V | 2.58 | | | 2.48 | | 2.48 | | | |
| | I _{OH} = -8 mA | 4.5 V | 3.94 | | | 3.8 | | 3.8 | | | |
| V _{OL} | I _{OL} = 50 μA | 2 V | | | 0.1 | | 0.1 | | 0.1 | V | |
| | | 3 V | | | 0.1 | | 0.1 | | 0.1 | | |
| | | 4.5 V | | | 0.1 | | 0.1 | | 0.1 | | |
| | I _{OL} = 4 mA | 3 V | | | 0.36 | | 0.5 | | 0.44 | | |
| | I _{OL} = 8 mA | 4.5 V | | | 0.36 | | 0.5 | | 0.44 | | |
| I _I | R _{ext} /C _{ext} [†] | V _I = V _{CC} or GND | 5.5 V | | | ±0.25 | | ±2.5 | | ±2.5 | μA |
| | \overline{A} , B, and \overline{CLR} | V _I = V _{CC} or GND | 0 V to 5.5 V | | | ±0.1 | | ±1* | | ±1 | |
| I _{CC} | Quiescent | V _I = V _{CC} or GND, I _O = 0 | 5.5 V | | | 4 | | 40 | | 40 | μA |
| I _{CC} | Active state (per circuit) | V _I = V _{CC} or GND, R _{ext} /C _{ext} = 0.5 V _{CC} | 3 V | | 160 | 250 | | 280 | | 280 | μA |
| | | | 4.5 V | | 280 | 500 | | 650 | | 650 | |
| | | | 5.5 V | | 360 | 750 | | 975 | | 975 | |
| C _i | | V _I = V _{CC} or GND | 5 V | | 1.9 | 10 | | | | 10 | pF |

* On products compliant to MIL-PRF-38535, this parameter is not production tested at V_{CC} = 0 V.

† This test is performed with the terminal in the off-state condition.

timing requirements over recommended operating free-air temperature range, V_{CC} = 3.3 V ± 0.3 V (unless otherwise noted) (see Figure 1)

| | TEST CONDITIONS | T _A = 25°C | | | SN54AHC123A | | SN74AHC123A | | UNIT |
|--------------------------------------|---|-----------------------|-----|-----|-------------|-----|-------------|-----|------|
| | | MIN | TYP | MAX | MIN | MAX | MIN | MAX | |
| t _w Pulse duration | \overline{CLR} | | 5 | | | 5 | | 5 | ns |
| | \overline{A} or B trigger | | 5 | | | 5 | | 5 | |
| t _{rr} Pulse retrigger time | R _{ext} = 1 kΩ, C _{ext} = 100 pF | | ‡ | 76 | | ‡ | | ‡ | ns |
| | R _{ext} = 1 kΩ, C _{ext} = 0.01 μF | | ‡ | 1.8 | | ‡ | | ‡ | μs |

‡ See retriggering data in the *application information* section.

timing requirements over recommended operating free-air temperature range, V_{CC} = 5 V ± 0.5 V (unless otherwise noted) (see Figure 1)

| | TEST CONDITIONS | T _A = 25°C | | | SN54AHC123A | | SN74AHC123A | | UNIT |
|--------------------------------------|---|-----------------------|-----|-----|-------------|-----|-------------|-----|------|
| | | MIN | TYP | MAX | MIN | MAX | MIN | MAX | |
| t _w Pulse duration | \overline{CLR} | | 5 | | | 5 | | 5 | ns |
| | \overline{A} or B trigger | | 5 | | | 5 | | 5 | |
| t _{rr} Pulse retrigger time | R _{ext} = 1 kΩ, C _{ext} = 100 pF | | ‡ | 59 | | ‡ | | ‡ | ns |
| | R _{ext} = 1 kΩ, C _{ext} = 0.01 μF | | ‡ | 1.5 | | ‡ | | ‡ | μs |

‡ See retriggering data in the *application information* section.



SN54AHC123A, SN74AHC123A DUAL RETRIGGERABLE MONOSTABLE MULTIVIBRATORS

SCLS352H – JULY 1997 – REVISED OCTOBER 2005

switching characteristics over recommended operating free-air temperature range,
 $V_{CC} = 3.3\text{ V} \pm 0.3\text{ V}$ (unless otherwise noted) (see Figure 1)

| PARAMETER | FROM (INPUT) | TO (OUTPUT) | TEST CONDITIONS | $T_A = 25^\circ\text{C}$ | | | SN54AHC123A | | SN74AHC123A | | UNIT |
|-----------------------|---------------------------------|----------------|--|--------------------------|-------|-----|-------------|-------|-------------|------|---------------|
| | | | | MIN | TYP | MAX | MIN | MAX | MIN | MAX | |
| t_{PLH} | \bar{A} or B | Q or \bar{Q} | $C_L = 15\text{ pF}$ | 9.5* | 20.6* | | 1* | 24* | 1 | 24 | ns |
| t_{PHL} | | | | 10.2* | 20.6* | 1* | 24* | 1 | 24 | | |
| t_{PLH} | $\overline{\text{CLR}}$ | Q or \bar{Q} | $C_L = 15\text{ pF}$ | 7.5* | 15.8* | | 1* | 18.5* | 1 | 18.5 | ns |
| t_{PHL} | | | | 9.3* | 15.8* | 1* | 18.5* | 1 | 18.5 | | |
| t_{PLH} | $\overline{\text{CLR}}$ trigger | Q or \bar{Q} | $C_L = 15\text{ pF}$ | 10* | 22.4* | | 1* | 26* | 1 | 26 | ns |
| t_{PHL} | | | | 10.6* | 22.4* | 1* | 26* | 1 | 26 | | |
| t_{PLH} | \bar{A} or B | Q or \bar{Q} | $C_L = 50\text{ pF}$ | 10.5 | 24.1 | | 1 | 27.5 | 1 | 27.5 | ns |
| t_{PHL} | | | | 11.8 | 24.1 | 1 | 27.5 | 1 | 27.5 | | |
| t_{PLH} | $\overline{\text{CLR}}$ | Q or \bar{Q} | $C_L = 50\text{ pF}$ | 8.9 | 19.3 | | 1 | 22 | 1 | 22 | ns |
| t_{PHL} | | | | 10.5 | 19.3 | 1 | 22 | 1 | 22 | | |
| t_{PLH} | $\overline{\text{CLR}}$ trigger | Q or \bar{Q} | $C_L = 50\text{ pF}$ | 11 | 25.9 | | 1 | 29.5 | 1 | 29.5 | ns |
| t_{PHL} | | | | 12.3 | 25.9 | 1 | 29.5 | 1 | 29.5 | | |
| t_w^\dagger | | Q or \bar{Q} | $C_L = 50\text{ pF}$, $C_{ext} = 28\text{ pF}$, $R_{ext} = 2\text{ k}\Omega$ | 182 | 240 | | 300 | | 300 | ns | |
| | | | $C_L = 50\text{ pF}$, $C_{ext} = 0.01\text{ }\mu\text{F}$, $R_{ext} = 10\text{ k}\Omega$ | 90 | 100 | 110 | 90 | 110 | 90 | 110 | μs |
| | | | $C_L = 50\text{ pF}$, $C_{ext} = 0.1\text{ }\mu\text{F}$, $R_{ext} = 10\text{ k}\Omega$ | 0.9 | 1 | 1.1 | 0.9 | 1.1 | 0.9 | 1.1 | ms |
| Δt_w^\ddagger | | | | ± 1 | | | | | | % | |

* On products compliant to MIL-PRF-38535, this parameter is not production tested.

$^\dagger t_w$ = Pulse duration at Q and \bar{Q} outputs

$^\ddagger \Delta t_w$ = Output pulse-duration variation (Q and \bar{Q}) between circuits in same package

SN54AHC123A, SN74AHC123A DUAL RETRIGGERABLE MONOSTABLE MULTIVIBRATORS

SCLS352H – JULY 1997 – REVISED OCTOBER 2005

switching characteristics over recommended operating free-air temperature range,
 $V_{CC} = 5\text{ V} \pm 0.5\text{ V}$ (unless otherwise noted) (see Figure 1)

| PARAMETER | FROM (INPUT) | TO (OUTPUT) | TEST CONDITIONS | $T_A = 25^\circ\text{C}$ | | | SN54AHC123A | | SN74AHC123A | | UNIT |
|-----------------------|---------------------------------|----------------|--|--------------------------|-------|-----|-------------|-----|-------------|-----|---------------|
| | | | | MIN | TYP | MAX | MIN | MAX | MIN | MAX | |
| t_{PLH} | \bar{A} or B | Q or \bar{Q} | $C_L = 15\text{ pF}$ | 6.5* | 12* | | 1* | 14* | 1 | 14 | ns |
| t_{PHL} | | | | 7.1* | 12* | | 1* | 14* | 1 | 14 | |
| t_{PLH} | $\overline{\text{CLR}}$ | Q or \bar{Q} | $C_L = 15\text{ pF}$ | 5.3* | 9.4* | | 1* | 11* | 1 | 11 | ns |
| t_{PHL} | | | | 6.5* | 9.4* | | 1* | 11* | 1 | 11 | |
| t_{PLH} | $\overline{\text{CLR}}$ trigger | Q or \bar{Q} | $C_L = 15\text{ pF}$ | 6.9* | 12.9* | | 1* | 15* | 1 | 15 | ns |
| t_{PHL} | | | | 7.4* | 12.9* | | 1* | 15* | 1 | 15 | |
| t_{PLH} | \bar{A} or B | Q or \bar{Q} | $C_L = 50\text{ pF}$ | 7.3 | 14 | | 1 | 16 | 1 | 16 | ns |
| t_{PHL} | | | | 8.3 | 14 | | 1 | 16 | 1 | 16 | |
| t_{PLH} | $\overline{\text{CLR}}$ | Q or \bar{Q} | $C_L = 50\text{ pF}$ | 6.3 | 11.4 | | 1 | 13 | 1 | 13 | ns |
| t_{PHL} | | | | 7.4 | 11.4 | | 1 | 13 | 1 | 13 | |
| t_{PLH} | $\overline{\text{CLR}}$ trigger | Q or \bar{Q} | $C_L = 50\text{ pF}$ | 7.6 | 14.9 | | 1 | 17 | 1 | 17 | ns |
| t_{PHL} | | | | 8.7 | 14.9 | | 1 | 17 | 1 | 17 | |
| t_w^\dagger | | Q or \bar{Q} | $C_L = 50\text{ pF}$, $C_{ext} = 28\text{ pF}$, $R_{ext} = 2\text{ k}\Omega$ | 167 | 200 | | | 240 | | 240 | ns |
| | | | $C_L = 50\text{ pF}$, $C_{ext} = 0.01\text{ }\mu\text{F}$, $R_{ext} = 10\text{ k}\Omega$ | 90 | 100 | 110 | 90 | 110 | 90 | 110 | μs |
| | | | $C_L = 50\text{ pF}$, $C_{ext} = 0.1\text{ }\mu\text{F}$, $R_{ext} = 10\text{ k}\Omega$ | 0.9 | 1 | 1.1 | 0.9 | 1.1 | 0.9 | 1.1 | ms |
| Δt_w^\ddagger | | | | ± 1 | | | | | | % | |

* On products compliant to MIL-PRF-38535, this parameter is not production tested.

$^\dagger t_w$ = Pulse duration at Q and \bar{Q} outputs

$^\ddagger \Delta t_w$ = Output pulse-duration variation (Q and \bar{Q}) between circuits in same package

operating characteristics, $V_{CC} = 5\text{ V}$, $T_A = 25^\circ\text{C}$

| PARAMETER | TEST CONDITIONS | TYP | UNIT |
|--|-----------------|-----|------|
| C_{pd} Power dissipation capacitance | No load | 29 | pF |



SN54AHC123A, SN74AHC123A DUAL RETRIGGERABLE MONOSTABLE MULTIVIBRATORS

SCLS352H – JULY 1997 – REVISED OCTOBER 2005

PARAMETER MEASUREMENT INFORMATION

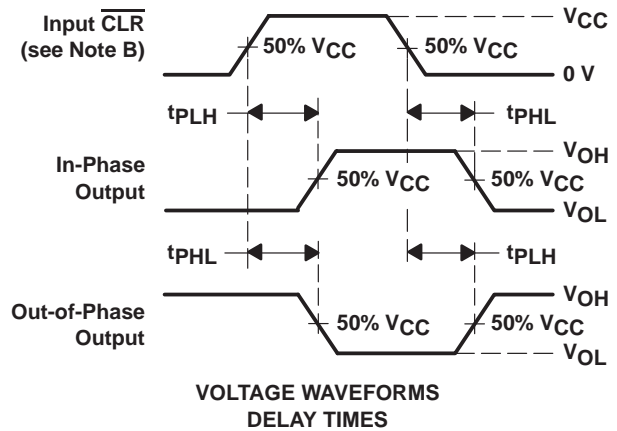
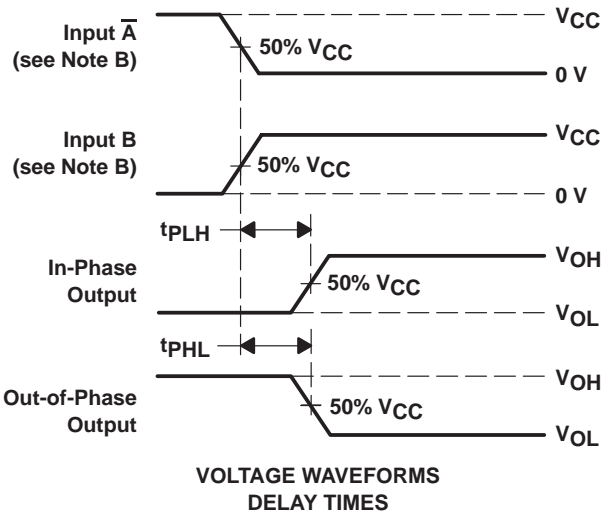
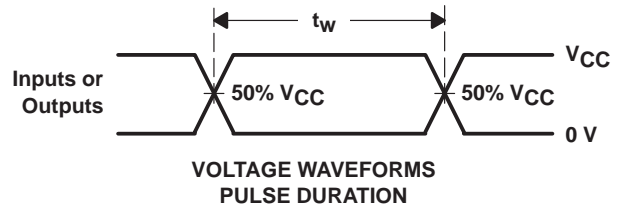
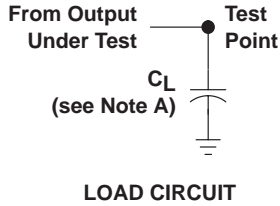

- NOTES: A. C_L includes probe and jig capacitance.
 B. All input pulses are supplied by generators having the following characteristics: $Z_O = 50\ \Omega$, $t_r = 3\text{ ns}$, $t_f = 3\text{ ns}$.
 C. The outputs are measured one at a time, with one input transition per measurement.

Figure 1. Load Circuit and Voltage Waveforms

APPLICATION INFORMATION

caution in use

To prevent malfunctions due to noise, connect a high-frequency capacitor between V_{CC} and GND, and keep the wiring between the external components and C_{ext} and R_{ext}/C_{ext} terminals as short as possible.

power-down considerations

Large values of C_{ext} can cause problems when powering down the 'AHC123A devices because of the amount of energy stored in the capacitor. When a system containing this device is powered down, the capacitor can discharge from V_{CC} through the protection diodes at pin 2 or pin 14. Current through the input protection diodes must be limited to 30 mA; therefore, the turn-off time of the V_{CC} power supply must not be faster than $t = V_{CC} \times C_{ext}/30 \text{ mA}$. For example, if $V_{CC} = 5 \text{ V}$ and $C_{ext} = 15 \text{ pF}$, the V_{CC} supply must turn off no faster than $t = (5 \text{ V}) \times (15 \text{ pF})/30 \text{ mA} = 2.5 \text{ ns}$. Usually, this is not a problem because power supplies are heavily filtered and cannot discharge at this rate. When a more rapid decrease of V_{CC} to zero occurs, the 'AHC123A devices can sustain damage. To avoid this possibility, use external clamping diodes.

output pulse duration

The output pulse duration, t_w , is determined primarily by the values of the external capacitance (C_T) and timing resistance (R_T). The timing components are connected as shown in Figure 2.



Figure 2. Timing-Component Connections

The pulse duration is given by:

$$t_w = K \times R_T \times C_T \tag{1}$$

if C_T is $\geq 1000 \text{ pF}$, $K = 1.0$ or
 if C_T is $< 1000 \text{ pF}$, K can be determined from Figure 9

where:

- t_w = pulse duration in ns
- R_T = external timing resistance in $k\Omega$
- C_T = external capacitance in pF
- K = multiplier factor

Equation 1 and Figure 3 can be used to determine values for pulse duration, external resistance, and external capacitance.

SN54AHC123A, SN74AHC123A DUAL RETRIGGERABLE MONOSTABLE MULTIVIBRATORS

SCLS352H – JULY 1997 – REVISED OCTOBER 2005

APPLICATION INFORMATION

retriggering data

The minimum input retriggering time (t_{MIR}) is the minimum time required after the initial signal before retriggering the input. After t_{MIR} , the device retriggers the output. Experimentally, it also can be shown that to retrigger the output pulse, the two adjacent input signals should be t_{MIR} apart, where $t_{MIR} = 0.30 \times t_w$. The retrigger pulse duration is calculated as shown in Figure 3.

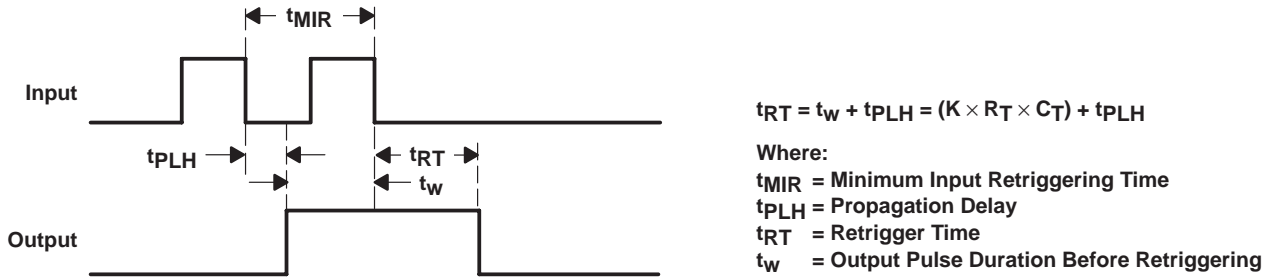
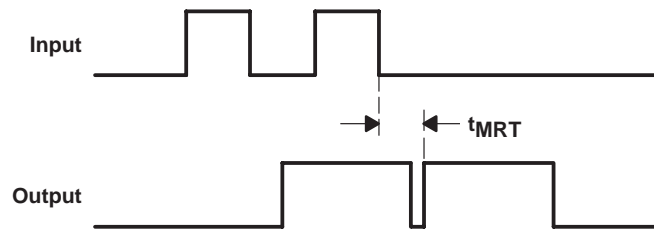

Figure 3. Retrigger Pulse Duration

The minimum value from the end of the input pulse to the beginning of the retriggered output should be approximately 15 ns to ensure a retriggered output (see Figure 4).



t_{MRT} = Minimum Time Between the End of the Second Input Pulse and the Beginning of the Retriggered Output
 $t_{MRT} = 15 \text{ ns}$

Figure 4. Input/Output Requirements

APPLICATION INFORMATION†

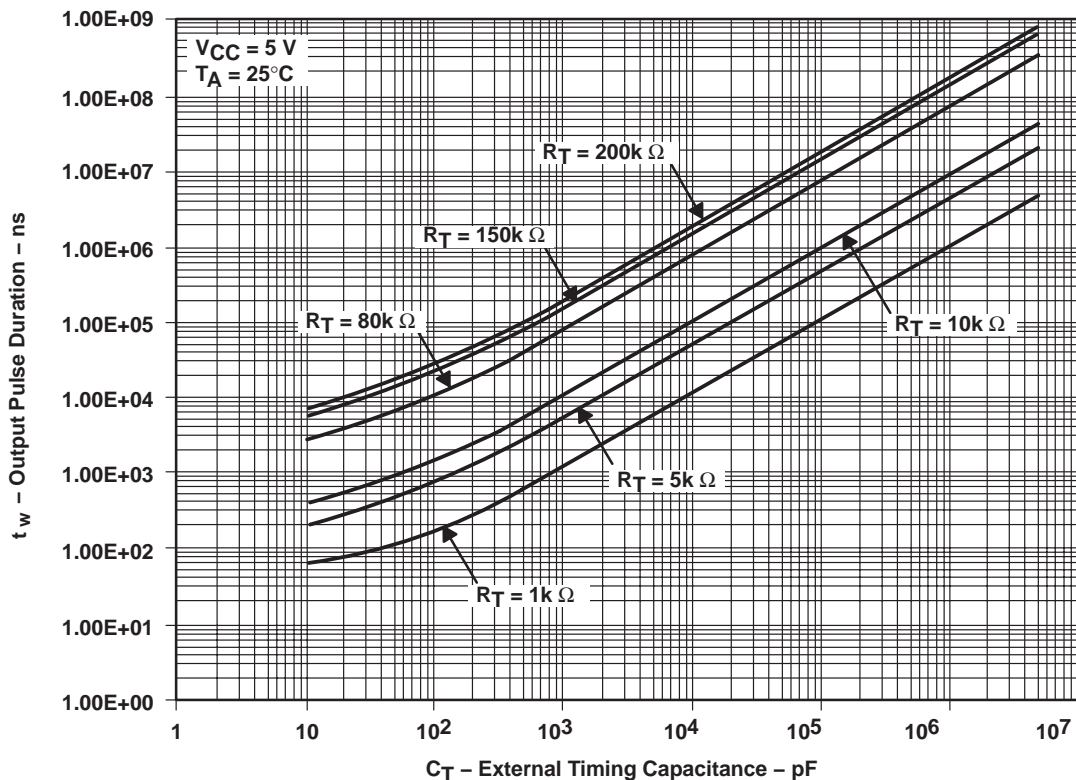

Figure 5. Output Pulse Duration vs External Timing Capacitance

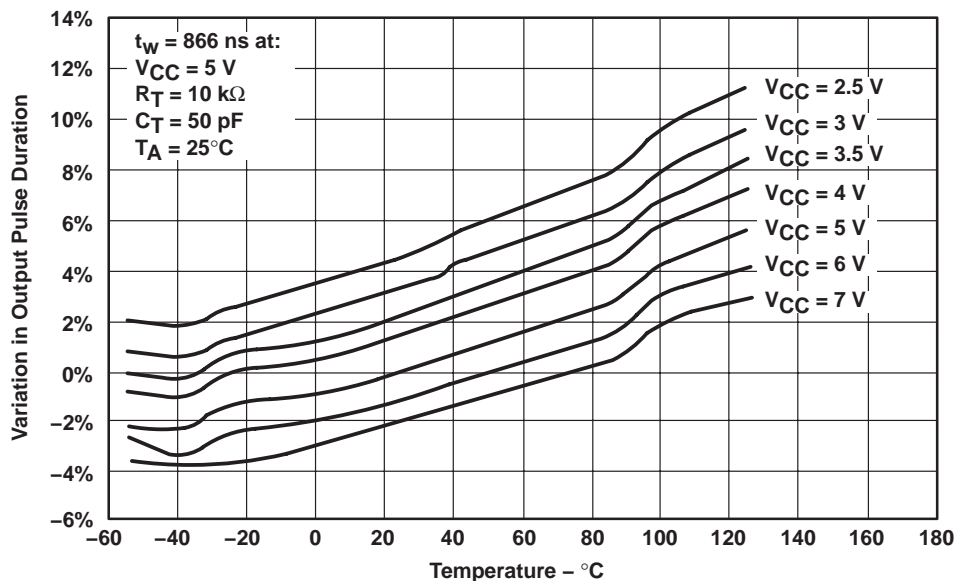

Figure 6. Variations in Output Pulse Duration vs Temperature

† Operation of the device at these or any other conditions beyond those indicated under "recommended operating conditions" is not implied.

SN54AHC123A, SN74AHC123A DUAL RETRIGGERABLE MONOSTABLE MULTIVIBRATORS

SCLS352H – JULY 1997 – REVISED OCTOBER 2005

APPLICATION INFORMATION†



Figure 7



Figure 8



Figure 9

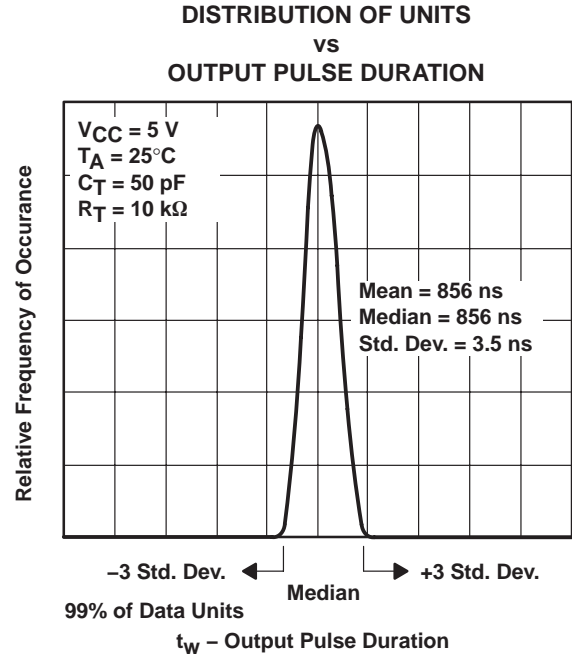





Figure 10

† Operation of the device at these or any other conditions beyond those indicated under "recommended operating conditions" is not implied.

PACKAGING INFORMATION

| Orderable Device | Status (1) | Package Type | Package Drawing | Pins | Package Qty | Eco Plan (2) | Lead/Ball Finish (6) | MSL Peak Temp (3) | Op Temp (°C) | Device Marking (4/5) | Samples |
|-------------------|---------------|--------------|-----------------|------|-------------|-------------------------|-------------------------|----------------------|--------------|---------------------------------------|-------------------------|
| 5962-9860801Q2A | ACTIVE | LCCC | FK | 20 | 1 | TBD | POST-PLATE | N / A for Pkg Type | -55 to 125 | 5962-9860801Q2A SNJ54AHC 123AFK | Samples |
| 5962-9860801QEA | ACTIVE | CDIP | J | 16 | 1 | TBD | A42 | N / A for Pkg Type | -55 to 125 | 5962-9860801QE A SNJ54AHC123AJ | Samples |
| 5962-9860801QFA | ACTIVE | CFP | W | 16 | 1 | TBD | A42 | N / A for Pkg Type | -55 to 125 | 5962-9860801QF A SNJ54AHC123AW | Samples |
| SN74AHC123AD | ACTIVE | SOIC | D | 16 | 40 | Green (RoHS & no Sb/Br) | CU NIPDAU | Level-1-260C-UNLIM | -40 to 85 | AHC123A | Samples |
| SN74AHC123ADBR | ACTIVE | SSOP | DB | 16 | 2000 | Green (RoHS & no Sb/Br) | CU NIPDAU | Level-1-260C-UNLIM | -40 to 85 | HA123A | Samples |
| SN74AHC123ADG4 | ACTIVE | SOIC | D | 16 | 40 | Green (RoHS & no Sb/Br) | CU NIPDAU | Level-1-260C-UNLIM | -40 to 85 | AHC123A | Samples |
| SN74AHC123ADGV | ACTIVE | TVSOP | DGV | 16 | 2000 | Green (RoHS & no Sb/Br) | CU NIPDAU | Level-1-260C-UNLIM | -40 to 85 | HA123A | Samples |
| SN74AHC123ADGVRE4 | ACTIVE | TVSOP | DGV | 16 | 2000 | Green (RoHS & no Sb/Br) | CU NIPDAU | Level-1-260C-UNLIM | -40 to 85 | HA123A | Samples |
| SN74AHC123ADR | ACTIVE | SOIC | D | 16 | 2500 | Green (RoHS & no Sb/Br) | CU NIPDAU | Level-1-260C-UNLIM | -40 to 85 | AHC123A | Samples |
| SN74AHC123ADRE4 | ACTIVE | SOIC | D | 16 | 2500 | Green (RoHS & no Sb/Br) | CU NIPDAU | Level-1-260C-UNLIM | -40 to 85 | AHC123A | Samples |
| SN74AHC123ADRG4 | ACTIVE | SOIC | D | 16 | 2500 | Green (RoHS & no Sb/Br) | CU NIPDAU | Level-1-260C-UNLIM | -40 to 85 | AHC123A | Samples |
| SN74AHC123AN | ACTIVE | PDIP | N | 16 | 25 | Pb-Free (RoHS) | CU NIPDAU | N / A for Pkg Type | -40 to 85 | SN74AHC123AN | Samples |
| SN74AHC123APWR | ACTIVE | TSSOP | PW | 16 | 2000 | Green (RoHS & no Sb/Br) | CU NIPDAU CU SN | Level-1-260C-UNLIM | -40 to 85 | HA123A | Samples |
| SN74AHC123APWRE4 | ACTIVE | TSSOP | PW | 16 | 2000 | Green (RoHS & no Sb/Br) | CU NIPDAU | Level-1-260C-UNLIM | -40 to 85 | HA123A | Samples |
| SN74AHC123APWRG4 | ACTIVE | TSSOP | PW | 16 | 2000 | Green (RoHS & no Sb/Br) | CU NIPDAU | Level-1-260C-UNLIM | -40 to 85 | HA123A | Samples |

| Orderable Device | Status (1) | Package Type | Package Drawing | Pins | Package Qty | Eco Plan (2) | Lead/Ball Finish (6) | MSL Peak Temp (3) | Op Temp (°C) | Device Marking (4/5) | Samples |
|------------------|---------------|--------------|--------------------|------|----------------|-----------------|-------------------------|----------------------|--------------|---|---|
| SNJ54AHC123AFK | ACTIVE | LCCC | FK | 20 | 1 | TBD | POST-PLATE | N / A for Pkg Type | -55 to 125 | 5962- 9860801Q2A SNJ54AHC 123AFK |  |
| SNJ54AHC123AJ | ACTIVE | CDIP | J | 16 | 1 | TBD | A42 | N / A for Pkg Type | -55 to 125 | 5962-9860801QE A SNJ54AHC123AJ |  |
| SNJ54AHC123AW | ACTIVE | CFP | W | 16 | 1 | TBD | A42 | N / A for Pkg Type | -55 to 125 | 5962-9860801QF A SNJ54AHC123AW |  |

(1) The marketing status values are defined as follows:

ACTIVE: Product device recommended for new designs.

LIFEBUY: TI has announced that the device will be discontinued, and a lifetime-buy period is in effect.

NRND: Not recommended for new designs. Device is in production to support existing customers, but TI does not recommend using this part in a new design.

PREVIEW: Device has been announced but is not in production. Samples may or may not be available.

OBSELETE: TI has discontinued the production of the device.

(2) Eco Plan - The planned eco-friendly classification: Pb-Free (RoHS), Pb-Free (RoHS Exempt), or Green (RoHS & no Sb/Br) - please check <http://www.ti.com/productcontent> for the latest availability information and additional product content details.

TBD: The Pb-Free/Green conversion plan has not been defined.

Pb-Free (RoHS): TI's terms "Lead-Free" or "Pb-Free" mean semiconductor products that are compatible with the current RoHS requirements for all 6 substances, including the requirement that lead not exceed 0.1% by weight in homogeneous materials. Where designed to be soldered at high temperatures, TI Pb-Free products are suitable for use in specified lead-free processes.

Pb-Free (RoHS Exempt): This component has a RoHS exemption for either 1) lead-based flip-chip solder bumps used between the die and package, or 2) lead-based die adhesive used between the die and leadframe. The component is otherwise considered Pb-Free (RoHS compatible) as defined above.

Green (RoHS & no Sb/Br): TI defines "Green" to mean Pb-Free (RoHS compatible), and free of Bromine (Br) and Antimony (Sb) based flame retardants (Br or Sb do not exceed 0.1% by weight in homogeneous material)

(3) MSL, Peak Temp. - The Moisture Sensitivity Level rating according to the JEDEC industry standard classifications, and peak solder temperature.

(4) There may be additional marking, which relates to the logo, the lot trace code information, or the environmental category on the device.

(5) Multiple Device Markings will be inside parentheses. Only one Device Marking contained in parentheses and separated by a "-" will appear on a device. If a line is indented then it is a continuation of the previous line and the two combined represent the entire Device Marking for that device.

(6) Lead/Ball Finish - Orderable Devices may have multiple material finish options. Finish options are separated by a vertical ruled line. Lead/Ball Finish values may wrap to two lines if the finish value exceeds the maximum column width.

Important Information and Disclaimer: The information provided on this page represents TI's knowledge and belief as of the date that it is provided. TI bases its knowledge and belief on information provided by third parties, and makes no representation or warranty as to the accuracy of such information. Efforts are underway to better integrate information from third parties. TI has taken and continues to take reasonable steps to provide representative and accurate information but may not have conducted destructive testing or chemical analysis on incoming materials and chemicals. TI and TI suppliers consider certain information to be proprietary, and thus CAS numbers and other limited information may not be available for release.

In no event shall TI's liability arising out of such information exceed the total purchase price of the TI part(s) at issue in this document sold by TI to Customer on an annual basis.

OTHER QUALIFIED VERSIONS OF SN54AHC123A, SN74AHC123A :

- Catalog: [SN74AHC123A](#)
- Enhanced Product: [SN74AHC123A-EP](#)
- Military: [SN54AHC123A](#)

NOTE: Qualified Version Definitions:

- Catalog - TI's standard catalog product
- Enhanced Product - Supports Defense, Aerospace and Medical Applications
- Military - QML certified for Military and Defense Applications

TAPE AND REEL INFORMATION

QUADRANT ASSIGNMENTS FOR PIN 1 ORIENTATION IN TAPE

*All dimensions are nominal

| Device | Package Type | Package Drawing | Pins | SPQ | Reel Diameter (mm) | Reel Width W1 (mm) | A0 (mm) | B0 (mm) | K0 (mm) | P1 (mm) | W (mm) | Pin1 Quadrant |
|------------------|--------------|-----------------|------|------|--------------------|--------------------|---------|---------|---------|---------|--------|---------------|
| SN74AHC123ADBR | SSOP | DB | 16 | 2000 | 330.0 | 16.4 | 8.2 | 6.6 | 2.5 | 12.0 | 16.0 | Q1 |
| SN74AHC123ADGVR | TVSOP | DGV | 16 | 2000 | 330.0 | 12.4 | 6.8 | 4.0 | 1.6 | 8.0 | 12.0 | Q1 |
| SN74AHC123ADR | SOIC | D | 16 | 2500 | 330.0 | 16.4 | 6.5 | 10.3 | 2.1 | 8.0 | 16.0 | Q1 |
| SN74AHC123APWR | TSSOP | PW | 16 | 2000 | 330.0 | 12.4 | 6.9 | 5.6 | 1.6 | 8.0 | 12.0 | Q1 |
| SN74AHC123APWR | TSSOP | PW | 16 | 2000 | 330.0 | 12.4 | 6.9 | 5.6 | 1.6 | 8.0 | 12.0 | Q1 |
| SN74AHC123APWRG4 | TSSOP | PW | 16 | 2000 | 330.0 | 12.4 | 6.9 | 5.6 | 1.6 | 8.0 | 12.0 | Q1 |

TAPE AND REEL BOX DIMENSIONS

*All dimensions are nominal

| Device | Package Type | Package Drawing | Pins | SPQ | Length (mm) | Width (mm) | Height (mm) |
|------------------|--------------|-----------------|------|------|-------------|------------|-------------|
| SN74AHC123ADBR | SSOP | DB | 16 | 2000 | 367.0 | 367.0 | 38.0 |
| SN74AHC123ADGVR | TVSOP | DGV | 16 | 2000 | 367.0 | 367.0 | 35.0 |
| SN74AHC123ADR | SOIC | D | 16 | 2500 | 333.2 | 345.9 | 28.6 |
| SN74AHC123APWR | TSSOP | PW | 16 | 2000 | 364.0 | 364.0 | 27.0 |
| SN74AHC123APWR | TSSOP | PW | 16 | 2000 | 367.0 | 367.0 | 35.0 |
| SN74AHC123APWRG4 | TSSOP | PW | 16 | 2000 | 367.0 | 367.0 | 35.0 |

J (R-GDIP-T**)

14 LEADS SHOWN

CERAMIC DUAL IN-LINE PACKAGE



| DIM \ PINS ** | 14 | 16 | 18 | 20 |
|---------------|------------------------|------------------------|------------------------|------------------------|
| A | 0.300 (7,62) BSC | 0.300 (7,62) BSC | 0.300 (7,62) BSC | 0.300 (7,62) BSC |
| B MAX | 0.785 (19,94) | .840 (21,34) | 0.960 (24,38) | 1.060 (26,92) |
| B MIN | — | — | — | — |
| C MAX | 0.300 (7,62) | 0.300 (7,62) | 0.310 (7,87) | 0.300 (7,62) |
| C MIN | 0.245 (6,22) | 0.245 (6,22) | 0.220 (5,59) | 0.245 (6,22) |



4040083/F 03/03

- NOTES:
- All linear dimensions are in inches (millimeters).
 - This drawing is subject to change without notice.
 - This package is hermetically sealed with a ceramic lid using glass frit.
 - Index point is provided on cap for terminal identification only on press ceramic glass frit seal only.
 - Falls within MIL STD 1835 GDIP1-T14, GDIP1-T16, GDIP1-T18 and GDIP1-T20.

W (R-GDFP-F16)

CERAMIC DUAL FLATPACK

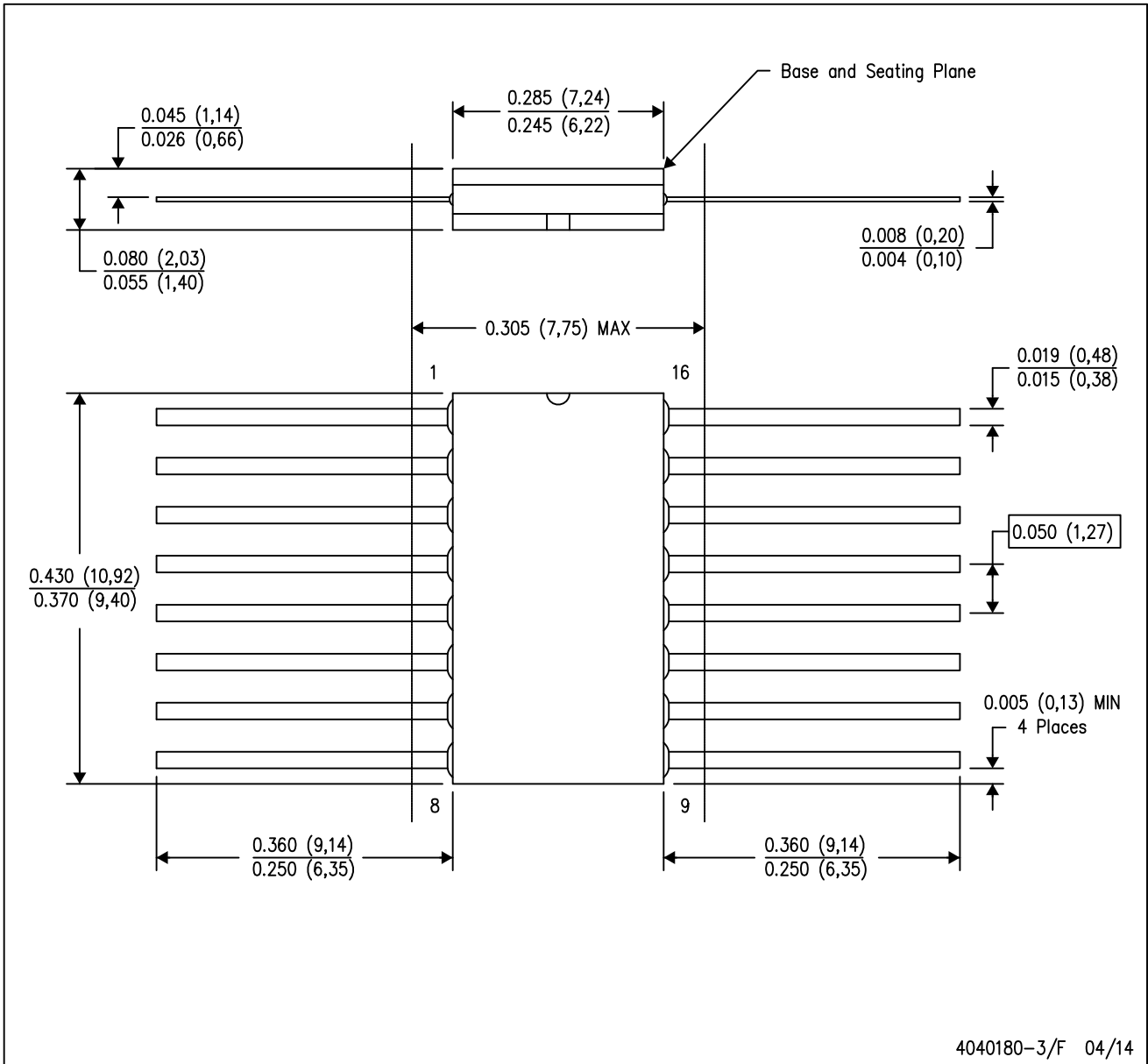

- NOTES:
- A. All linear dimensions are in inches (millimeters).
 - B. This drawing is subject to change without notice.
 - C. This package can be hermetically sealed with a ceramic lid using glass frit.
 - D. Index point is provided on cap for terminal identification only.
 - E. Falls within MIL STD 1835 GDFP2-F16

FK (S-CQCC-N**)

LEADLESS CERAMIC CHIP CARRIER

28 TERMINAL SHOWN



| NO. OF TERMINALS ** | A | | B | |
|---------------------|------------------|------------------|------------------|------------------|
| | MIN | MAX | MIN | MAX |
| 20 | 0.342 (8,69) | 0.358 (9,09) | 0.307 (7,80) | 0.358 (9,09) |
| 28 | 0.442 (11,23) | 0.458 (11,63) | 0.406 (10,31) | 0.458 (11,63) |
| 44 | 0.640 (16,26) | 0.660 (16,76) | 0.495 (12,58) | 0.560 (14,22) |
| 52 | 0.740 (18,78) | 0.761 (19,32) | 0.495 (12,58) | 0.560 (14,22) |
| 68 | 0.938 (23,83) | 0.962 (24,43) | 0.850 (21,6) | 0.858 (21,8) |
| 84 | 1.141 (28,99) | 1.165 (29,59) | 1.047 (26,6) | 1.063 (27,0) |



4040140/D 01/11

- NOTES:
- All linear dimensions are in inches (millimeters).
 - This drawing is subject to change without notice.
 - This package can be hermetically sealed with a metal lid.
 - Falls within JEDEC MS-004

N (R-PDIP-T**)

PLASTIC DUAL-IN-LINE PACKAGE

16 PINS SHOWN



- NOTES:
- A. All linear dimensions are in inches (millimeters).
 - B. This drawing is subject to change without notice.
 - Falls within JEDEC MS-001, except 18 and 20 pin minimum body length (Dim A).
 - The 20 pin end lead shoulder width is a vendor option, either half or full width.

DGV (R-PDSO-G**)

PLASTIC SMALL-OUTLINE

24 PINS SHOWN



4073251/E 08/00

- NOTES: A. All linear dimensions are in millimeters.
 B. This drawing is subject to change without notice.
 C. Body dimensions do not include mold flash or protrusion, not to exceed 0,15 per side.
 D. Falls within JEDEC: 24/48 Pins – MO-153
 14/16/20/56 Pins – MO-194

D (R-PDSO-G16)

PLASTIC SMALL OUTLINE



4040047-6/M 06/11

- NOTES:
- A. All linear dimensions are in inches (millimeters).
 - B. This drawing is subject to change without notice.
 - C. Body length does not include mold flash, protrusions, or gate burrs. Mold flash, protrusions, or gate burrs shall not exceed 0.006 (0,15) each side.
 - D. Body width does not include interlead flash. Interlead flash shall not exceed 0.017 (0,43) each side.
 - E. Reference JEDEC MS-012 variation AC.

D (R-PDSO-G16)

PLASTIC SMALL OUTLINE

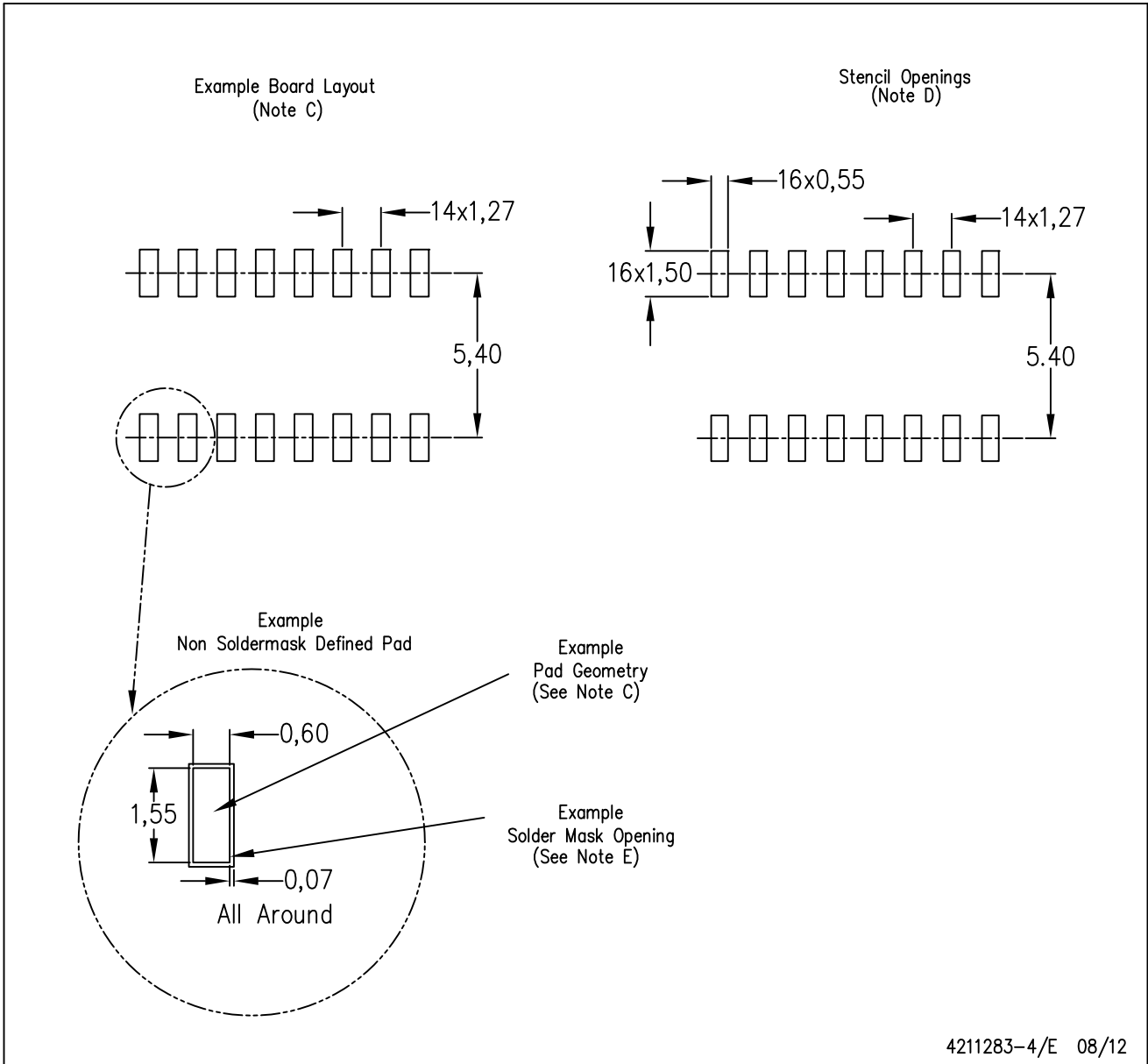

- NOTES:
- All linear dimensions are in millimeters.
 - This drawing is subject to change without notice.
 - Publication IPC-7351 is recommended for alternate designs.
 - Laser cutting apertures with trapezoidal walls and also rounding corners will offer better paste release. Customers should contact their board assembly site for stencil design recommendations. Refer to IPC-7525 for other stencil recommendations.
 - Customers should contact their board fabrication site for solder mask tolerances between and around signal pads.

PW (R-PDSO-G16)

PLASTIC SMALL OUTLINE



4040064-4/G 02/11

- NOTES:
- A. All linear dimensions are in millimeters. Dimensioning and tolerancing per ASME Y14.5M-1994.
 - B. This drawing is subject to change without notice.
 - C. Body length does not include mold flash, protrusions, or gate burrs. Mold flash, protrusions, or gate burrs shall not exceed 0,15 each side.
 - D. Body width does not include interlead flash. Interlead flash shall not exceed 0,25 each side.
 - E. Falls within JEDEC MO-153

PW (R-PDSO-G16)

PLASTIC SMALL OUTLINE



- NOTES:
- All linear dimensions are in millimeters.
 - This drawing is subject to change without notice.
 - Publication IPC-7351 is recommended for alternate designs.
 - Laser cutting apertures with trapezoidal walls and also rounding corners will offer better paste release. Customers should contact their board assembly site for stencil design recommendations. Refer to IPC-7525 for other stencil recommendations.
 - Customers should contact their board fabrication site for solder mask tolerances between and around signal pads.

DB (R-PDSO-G**)

PLASTIC SMALL-OUTLINE

28 PINS SHOWN



- NOTES: A. All linear dimensions are in millimeters.
 B. This drawing is subject to change without notice.
 C. Body dimensions do not include mold flash or protrusion not to exceed 0,15.
 D. Falls within JEDEC MO-150

IMPORTANT NOTICE

Texas Instruments Incorporated and its subsidiaries (TI) reserve the right to make corrections, enhancements, improvements and other changes to its semiconductor products and services per JESD46, latest issue, and to discontinue any product or service per JESD48, latest issue. Buyers should obtain the latest relevant information before placing orders and should verify that such information is current and complete. All semiconductor products (also referred to herein as "components") are sold subject to TI's terms and conditions of sale supplied at the time of order acknowledgment.

TI warrants performance of its components to the specifications applicable at the time of sale, in accordance with the warranty in TI's terms and conditions of sale of semiconductor products. Testing and other quality control techniques are used to the extent TI deems necessary to support this warranty. Except where mandated by applicable law, testing of all parameters of each component is not necessarily performed.

TI assumes no liability for applications assistance or the design of Buyers' products. Buyers are responsible for their products and applications using TI components. To minimize the risks associated with Buyers' products and applications, Buyers should provide adequate design and operating safeguards.

TI does not warrant or represent that any license, either express or implied, is granted under any patent right, copyright, mask work right, or other intellectual property right relating to any combination, machine, or process in which TI components or services are used. Information published by TI regarding third-party products or services does not constitute a license to use such products or services or a warranty or endorsement thereof. Use of such information may require a license from a third party under the patents or other intellectual property of the third party, or a license from TI under the patents or other intellectual property of TI.

Reproduction of significant portions of TI information in TI data books or data sheets is permissible only if reproduction is without alteration and is accompanied by all associated warranties, conditions, limitations, and notices. TI is not responsible or liable for such altered documentation. Information of third parties may be subject to additional restrictions.

Resale of TI components or services with statements different from or beyond the parameters stated by TI for that component or service voids all express and any implied warranties for the associated TI component or service and is an unfair and deceptive business practice. TI is not responsible or liable for any such statements.

Buyer acknowledges and agrees that it is solely responsible for compliance with all legal, regulatory and safety-related requirements concerning its products, and any use of TI components in its applications, notwithstanding any applications-related information or support that may be provided by TI. Buyer represents and agrees that it has all the necessary expertise to create and implement safeguards which anticipate dangerous consequences of failures, monitor failures and their consequences, lessen the likelihood of failures that might cause harm and take appropriate remedial actions. Buyer will fully indemnify TI and its representatives against any damages arising out of the use of any TI components in safety-critical applications.

In some cases, TI components may be promoted specifically to facilitate safety-related applications. With such components, TI's goal is to help enable customers to design and create their own end-product solutions that meet applicable functional safety standards and requirements. Nonetheless, such components are subject to these terms.

No TI components are authorized for use in FDA Class III (or similar life-critical medical equipment) unless authorized officers of the parties have executed a special agreement specifically governing such use.

Only those TI components which TI has specifically designated as military grade or "enhanced plastic" are designed and intended for use in military/aerospace applications or environments. Buyer acknowledges and agrees that any military or aerospace use of TI components which have **not** been so designated is solely at the Buyer's risk, and that Buyer is solely responsible for compliance with all legal and regulatory requirements in connection with such use.

TI has specifically designated certain components as meeting ISO/TS16949 requirements, mainly for automotive use. In any case of use of non-designated products, TI will not be responsible for any failure to meet ISO/TS16949.

Products

| | |
|------------------------------|--|
| Audio | www.ti.com/audio |
| Amplifiers | amplifier.ti.com |
| Data Converters | dataconverter.ti.com |
| DLP® Products | www.dlp.com |
| DSP | dsp.ti.com |
| Clocks and Timers | www.ti.com/clocks |
| Interface | interface.ti.com |
| Logic | logic.ti.com |
| Power Mgmt | power.ti.com |
| Microcontrollers | microcontroller.ti.com |
| RFID | www.ti-rfid.com |
| OMAP Applications Processors | www.ti.com/omap |
| Wireless Connectivity | www.ti.com/wirelessconnectivity |

Applications

| | |
|-------------------------------|--|
| Automotive and Transportation | www.ti.com/automotive |
| Communications and Telecom | www.ti.com/communications |
| Computers and Peripherals | www.ti.com/computers |
| Consumer Electronics | www.ti.com/consumer-apps |
| Energy and Lighting | www.ti.com/energy |
| Industrial | www.ti.com/industrial |
| Medical | www.ti.com/medical |
| Security | www.ti.com/security |
| Space, Avionics and Defense | www.ti.com/space-avionics-defense |
| Video and Imaging | www.ti.com/video |

TI E2E Community

e2e.ti.com