

# EVF463

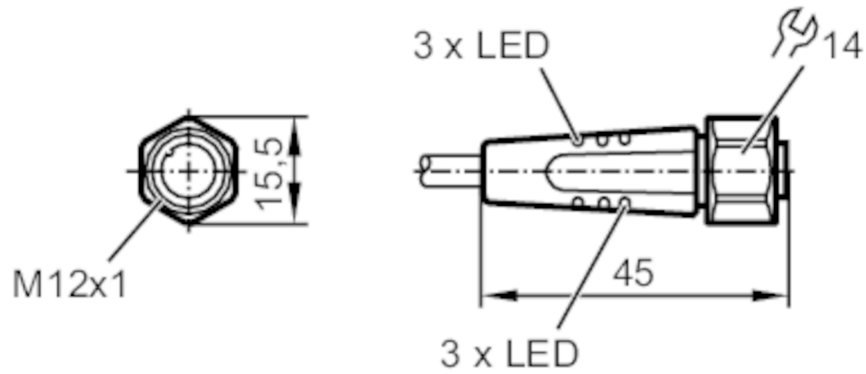

## Connecting cable with socket

ADOGH046VAS0010P04



### Application

Special feature	Free from silicone; Halogen-free; Gold-plated contacts; Drag chain suitability
Application	hygienic and wet areas in the food industry
Free from silicone	yes

### Electrical data

Operating voltage	[V]	10...36 DC
Protection class		II
Max. current load total	[A]	4

### Outputs

Electrical design	PNP
-------------------	-----

### Operating conditions

Ambient temperature	[°C]	-25...100
Ambient temperature (moving)	[°C]	5...100
Protection		IP 65; IP 67; IP 68; IP 69K

# EVF463



## Connecting cable with socket

ADOGH046VAS0010P04

Mechanical data		
Weight [g]	320.2	
Dimensions [mm]	15.5 x 15.5 x 45	
Materials	housing: PP Halogen-free; Sealing: EPDM	
Material nut	stainless steel (1.4404 / 316L)	
Drag chain suitability	yes	
Drag chain suitability	bending radius for flexible use	min. 10 x cable diameter
	travel speed	max. 3.3 m/s for a horizontal travel length of 5 m and max. acceleration of 5 m/s <sup>2</sup>
	bending cycles	> 1 Mio.
	torsional strain	± 180 °/m

Displays / operating elements		
Display	switching status	4 x LED, yellow
	operation	2 x LED, green

Remarks	
Pack quantity	1 pcs.

Electrical connection	
Cable: 10 m, MPPE, Halogen-free, orange, Ø 4.9 mm; 4 x 0.34 mm <sup>2</sup> (42 x Ø 0.1 mm )	

Electrical connection - socket	
Connector: 1 x M12, straight; Locking: stainless steel (1.4404 / 316L); Contacts: gold-plated; Tightening torque: 0.6...1.5 Nm	

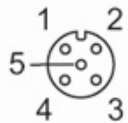

# EVF463



## Connecting cable with socket

ADOGH046VAS0010P04

### Connection

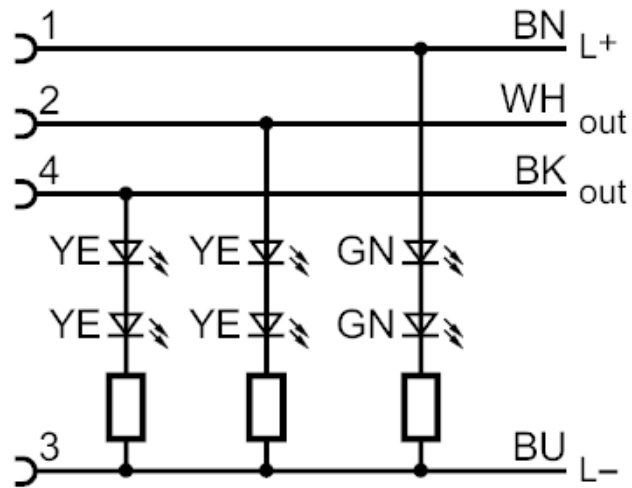

#### Core colours

BK	black
BN	brown
BU	blue
WH	white