

A519

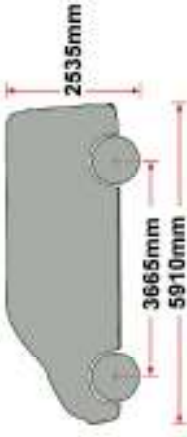

SPRINTER/CRAFTER 2006- L2, H1, TWIN DOORS



AMP20 + AMP20 = 4.0m

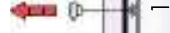
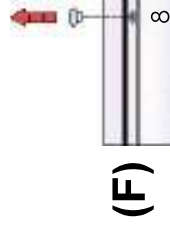
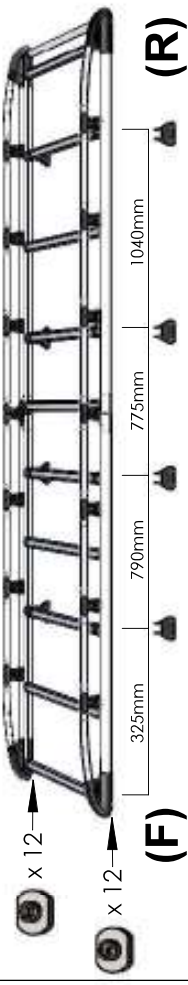

(F)

(R)

8

7

6

5

4

3

2

1



EXT09-004 x 8



MS168 x 8



PS095 x 8



PS089 x 1



PS090 x 1



PS023 x 8

(1:1)



FB003 (M8 x 65) x 16

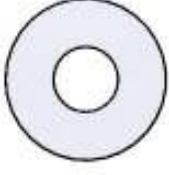

FW002 (M8) x 40



FN006 (M8) x 26



FS015 (M8 x 25) x 8



PS020 x 8

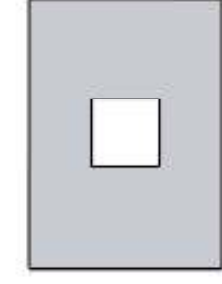

MS209 x 8



FS059 (M8 x 25) x 30

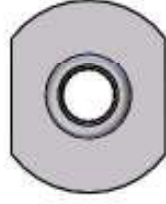

FN023 (M8) x 24

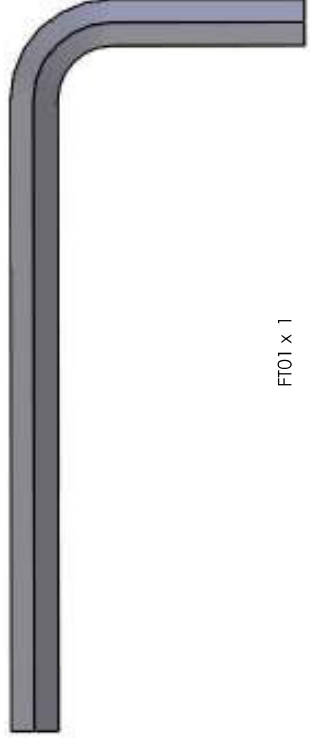

FT01 x 1

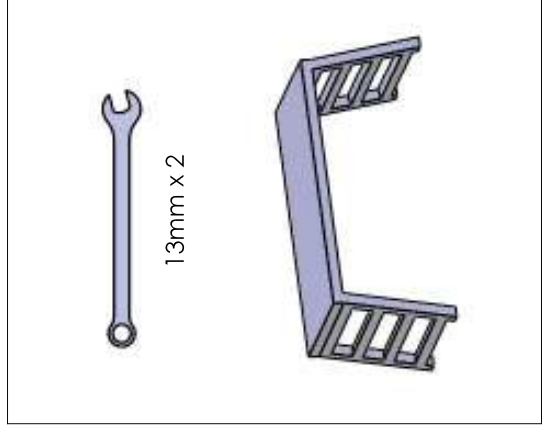

13mm x 2

