



ACCES.F.FUSE SWI. DISCONNECTOR FOR NH1  
 FUSE CARRIER WITH FUSE MONITORING  
 ELECTRONIC, EFM 20

Figure similar

Model	
product brand name	SENTRON
Design of the product	for 3NP1 fuse switch disconnectors, fuse carrier with EFM20 electronic fuse monitoring, for size NH1

Accessories	
accessories	cover

General Product Approval	Declaration of Conformity	Test Certificates
--------------------------	---------------------------	-------------------



[Type Test Certificates/Test Report](#)

### Further information

**Information- and Downloadcenter (Catalogs, Brochures,...)**

<http://www.siemens.com/lowvoltage/catalogs>

**Industry Mall (Online ordering system)**

<https://eb.automation.siemens.com/mall/en/WW/Catalog/Product/3NP19431GB30>

**Service&Support (Manuals, Certificates, Characteristics, FAQs,...)**

<http://support.automation.siemens.com/WW/view/en/3NP19431GB30/all>

**Image database (product images, 2D dimension drawings, 3D models, device circuit diagrams, ...)**

[http://www.automation.siemens.com/bilddb/cax\\_en.aspx?mfb=3NP19431GB30](http://www.automation.siemens.com/bilddb/cax_en.aspx?mfb=3NP19431GB30)

**CAX-Online-Generator**

<http://www.siemens.com/cax>

**Tender specifications**

<http://ausschreibungstexte.siemens.com/tiplv>

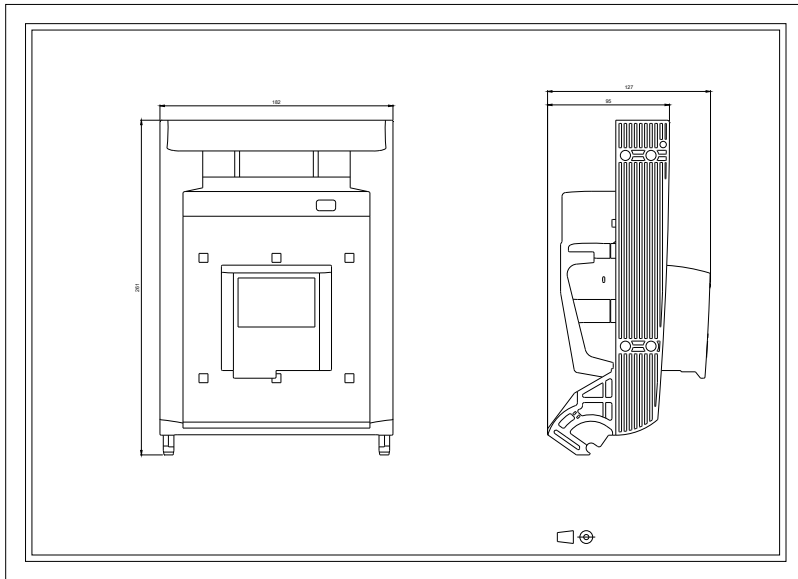

last modified:

11.03.2015